

2731TRUC-91

CHEVROLET

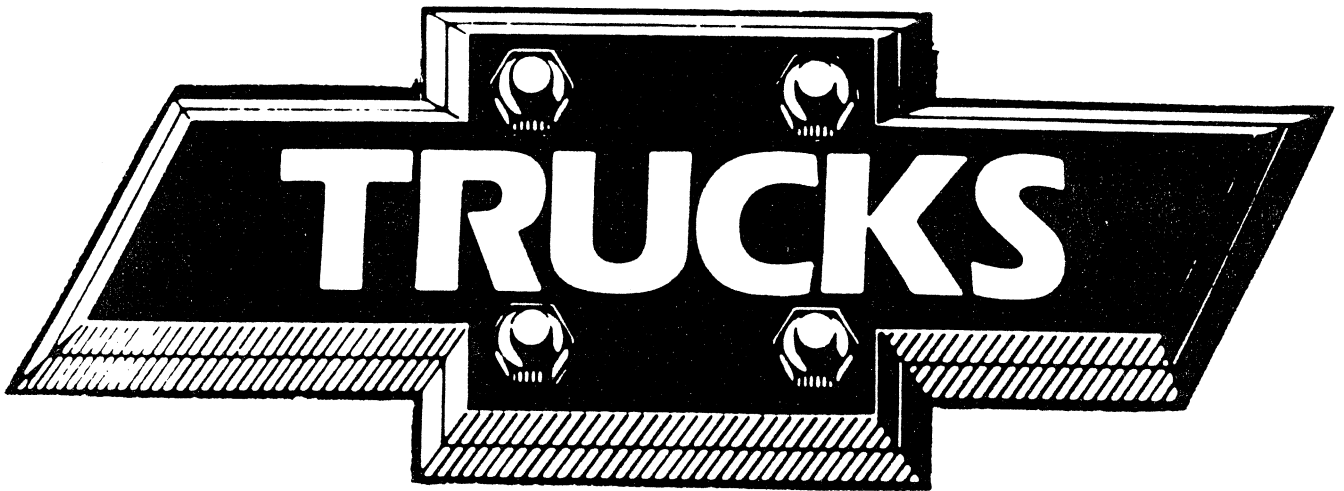

1991

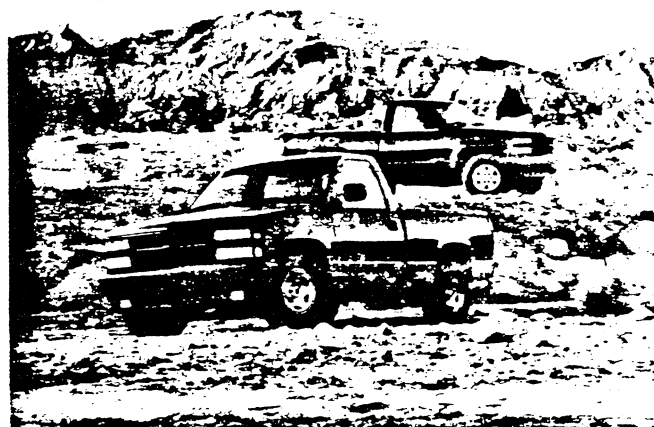

CONTENTS

	<u>Page</u>
MODELS	2
WT 1500 WORK TRUCK (VLA) TRIM	6
CHEYENNE (STANDARD) TRIM	7
SCOTTSDALE (Z62) TRIM	8
SILVERADO (YE9) TRIM	9
454 SS (B4U) TRIM	10
POWERTRAINS	11
STANDARD SUSPENSION (TWO-WHEEL DRIVE MODELS)	18
OPTIONAL SUSPENSION (FOUR-WHEEL DRIVE MODELS)	19
STANDARD SUSPENSION (TWO-WHEEL DRIVE MODELS)	20
OPTIONAL SUSPENSION (FOUR-WHEEL DRIVE MODELS)	21
WHEELS AND TIRES	22
FRAME/STEERING/BRAKES	26
ELECTRICAL	28
COOLING	29
DIMENSIONS	30
OPTIONS	33
COLOR COMBINATIONS	38
EXTERIOR COLORS	B
INTERIOR TRIM	C
SEATS	D
TRAILERING	E

†: Red Print Indicates Not Available in California **Bold Print** Indicates Not Available w/High Altitude Emissions

FRONT WHEEL DRIVE MODELS

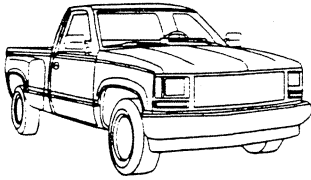
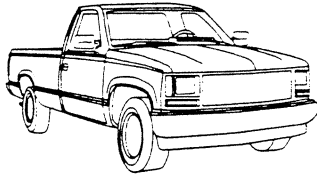
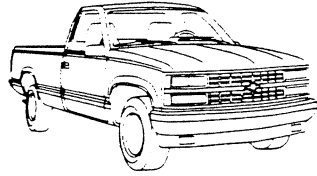
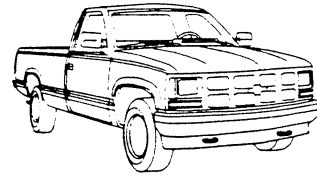
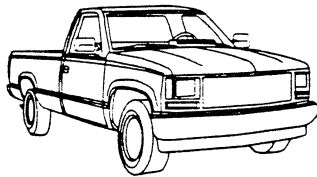
C1500 REGULAR CAB SPORTSIDE	MODEL NUMBER	BOX (FT.)	GVWR (LBS.)	MAX ¹ PAYLOAD (LBS.)	PASS. CAP. (STD/OPT)	STD ENGINE/ TRANS	OPT ENGINE/ TRANS	
		CC10703/E62	6.5	5600	1879	3/2	4.3L V6/M5	4.3L V6/A4 5.0L V8/M5/A4 5.7L V8/M5/A4
C1500 REGULAR CAB FLEETSIDE	MODEL NUMBER	BOX (FT.)	GVWR (LBS.)	MAX ¹ PAYLOAD (LBS.)	PASS. CAP. (STD/OPT)	STD ENGINE/ TRANS	OPT ENGINE/ TRANS	
		CC10703/E63	6.5	5600	1899	3/2	4.3L V6/M5	4.3L V6/A4 5.0L V8/M5/A4 5.7L V8/M5/A4
C1500 REGULAR CAB FLEETSIDE 454 SS (B4U)	MODEL NUMBER	BOX (FT.)	GVWR (LBS.)	MAX ¹ PAYLOAD (LBS.)	PASS. CAP. (STD/OPT)	STD ENGINE/ TRANS	OPT ENGINE/ TRANS	
		CC10703/E63/B4U	6.5	5600	1603	2/-	7.4L V8/A4	—
C1500 REGULAR CAB FLEETSIDE WT 1500 (VLA)	MODEL NUMBER	BOX (FT.)	GVWR (LBS.)	MAX ¹ PAYLOAD (LBS.)	PASS. CAP. (STD/OPT)	STD ENGINE/ TRANS	OPT ENGINE/ TRANS	
		CC10903/E63/VLA	8	5600	1766	3/-	4.3L V6/M5	4.3L V6/A4
		CC10903/E63/VLA/F44	8	6100	2554	3/-	4.3L V6/M5	4.3L V6/A4
C1500 REGULAR CAB FLEETSIDE	MODEL NUMBER	BOX (FT.)	GVWR (LBS.)	MAX ¹ PAYLOAD (LBS.)	PASS. CAP. (STD/OPT)	STD ENGINE/ TRANS	OPT ENGINE/ TRANS	
		CC10903/E63	8	5600	1762	3/2	4.3L V6/M5	4.3L V6/M4/A4 5.0L V8/M5/A4 5.7L V8/M4/M5 A4
		CC10903/E63/B3J	8	6100	1741	3/2	6.2L V8/M4	6.2L V8/A4
		CC10903/E63/F44	8	6100	2250	3/2	4.3L V6/M5	4.3L V6/M4/A4 5.0L V8/M5/A4 5.7L V8/M4/M5/A4

C1500 REGULAR CAB SPORTSIDE
The Sportside features a specialized cargo-bed design with a fully-rectangular cargo box on the inside, and fiberglass side panels flanked by running board steps on the outside.

C1500 REGULAR CAB FLEETSIDE
The C1500 Fleetside is the most popular full-size model with a 6.5-foot cargo box and a variety of powertrains and GVWRs to meet the needs of today's truck buyers.

C1500 REGULAR CAB FLEETSIDE 454 SS (B4U)
The 454 SS is available with a 7.4L V8 engine, high performance capabilities, and increased comfort to meet the needs of today's sport-truck buyer.

C1500 REGULAR CAB FLEETSIDE WT 1500 (VLA)
The WT 1500 (VLA) is an economy model for price-conscious buyers. It is offered with an 8-foot cargo box, one trim level, two GVWRs and limited option availability.

C1500 REGULAR CAB FLEETSIDE
The C1500 Fleetside is the most popular full-size model. It's available with an 8-foot cargo box and a variety of powertrains and two GVWRs to meet the needs of today's truck buyers.

¹Based on Curb Weight.

MODELS

Key: Red Print Indicates Not Available in California **Bold Print** Indicates Not Available w/High Altitude Emissions

1991
C/K PICKUP

REAR WHEEL DRIVE MODELS

C1500 EXTENDED CAB FLEETSIDE

The C1500 Extended Cab model offers a cab design with a generous amount of secure in-cab storage behind the front seat and a choice of a 6.5-foot or an 8-foot cargo box. An optional three-passenger rear seat is available.

C1500 EXTENDED CAB FLEETSIDE

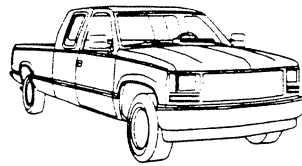

MODEL NUMBER	BOX (FT.)	GVWR (LBS.)	MAX' PAYLOAD (LBS.)	PASS. CAP. (STD/OPT)	STD ENGINE/ TRANS	OPT ENGINE/ TRANS
CC10753/E63	6.5	6200	2150	3/5/6	4.3L V6/M5	4.3L V6/M4 A4 5.0L V8/M5/A4 5.7L V8/M4/M5 A4
CC10753/E63 B3J	6.5	6200	2080	3/5/6	6.2L V8/M4	6.2L V8 A4
CC10953/E63	8	6200	2048	3/5/6	4.3L V6/M5	4.3L V6/M4 A4 5.0L V8/M5/A4 5.7 V8/M4/M5 A4
CC10953/E63 B3J	8	6200	1612	3/5/6	6.2L V8/M4	6.2L V8 A4

C2500 REGULAR CAB FLEETSIDE

The C2500 Regular Cab offers increased GVWR capacity over the C1500 series.²

C2500 REGULAR CAB FLEETSIDE

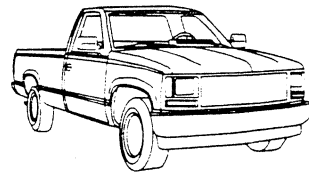

MODEL NUMBER	BOX (FT.)	GVWR (LBS.)	MAX' PAYLOAD (LBS.)	PASS. CAP. (STD/OPT)	STD ENGINE/ TRANS	OPT ENGINE/ TRANS
CC20903/E63	8	7200	3198	3/2	4.3L V6/M5	4.3L V6/M4/A4 5.0L V8/M5/A4 5.7L V8/M4/M5 A4
CC20903/E63 B3J	8	7200	2608	3/2	6.2L V8/M4	6.2L V8 A4
CC20903/E63/C6P	8	8600	4368	3/2	4.3L V6/M4	4.3L V6/A4 5.7L V8/M4/A4 7.4L V8/M4/A4
CC20903/E63/B3J/C6P	8	8600	3617	3/2	6.2L V8/M4	6.2L V8/A4

C2500 EXTENDED CAB FLEETSIDE

The C2500 Extended Cab offers the versatility of extended cab design coupled with the GVWR availability of the C2500 series. It is available with a 6.5-foot or an 8-foot cargo box.²

C2500 EXTENDED CAB FLEETSIDE

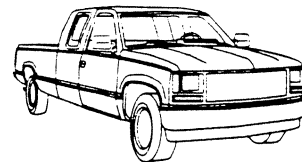

MODEL NUMBER	BOX (FT.)	GVWR (LBS.)	MAX' PAYLOAD (LBS.)	PASS. CAP. (STD/OPT)	STD ENGINE/ TRANS	OPT ENGINE/ TRANS
CC20753/E63	6.5	7200	3039	3/5/6	4.3L V6/M5	4.3L V6/M4 A4 5.0L V8/M5/A4 5.7 V8/M4/M5 A4
CC20753/E63 B3J	6.5	7200	2217	3/5/6	6.2L V8/M4	6.2L V8 A4
CC20953/E63	8	7200	2933	3/5/6	4.3L V6/M5	4.3L V6/M4/A4 5.0L V8/M5/A4 5.7L V8/M4/M5 A4
CC20953/E63/B3J	8	7200	2425	3/5/6	6.2L V8/M4	6.2L V8 A4
CC20953/E63/C6P	8	8600	4073	3/5/6	4.3L V6/M4	4.3L V6/A4 5.7L V8/M4/A4 7.4L V8/M4/A4
CC20953/E63/B3J/C6P	8	8600	3413	3/5/6	6.2L V8/M4	6.2L V8/A4

C3500 REGULAR CAB BIG DOOLEY w/DUAL REAR WHEELS

The C3500 Big Dooley offers the highest GVWR available in the C/K Pickup series. The Big Dooley is equipped with dual rear wheels and plastic rear fender extensions.²

C3500 BIG DOOLEY

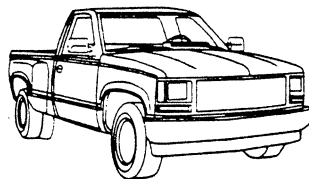

MODEL NUMBER	BOX (FT.)	GVWR (LBS.)	MAX' PAYLOAD (LBS.)	PASS. CAP. (STD/OPT)	STD ENGINE/ TRANS	OPT ENGINE/ TRANS
CC30903/E63	8	10,000	5055	3/2	5.7L V8/M4	5.7L V8/M4/A4 7.4L V8/M4/A4
CC30903/E63/B3J	8	10,000	5110	3/2	6.2L V8/M4	6.2L V8/A4

C3500 EXTENDED CAB BIG DOOLEY w/Dual REAR WHEELS

The C3500 Extended Cab Big Dooley w/Dual Rear Wheels offers the versatility of extended cab design and high GVWR, as well as plastic rear fender extensions.²

C3500 BIG DOOLEY

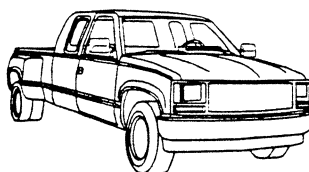

MODEL NUMBER	BOX (FT.)	GVWR (LBS.)	MAX' PAYLOAD (LBS.)	PASS. CAP. (STD/OPT)	STD ENGINE/ TRANS.	OPT. ENGINE/ TRANS.
CC30953/E63	8	10,000	4757	3/5/6	5.7L V8/M4	5.7L V8/A4 7.4L V8/M4/A4
CC30953/E63/B3J	8	10,000	4458	3/5/6	6.2L V8/M4	6.2L V8/A4

¹Based on Curb Weight.

²Models at or above 8600 lbs. GVWR do not include air dam.

Y: Red Print Indicates Not Available in California Bold Print Indicates Not Available w/High Altitude Emissions

FOUR-WHEEL DRIVE MODELS

K1500 REGULAR CAB SPORTSIDE

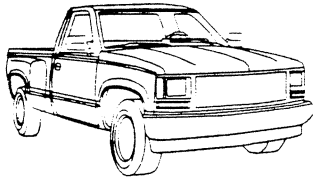

MODEL NUMBER	BOX (FT.)	GVWR (LBS.)	MAX' PAYLOAD (LBS.)	PASS. CAP. (STD/OPT)	STD ENGINE/ TRANS	OPT ENGINE/ TRANS
CK10703/E62	6.5	5600	1459	3/2	4.3L V6/M5	4.3L V6/A4 5.0L V8/M5/A4 5.7L V8/M4/M5/A4
CK10703/E62/F44	6.5	6100	1935	3/2	4.3L V6/M5	4.3L V6/M4/A4 5.0L V8/M5/A4 5.7L V8/M4/M5/A4

K1500 REGULAR CAB SPORTSIDE
The Sportside features a specialized cargo-bed design with a fully-rectangular cargo box on the inside, and fiberglass side panels flanked by running board steps on the outside.

K1500 REGULAR CAB FLEETSIDE

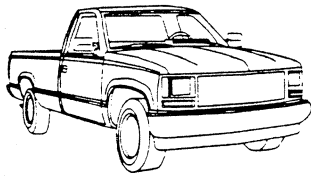

MODEL NUMBER	BOX (FT.)	GVWR (LBS.)	MAX' PAYLOAD (LBS.)	PASS. CAP. (STD/OPT)	STD ENGINE/ TRANS	OPT ENGINE/ TRANS
CK10703/E63	6.5	5600	1489	3/2	4.3L V6/M5	4.3L V6/M4/A4 5.0L V8/M5/A4 5.7L V8/M4/M5/A4
CK10703/E63/F44	6.5	6100	1968	3/2	4.3L V6/M5	4.3L V6/M4/A4 5.0L V8/M5/A4 5.7L V8/M4/M5/A4

K1500 REGULAR CAB FLEETSIDE
The K1500 Fleetside is the most popular full-size model. It's available with a 6.5-foot cargo box and a variety of powertrains and two GVWRs to meet the needs of today's truck buyer.

K1500 REGULAR CAB FLEETSIDE WT 1500 (VLA)

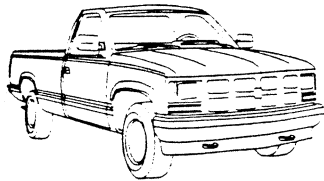

MODEL NUMBER	BOX (FT.)	GVWR (LBS.)	MAX' PAYLOAD (LBS.)	PASS. CAP. (STD/OPT)	STD ENGINE/ TRANS	OPT ENGINE/ TRANS
CK10903/E63/VLA	8	5600	1340	3/2	4.3L V6/M5	4.3L V6/A4
CK10903/E63/VLA/F44	8	6100	1819	3/2	4.3L V6/M5	4.3L V6/A4

K1500 REGULAR CAB FLEETSIDE WT 1500 (VLA)
The WT 1500 (VLA) is an economy model for price-conscious buyers. It is offered with an 8-foot cargo box, one trim level, two GVWRs and limited option availability.

K1500 REGULAR CAB FLEETSIDE

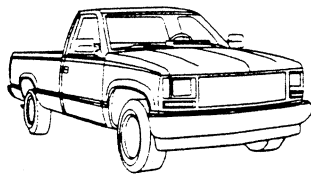

MODEL NUMBER	BOX (FT.)	GVWR (LBS.)	MAX' PAYLOAD (LBS.)	PASS. CAP. (STD/OPT)	STD ENGINE/ TRANS	OPT ENGINE/ TRANS
CK10903/E63	8	5600	1336	3/2	4.3L V6/M5	4.3L V6/M4/A4 5.0L V8/M5/A4 5.7L V8/M4/M5/A4
CK10903/E63/B3J	8	6100	1440	3/2	6.2L V8/M5	6.2L V8/A4
CK10903/E63/F44	8	6100	1817	3/2	4.3L V6/M5	4.3L V6/M4/A4 5.0L V8/M5/A4 5.7L V8/M4/M5/A4

K1500 REGULAR CAB FLEETSIDE WT 1500
The K1500 Fleetside is the most popular full-size model. It's available with an 8-foot cargo box, a variety of powertrains and two GVWRs to meet the needs of today's truck buyer.

K1500 EXTENDED CAB FLEETSIDE

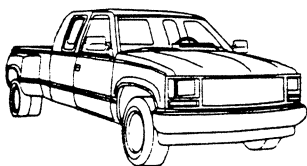

MODEL NUMBER	BOX (FT.)	GVWR (LBS.)	MAX' PAYLOAD (LBS.)	PASS. CAP. (STD/OPT)	STD ENGINE/ TRANS	OPT ENGINE/ TRANS
CK10753/E63	6.5	6200	1750	3/5/6	4.3L V6/M5	4.3L V6/M4/A4 5.0L V8/M5/A4 5.7L V8/M4/M5/A4
CK10753/E63/B3J	6.5	6600	1572	3/5/6	6.2L V8/M4	6.2L V8/A4
CK10753/E63/F44	6.5	6600	1639	3/5/6	4.3L V6/M5	4.3L V6/M4/A4 5.0L V8/M5/A4 5.7L V8/M4/M5/A4
CK10953/E63	8	6200	1615	3/5/6	4.3L V6/M5	4.3L V6/M4/A4 5.0L V8/M5/A4 5.7L V8/M4/M5/A4
CK10953/E63/B3J	8	6600	1431	3/5/6	6.2L V8 M4	6.2L V8/A4
CK10953/E63/F44	8	6600	1994	3/5/6	4.3L V6/M5	4.3L V6/M4/A4 5.0L V8/M5/A4 5.7L V8/M4/M5/A4

K1500 EXTENDED CAB FLEETSIDE
The K1500 Extended Cab offers a cab design with a generous amount of secure in-cab storage behind the front seat and a choice of a 6.5-foot or an 8-foot cargo box. An optional three-passenger rear seat is available.

Based on Curb Weight.

FOUR-WHEEL DRIVE MODELS

K2500 REGULAR CAB FLEETSIDE

The K2500 Regular Cab offers increased GVWR capacity over the K1500 series.²

K2500 REGULAR CAB FLEETSIDE

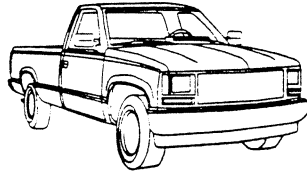

MODEL NUMBER	BOX (FT.)	GVWR (LBS.)	MAX ¹ PAYLOAD (LBS.)	PASS. CAP. (STD/OPT)	STD ENGINE/ TRANS	OPT ENGINE/ TRANS
CK20903/E63	8	7200	2848	3/2	4.3L V6/M5	4.3L V6/M4 A4 5.0L V8/M5 A4 5.7L V8/M4/M5 A4
CK20903 E63/B3J	8	7200	2339	3/2	6.2L V8/M4	6.2L V8 A4
CK20903/E63/C6P	8	8600	4000	3/2	4.3L V6/M4	4.3L V6 A4 5.7L V8/M4 A4 7.4L V8/M4 A4
CK20903/E63/B3J/C6P	8	8600	3739	3/2	6.2L V8/M4	6.2L V8/A4

K2500 EXTENDED CAB FLEETSIDE

The K2500 Extended Cab offers the versatility of extended cab design coupled with the GVWR availability of the K2500 series. It is available with a 6.5-foot or an 8-foot cargo box.²

K2500 EXTENDED CAB FLEETSIDE

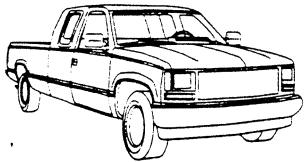

MODEL NUMBER	BOX (FT.)	GVWR (LBS.)	MAX ¹ PAYLOAD (LBS.)	PASS. CAP. (STD/OPT)	STD ENGINE/ TRANS	OPT ENGINE/ TRANS
CK20753/E63	6.5	7200	2719	3/5/6	4.3L V6/M5	4.3L V6/M4 A4 5.0L V8/M5 A4 5.7L V8/M4/M5 A4
CK20753 E63 B3J	6.5	7200	2817	3/5/6	6.2L V8/M4	6.2L V8 A4
CK20953/E63	8	7200	2511	3/5/6	4.3L V6/M5	4.3L V6/M4 A4 5.0L V8/M5 A4 5.7L V8/M4/M5 A4
CK20953 E63 B3J	8	7200	1668	3/5/6	6.2L V8/M4	6.2L V8 A4
CK20953/E63/C6P	8	8600	3628	3/5/6	4.3L V6/M4	4.3L V6 A4 5.7L V8/M4 A4 7.4L V8/M4 A4
CK20953/E63/B3J/C6P	8	8600	3739	3/5/6	6.2L V8/M4	6.2L V8/A4

K3500 REGULAR CAB BIG DOOLEY w/DUAL REAR WHEELS

The K3500 Big Dooley offers the highest GVWR available in the C/K Pickup series, as well as dual rear wheels and plastic rear fender extensions.²

K3500 REGULAR CAB BIG DOOLEY

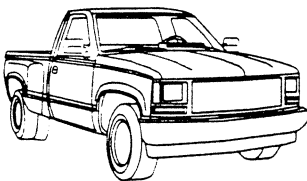

MODEL NUMBER	BOX (FT.)	GVWR (LBS.)	MAX ¹ PAYLOAD (LBS.)	PASS. CAP. (STD/OPT)	STD ENGINE/ TRANS	OPT ENGINE/ TRANS
CK30903/E63	8	10,000	4684	3/2	5.7L V8/M4	5.7L V8/A4 7.4L V8/M4 A4
CK30903/E63/B3J/	8	10,000	4739	3/2	6.2L V8/M4	6.2L V8/A4

K3500 EXTENDED CAB BIG DOOLEY w/DUAL REAR WHEELS

The K3500 Extended Cab Big Dooley w/dual rear wheels offers the versatility of extended cab design, high GVWR, as well as plastic rear fender extensions.²

K3500 EXTENDED CAB BIG DOOLEY

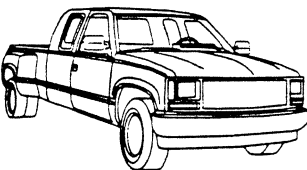

MODEL NUMBER	BOX (FT.)	GVWR (LBS.)	MAX ¹ PAYLOAD (LBS.)	PASS. CAP. (STD/OPT)	STD ENGINE/ TRANS	OPT ENGINE/ TRANS
CK30953/E63	8	10,000	4347	3/5/6	5.7L V8/M4	5.7L V8/A4 7.4L V8/M4 A4
CK30953/E63/B3J/	8	10,000	4468	3/5/6	6.2L V8/M4	6.2L V8/A4

¹Based on Curb Weight.

²Models at or above 8600 lbs. GVWR do not include air dam.

WT 1500 WORK TRUCK (VLA)

The "WT" 1500 Regular Cab Work Truck (VLA) is available as a C/K 10903 Fleetside with Cheyenne trim only and has limited option availability.

The following features are standard.



Some equipment shown may be optional or extra cost.

POWERTRAIN/CHASSIS

- ALTERNATOR: 85 Amp Delcotron.
- BATTERY: 12 volt, neg. ground; 630 CCA @ 0 degrees F.
- BRAKES: Power: vacuum. Front—disc. Rear—drum. Includes rear wheel anti-lock braking system.
- ENGINE: 4.3-liter V6 (EFI). 160 net HP @ 4000 rpm and 235 lb. ft. of net torque @ 2400 rpm.
- EXHAUST: Single.
- FRAME: All-welded ladder-type, channel design and boxed front-end section.
- FUEL TANK: 34.0 gallon (approx.)
- REAR AXLE: Hypoid, Semi-Floating. Axle ratio: 3.08:1
- SHOCK ABSORBERS: —25 mm piston dia. front and rear.
- STABILIZER BAR: Front—1.25 inch diameter on 2-wheel drive models and 1.18 inch diameter on 4-wheel drive models.
- STEERING: Integral Power. Ratio—16/13:1.
- SUSPENSION: Front—Independent with computer-selected springs. Two-wheel drives with coil springs, four-wheel drives with torsion bars. Rear—Semi Elliptic two-stage multi-leaf springs.
- TOW HOOKS: Two front on 4-wheel drives.
- TRANSMISSION: Manual 5-speed with overdrive.

EXTERIOR

- AIR DAM: Dark argent metallic.
- BODY SIDE DECALS: "W/T1500" with integrated bow tie.
- BUMPER: Dark argent metallic front.
- COLORS: Choice of four in a solid paint scheme.
 - Smoke Blue Metallic
 - Summit White
 - Flame Red
 - Quicksilver Metallic
- GRILLE: Impact resistant, dark argent metallic.
- HEADLAMPS: Single rectangular halogen.
- HORN: Single electric low-note.
- MIRRORS: Black RH and LH below-eye-line type with adjustable heads. Head size is 9.0" x 6.5".
- NAMEPLATE: Cheyenne.
- PICKUP BOX: All-welded 8-foot, double wall construction and extensive corrosion protection throughout.
- SPARE TIRE: Delete.
- SPARE TIRE CARRIER: Delete.
- TIRES: Four steel-belted radial tires. P225/75R15 tires on the 2-wheel drives and LT225/75R16C on the 4-wheel drives.
- WHEELS: Four silver painted steel wheels with black hub ornament; 15.0" x 6.0" on 2-wheel drives and 16.0" x 6.5" on 4-wheel drives.

INTERIOR

- ARMREST: RH and LH padded; integral with door panels.
- CIGARETTE LIGHTER.
- COAT HOOK: RH.
- COLORS: Choice of five interior. See Color and Trim specifications for details.
- DOME LAMP: Switch in LH door jamb.
- DOOR PANELS: Grained molded plastic.
- DOOR SILL PLATE: Gray.
- FLOOR COVERING: Embossed black rubber mat.
- GAGES: Including speedometer, odometer, fuel level, voltmeter, temperature, oil pressure and additional telltale lights.
- GLOVE BOX: Latched door and beverage holder.
- HEADLINER: Vinyl with matching retainer moldings.
- HEATER: Deluxe with windshield and side window defoggers.
- INSULATION: Provided on dash panel, cowl top and sides, and doors.
- MIRROR: 10-inch rearview.
- RADIO: Delete.
- SEATS: 3-passenger all-vinyl trim front bench with folding backrest.
- STEERING WHEEL: Custom urethane 4-spoke.
- SUNSHADES: Color-keyed vinyl RH and LH padded.
- TOOLS: Mechanical jack and wheel wrench located behind front seat.
- WINDOWS: Tinted glass.
- WINDSHIELD WIPERS: Intermittent.

CHEYENNE

(STANDARD)

The Cheyenne trim level is the standard trim level of the C/K series. It is designed to offer truck buyers a high level of standard features when they purchase a standard-level truck.

The following features are standard. Bold type denotes features in addition to or replacing that of the Work Truck trim.



Some equipment shown may be optional or extra cost.

POWERTRAIN/CHASSIS

- ALTERNATOR: 85 Amp Delcotron.
- BATTERY: Gas engines—12 volt, neg. ground; 630 CCA @ 0 degrees F. Diesel engines—Two 12 volt, neg. ground; 570 CCA @ 0 degrees F.
- BRAKES: Power; vacuum. Front—disc. Rear—drum. (except C/K3500) Includes rear wheel anti-lock braking system. C/K3500—Power; hydraulic. Front—disc. Rear—drum. Includes rear wheel anti-lock braking system.
- ENGINE: 4.3-liter V6 (EFI) on C/K1500 and 7200-lb. GVWR C/K2500. 160 net HP @ 4000 rpm and 235 lb. ft. of net torque @ 2400 rpm. Heavy-Duty 4.3-liter V6 EFI on C/K2500 at 8600-lb GVWR. 150 net HP @ 4000 rpm and 230 lb. ft. of net torque @ 2400 rpm. 6.2-liter V8 diesel, mechanical fuel injection, is available with B3J diesel

- equipment (see Powertrains for details). 5.7-liter V8 EFI on C/K3500. 190 net HP @ 4000 rpm and 300 lb. ft. of net torque @ 2400 rpm.
- EXHAUST: Single.
- FRAME: All-welded ladder-type, channel design and boxed front-end section.
- FUEL TANK: 25.0-gallon (approx.) on C/K10703, C/K10753 and C/K20753. 34.0-gallon (approx.) on C/K10903, C/K10953, C/K20903, C/K20953 and C/K3500.
- REAR AXLE: Hypoid, Semi-Floating on C/K1500, and 2500. Standard axle ratio varies. Hypoid, Full-Floating type on C/K3500. Standard axle ratio varies.
- SHOCK ABSORBERS: —25 mm piston dia. front and rear on C/K1500. —32 mm piston dia. front on C/K2500 at 7200 lbs. GVWR and C/K3500. Also,

- rear on C/K2500 and 3500. —35 mm piston dia. front on C/K2500 at 8600 lbs. GVWR.
- STABILIZER BAR: Front—1.25 inch diameter on 2-wheel drive models and 1.18 inch diameter on 4-wheel drive models.
- STEERING: Integral Power. Ratio—16/13:1.
- SUSPENSION: Front—Independent with computer-selected springs. Two-wheel drives with coil springs; four-wheel drives with torsion bars. Rear—Multi-Leaf springs; Semi-Elliptic two-stage on all models except C/K3500. Combined Semi-Elliptic two stage Main/Auxiliary on C/K3500.
- TOW HOOKS: Two front on 4-wheel drives.
- TRANSMISSION: Manual (4-speed or 5-speed depending on model; see Powertrains section for details).

EXTERIOR

- AIR DAM: Black. (Not included on models at or above 8600 lbs. GVWR).
- BUMPER: Chromed front (a rear bumper is available as an option only).
- COLORS: Choice of ten in a solid paint scheme. See Color and Trim specifications for details.
- GRILLE: Light argent molded plastic with dark argent air intake areas.
- HEADLAMPS: Single rectangular halogen.
- HORN: Single electric low-note.
- MIRRORS: Black RH and LH below-eye-

- line type with adjustable heads. Head size is 9.0" x 6.5".
- NAMEPLATE: Cheyenne.
- PICKUP BOX: All-welded double wall construction and extensive corrosion protection throughout.
- SPARE TIRE/WHEEL: Full-size on C/K1500 only (optional on C/K2500 and 3500).
- SPARE TIRE CARRIER: Winch-type mounted under frame at rear on C/K1500 only.

- TIRES: Four steel-belted radials. (Tire size varies with model. See Wheels and Tires for details).
- TOW HOOKS: Two front on 4-wheel drives.
- WHEELS: Four silver painted steel wheels with black hub ornament. (Wheel size varies with model. See Wheels and Tires for details).
- WHEEL OPENING FLARES: Black on K2500 C6P and K3500. (Dual rear wheel models have front flares only).

INTERIOR

- ARMREST: RH and LH padded; integral with door panels.
- CIGARETTE LIGHTER.
- COAT HOOK: RH. Ext. cabs add a LH coat hook.
- COLORS: Choice of five on reg. cabs and three on ext. cabs. See Color and Trim specifications for details.
- DOME LAMP: Switch in LH door jamb.
- DOOR PANELS: Grained molded plastic.
- DOOR SILL PLATE: Gray.
- FLOOR COVERING: Embossed black rubber mat.
- GAGES: Including speedometer, odometer, fuel level, voltmeter, temperature, oil pressure and additional telltale lights.

- GLOVE BOX: Latched door and beverage holder.
- HEADLINER: Vinyl with matching retainer moldings.
- HEATER: Deluxe with windshield and side window defoggers.
- INSULATION: Provided on dash panel, cowl top and sides, and doors. Ext. cabs have additional insulation on the rear quarter and back panels and on floor coverings. Extra insulation is provided with diesel engines.
- MIRROR: 10-inch rearview.
- RADIO: Manually-tuned AM radio with two 4" x 6" standard front dash speakers and a fixed mast antenna. (Refer to

- the Delco Electronics brochure in RPO Detail for further information).
- SEATS: 3-passenger all-vinyl trim front bench with folding backrest.
- STEERING WHEEL: Custom urethane 4-spoke.
- SUNSHADES: Color-keyed vinyl RH and LH padded.
- TOOLS: Mechanical jack and wheel wrench located behind front seat or on rear compartment floor.
- TRIM PANELS: Ext. cabs have rear upper, lower and side trim panels and a molded color-keyed cloth headliner with matching retaining moldings.
- WINDOWS: Tinted glass.

SCOTTSDALE

(Z62)

The Scottsdale trim level is an optional trim level for the C/K series. It is designed to offer truck buyers an increased level of comfort and convenience features compared to the standard Cheyenne trim level.

The following features are standard. Bold type denotes equipment in addition to or replacing that of the Cheyenne trim level.

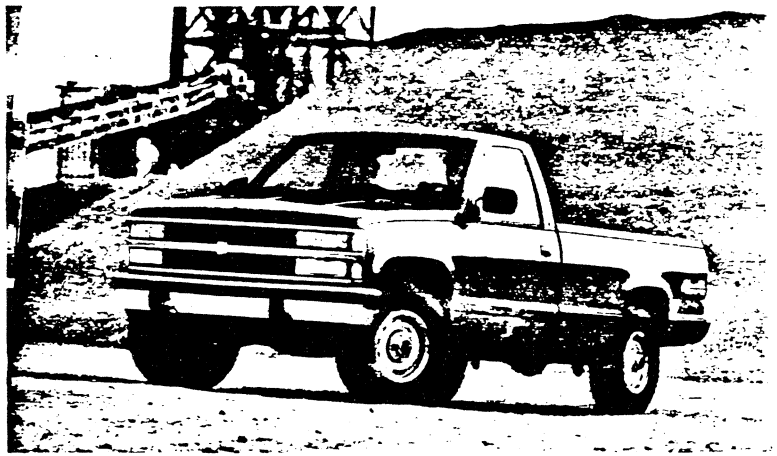

Some equipment shown may be optional or extra cost.

POWERTRAIN/CHASSIS

- ALTERNATOR: 85 Amp Delcotron.
- BATTERY: Gas engines—12 volt, neg. ground; 630 CCA @ 0 degrees F. Diesel engines—Two 12 volt, neg. ground; 570 CCA @ 0 degrees F.
- BRAKES: Power; vacuum. Front—disc. Rear—drum. (except C/K3500) Includes rear wheel anti-lock. C/K3500—Power; hydraulic. Front—disc. Rear—drum. Includes rear wheel anti-lock braking system.
- ENGINE: 4.3-liter V6 EFI on C/K1500 and 7200-lb. GVWR C/K2500. 160 net HP @ 4000 rpm and 235 lb. ft. of net torque @ 2400 rpm. Heavy-Duty 4.3-liter V6 EFI on C/K2500 at 8600-lb. GVWR. 150 net HP @ 4000 rpm and 230 lb. ft. of net torque @ 2400 rpm. 6.2-liter V8 diesel with mechanical fuel

- injection is available with B3J diesel equip. 5.7-liter V8 EFI on C/K3500. 190 net HP @ 4000 rpm and 300 lb. ft. of net torque @ 2400 rpm. (See Powertrains for details.)
- EXHAUST: Single.
- FRAME: All-welded ladder-type, channel design and boxed front-end section.
- FUEL TANK: 25.0-gallon (approx.) on C/K10703, C/K10753 and C/K20753. 34.0-gallon (approx.) on C/K10903, C/K10953, C/K20903, C/K20953 and C/K3500.
- REAR AXLE: Hypoid, Semi-Floating on C/K1500, and C/K2500. Hypoid, Full-Floating on C/K3500. Standard axle ratios vary.
- SHOCK ABSORBERS:—25 mm piston dia. front and rear on C/K1500. —32 mm piston dia. front on C/K2500 at

- 7200 lbs. GVWR and C/K3500. Also, rear on C/K2500 and C/K3500. —35 mm piston dia. front on C/K2500 at 8600 lbs. GVWR.
- STABILIZER BAR: Front—1.25 inch diameter on 2-wheel drive models and 1.18 inch diameter on 4-wheel drive models.
- STEERING: Integral Power. Ratio—16/13:1.
- SUSPENSION: Front—Independent with computer-selected springs. Two-wheel drives with coil springs; four-wheel drives with torsion bars. Rear—Multi-Leaf springs; Semi-Elliptic two-stage on all models except C/K3500. Combined Semi-Elliptic two-stage Main/Auxiliary on C/K3500.
- TOW HOOKS: Two front on 4-wheel drives.
- TRANSMISSION: Manual (4-speed or 5-speed depending on model).

EXTERIOR

- AIR DAM: Black. (Not included on models at or above 8600 lbs. GVWR).
- BUMPER: Chrome front with **black strip**.
- COLORS: Choice of ten in a solid paint scheme. See Color and Trim specifications for details.
- GRILLE: **Deluxe dark argent grille with bright trim**.
- HEADLAMPS: **Composite halogen**.
- HORN: **Dual low- and high-note**.
- MOLDINGS: **Black body side and wheel**

- opening (except K2500 C6P, K3500, and Sportside models.)**
- MIRRORS: Black RH and LH below-eye-line type with adjustable heads. Head size is 9.0" x 6.5".
- NAMEPLATE: **Scottsdale**.
- PICKUP BOX: All-welded double wall construction and extensive corrosion protection throughout.
- SPARE TIRE/WHEEL: Full-size on C/K1500 only. Optional on C/K2500 and C/K3500.

- SPARE TIRE CARRIER: Winch-type mounted under frame at rear (C/K1500 only.)
- TIRES: Four steel-belted radial tires. (Tire size varies with model. See Wheels and Tires for details.)
- WHEELS: **Rally (except dual rear-wheel models.)** (Wheel size varies with model. See Wheels and Tires for details.)
- WHEEL OPENING FLARES: Black on K2500 C6P and K3500 models. (Dual rear-wheel models have front flares only).

INTERIOR

- ARMREST: RH and LH padded; integral with door panels.
- CIGARETTE LIGHTER.
- COAT HOOKS: **RH and LH coat hooks**.
- COLORS: Choice of five on reg. cabs and three on ext. cabs. See Color and Trim specifications for details.
- DOME LAMP: Switches in LH and RH door jambs.
- DOOR PANELS: **Color-keyed** grained molded plastic with **soft vinyl trim, map pocket and Scottsdale emblems**.
- DOOR PILLAR AND ROOF SIDE PANELS: **Color-keyed**.
- DOOR SILL PLATE: **Color-keyed**.
- FLOOR COVERING: **Color-keyed** embossed rubber mat.
- GAGES: Including speedometer, odometer,

- fuel level, voltmeter, temperature, oil pressure and additional telltale lights.
- GLOVE BOX: Latched door and beverage holder.
- HEADLINER: **Color-keyed cloth. Reg. cab and ext. cabs include matching retainer moldings**.
- HEATER: **Deluxe** with windshield and side window defoggers.
- INSULATION: Provided on dash panel, cowl top and sides, and doors. Ext. cabs have additional insulation on the rear quarter and back panels and on floor coverings, **plus insulation on headliners**. Extra insulation is provided with diesel engines.
- MIRROR: 10-inch rearview.
- RADIO: Manually-tuned AM radio with two 4" x 6" standard front dash speakers and a

- fixed mast antenna. (Refer to the Delco Electronics brochure in RPO Detail for further information).
- STORAGE TRAY: **Full width behind seat on floor**.
- SEATS: 3-passenger **standard cloth trim** front bench with folding backrest.
- STEERING WHEEL: Custom urethane 4-spoke.
- SUNSHADES: **Color-keyed vinyl** RH and LH padded.
- TOOLS: Mechanical jack and wheel wrench located behind front seat or on rear compartment floor.
- TRIM PANELS: Ext. cabs have cab rear upper, lower and side trim panels.
- WINDOWS: Tinted glass.
- WINDSHIELD WIPERS: Intermittent.

SILVERADO

(YE9)

The Silverado trim level is an optional trim level for the C/K series. It is designed to offer truck buyers an increased level of comfort and convenience features compared to the standard Cheyenne and the optional Scottsdale trim levels.

The following features are standard. Bold type denotes equipment in addition to or replacing that of the Scottsdale trim level.



Some equipment shown may be optional or extra cost.

POWERTRAIN/CHASSIS

- ALTERNATOR: 85 Amp Delcotron.
- BATTERY: Gas engines—12 volt, neg. ground; 630 CCA @ 0 degrees F. Diesel engines—Two 12 volt, neg. ground; 570 CCA @ 0 degrees F.
- BRAKES: Power; vacuum. Front—disc. Rear—drum. (except C/K3500). Includes rear wheel anti-lock. Power; hydraulic. Front—disc. Rear—drum. (C/K3500 series only). Includes rear wheel anti-lock braking system.
- ENGINE: 4.3-liter V6 EFI on C/K1500 and 7200-lb. GVWR C/K2500. 160 net HP @ 4000 rpm and 235 lb. ft. of net torque @ 2400 rpm. Heavy-Duty 4.3-liter V6 EFI on C/K2500 8600-lb. GVWR. 150 net HP @ 4000 rpm and 230 lb. ft. of net torque @ 2400 rpm. 6.2-liter V8 diesel with mechanical fuel injection is available with B3J diesel equip. (see Powertrains for details).

- 5.7-liter V8 EFI on C/K3500. 190 net HP @ 4000 rpm and 300 lb. ft. of net torque @ 2400 rpm.
- EXHAUST: Single.
- FRAME: All-welded ladder-type, channel design and boxed front-end section.
- FUEL TANK: 25.0-gallon (approx.) on C/K10703, and C/K10753 and C/K20753. 34.0-gallon (approx.) on C/K10903, C/K10953, C/K20903, C/K20953 and C/K3500.
- REAR AXLE: Hypoid, Semi-Floating on C/K1500, and 2500. Standard axle ratio varies. Hypoid, Full-Floating on C/K3500 series. Standard axle ratios vary.
- SHOCK ABSORBERS: —25 mm piston dia. front and rear on C/K1500. —32 mm piston dia. front on C/K2500 at 7200 lbs. GVWR and C/K3500. Also, rear on C/K2500 and 3500.

- 35 mm piston diameter front on C/K2500 at 8600 lbs. GVWR.
- STABILIZER BAR: Front—1.25 inch diameter on 2-wheel drive models and 1.18 inch diameter on 4-wheel drive models
- STEERING: Integral Power. Ratio—16/13:1.
- SUSPENSION: Front—Independent with computer-selected springs. Two-wheel drive models with coil springs; four-wheel drive models with torsion bars. Rear—Multi-Leaf springs; Semi-Elliptic two-stage on C/K models except C/K3500. Combined Semi-Elliptic two-stage Main/Auxiliary on C/K3500.
- TOW HOOKS: Two front on 4-wheel drives.
- TRANSMISSION: Manual (4-speed or 5-speed depending on model. See Powertrains section for details).

EXTERIOR

- AIR DAM: Black. (Not included on model at or above 8600 lbs. GVWR).
- BUMPER: Chromed front with black strip and bright trim.
- COLORS: Choice of ten in a solid paint scheme. See Color and Trim specifications for details.
- GRILLE: Deluxe dark argent grille with bright trim.
- HEADLAMPS: Composite halogen.
- HORN: Dual low- and high-note.
- INSULATION: Hood and cab-to-fender.

- MOLDINGS: Black body side with bright trim and bright wheel opening (except K2500 C6P, K3500, and Sportside models.)
- MIRRORS: Black RH and LH below-eye-line type with adjustable heads. Head size is 9.0" x 6.5".
- NAMEPLATES: **Silverado.**
- PICKUP BOX: All-welded double wall construction and extensive corrosion protection throughout.
- SPARE TIRE/WHEEL: Full-size on C/K1500 only. (Optional on C/K2500 and 3500).

- SPARE TIRE CARRIER: Winch-type mounted under frame at rear. (C/K1500 only).
- TIRES: Four steel-belted radials. Tire size varies with model. (See Wheels and Tires for details).
- WHEELS: Rally (except dual rear-wheel models.) (Wheel size varies with model. See Wheels and Tires for details).
- WHEEL OPENING FLARES: Black on K2500 C6P and K3500. (Dual rear-wheel models have front flares only).
- WINDOWS: Swing-out rear quarter windows on ext. cabs.

INTERIOR

- ARMREST: RH and LH padded; integral with door panels.
- CAB BACK PANELS: Color-keyed carpet.
- CIGARETTE LIGHTER.
- COAT HOOKS: RH and LH.
- COLORS: Choice of five on reg. cabs and three on ext. cabs. See Color and Trim specifications for details.
- DOME LAMP: Switches in LH and RH door jams.
- DOOR PANELS: Two-toned soft vinyl over plastic trim and includes map pocket, door closing assist straps and Silverado emblems.
- DOOR PILLAR AND ROOF SIDE PANELS: Color-keyed.
- DOOR SILL PLATE: Color-keyed.
- FLOOR COVERING: Color-keyed carpeting.
- FLOOR MATS: Front and rear removable color-keyed (front only on regular cab.)
- GAGES: Including speedometer, odometer, fuel level, voltmeter, temperature, oil pressure and additional telltale lights.

- GLOVE BOX: Latched door and beverage holder.
- HEADLINER: Color-keyed cloth. Reg. and ext. cabs include matching retainer moldings.
- HEATER: Deluxe with windshield and side window defoggers.
- INSULATION: Provided on the dash panel, cowl top and sides, and doors. Ext. cabs have additional insulation on the rear quarter and back panels and on floor coverings, plus insulation on headliners and on reg. cab back panels. In addition, diesel engines are provided with extra insulation.
- MIRROR: 10-inch rearview mirror.
- RADIO: Electronically-tuned AM/FM stereo radio with seek-scan and digital clock. Includes two 4" x 6" front dash standard speakers and two 4" x 6" rear extended range speakers located to the rear above the door. (Refer to the Delco Electronics brochure in RPO Detail for further information).

- SEATS: 3-passenger front bench with choice of Custom Vinyl or Custom Cloth with folding backrest. (Ext. cabs offer a choice of Custom Vinyl or Custom Cloth split front bench seat with RH easy-entry feature).
- STEERING WHEEL: Sport urethane 4-spoke.
- STORAGE TRAY: Full width behind seat on floor.
- SUNSHADES: Color-keyed RH and LH padded with cloth covering, storage strap on LH unit and visor mirror on RH unit.
- TOOLS: Mechanical jack and wheel wrench located behind front seat or on rear compartment floor.
- TRIM PANELS: Ext. cabs have cab rear upper, lower and side trim panels.
- WINDOWS: Tinted glass.
- WINDSHIELD WIPERS: Intermittent.

454 SS (B4U)

The 454 SS is a 2-wheel drive sport truck package aimed specifically at the performance-minded buyer. It begins with Silverado trim and adds special performance equipment and features to create a unique-to-Chevrolet sport truck.

The following features are standard. Bold type denotes equipment in addition to or replacing that of the Silverado trim level.

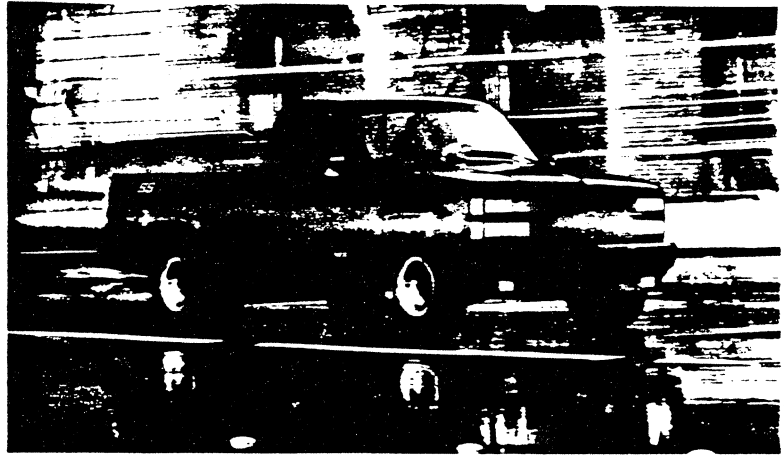

Some equipment shown may be optional or extra cost.

POWERTRAIN/CHASSIS

- ALTERNATOR: **100 amp Delcotron.**
- BATTERY: 12 volt, neg. ground; 630 CCA @ 0 degrees F.
- BRAKES: Power; vacuum. Front—disc. Rear—drum. Includes rear wheel anti-lock braking system.
- ENGINES: **7.4-liter V8 EFI. 230 net hp @ 3600 rpm and 385 lb. ft. of net torque @ 1600 rpm.**
- EXHAUST: **Dual—Pipes.**
- FRAME: All-welded ladder-type, channel design and boxed front-end section.
- FUEL TANK: 25.0-gallon (approx.).
- REAR AXLE: Hypoid, Semi-Floating with a **4.10 axle ratio.**
- SHOCK ABSORBERS: **46 mm piston dia. front and rear.**
- STABILIZER BAR: Front—1.25 inch dia.
- STEERING: Integral Power. **Ratio—12.7:1.**
- SUSPENSION: Front—Independent with computer-selected springs. Two-wheel drives with coil springs. Rear—Multi-Leaf springs; Semi-Elliptic two-stage.
- TRANSMISSION: **Heavy-Duty 4-speed automatic with overdrive.**

EXTERIOR

- AIR DAM: **Black with fog lamps.**
- BUMPER: **Black front and rear with rub strips.**
- COLORS: **Onyx black** in a solid paint scheme.
- DECALS: **Sport identification.**
- EXTERIOR TRIM: **Blackout.**
- GRILLE: **Blackout.**
- HEADLAMPS: Composite halogen.
- HORN: Dual low- and high-note.
- MIRRORS: Black RH and LH fixed with adjustable heads. **Head size is 6.0" x 4.5".**
- MOLDINGS: Black body side.
- PICKUP BOX: All-welded **6.5-foot, double** wall construction and extensive corrosion protection throughout.
- SPARE TIRE/WHEEL: Full-size.
- SPARE TIRE CARRIER: Winch-type mounted under frame at rear.
- TIRES: Four **P275/60R15AS** steel-belted radials.
- WHEELS: **15.0" x 7.0" Chrome Styled.**

INTERIOR

- AIR CONDITIONING.
- AUXILIARY LIGHTING: Includes dome and reading, courtesy, ashtray, glove box, cargo area and underhood lamps.
- ARMREST: RH and LH padded; integral with door panels.
- CAB BACK PANELS: Color-keyed carpet and insulation.
- CIGARETTE LIGHTER.
- COAT HOOK: RH and LH.
- COLORS: **Garnet Custom Cloth.**
- COMFORTILT STEERING.
- DOME LAMP: Switches in LH and RH door jambs.
- DOOR PANELS: Two-toned soft vinyl over plastic trim and includes map pocket, door closing assist straps, and Silverado emblems.
- DOOR PILLAR AND ROOF SIDE PANELS: Color-keyed.
- DOOR SILL PLATE: Color-keyed.
- ELECTRONIC SPEED CONTROL.
- FLOOR COVERING: Color-keyed carpeting.
- FLOOR MATS: Front removable color-keyed.
- GAGES: Including speedometer, odometer, fuel level, **tachometer**, fuel level, voltmeter, temperature, oil pressure and additional telltale lights.
- GLOVE BOX: Latched door and beverage holder.
- HEADLINER: Color-keyed cloth. Includes matching retainer moldings.
- HEATER: Deluxe with windshield and side window defoggers.
- INSULATION: Provided on dash panel, cowl top and sides, doors, headliners, and on back panels.
- POWER DOOR LOCKS.
- POWER WINDOWS.
- RADIO: Electronically-tuned AM /FM stereo radio with seek-scan, **stereo cassette tape with search and repeat, graphic** equalizer and digital clock. Includes four 4" x 6" extended range speakers—two located in the front dash and two located in the rear above the door. (Refer to the Delco Electronics brochure in RPO Detail for further information).
- SEATS: **Reclining, high-back bucket seats with console.** In Garnet Custom Cloth only.
- STEERING WHEEL: Sport urethane 4-spoke.
- STORAGE TRAY: Full width behind seat on floor.
- SUNSHADES: Color-keyed RH and LH padded with cloth covering, storage strap on LH unit and visor mirror on RH unit.
- TOOLS: Mechanical jack and wheel wrench located behind front seat or on rear compartment floor.
- WINDOWS: Tinted glass. Includes **sliding rear.**
- WINDSHIELD WIPERS: Intermittent.

KEY: S Standard O Optional Red Print Not Available w/California Emissions.
 — Not Offered H High Altitude Emissions only. Bold Print Not Available w/High Altitude Emissions.

MODEL	ENGINE	TRANSMISSION			AXLES					GVWR
		(MM4) MANUAL 4-SPEED	(MM5) MANUAL 5-SPEED	(MX0) AUTO 4-SPEED	ECONOMY		POWER			
					3.08	3.42	3.73	4.10	4.56	
TWO-WHEEL DRIVE MODELS										
C1500 REGULAR CAB SPORTSIDE CC10703/E62	4.3L V6 (LB4)	—	S	—	S	O	—	—	—	5600
		—	—	O	S	O ⁴	H ³	—	—	
	5.0L V8 (L03)	—	S	—	S	O	—	—	—	5600
		—	—	O ⁵	S	O	—	—	—	
C1500 REGULAR CAB FLEETSIDE CC10703/E63	5.7L V8 (L05)	—	S	—	S	O	—	—	—	5600
		—	—	O	S	O	O ²	—	—	
	7.4L V8 (L19) ¹³	—	—	S	—	—	—	S	—	5600
C1500 REGULAR CAB FLEETSIDE CC10903/E63	4.3L V6 (LB4)	O ¹⁰	—	—	S	O	—	—	—	5600/ 6100 ⁹
		—	S	—	S	O	—	—	—	
		—	—	O	S	O ⁴	H ²	—	—	
	5.0L V8 (L03)	—	S	—	S	O	—	—	—	5600/ 6100 ⁹
		—	—	O ⁵	S	O	—	—	—	
	5.7L V8 (L05)	O	—	—	S	O	—	—	—	5600/ 6100 ⁹
		—	S	—	S	O	—	—	—	
	—	—	O	S	O	O ²	—	—		
	6.2L V8 (LH6) DIESEL	S	—	—	S	O	—	—	—	6100
		—	—	O	S	O	H	—	—	
C1500 EXTENDED CAB FLEETSIDE CC10753/E63 CC10953/E63	4.3L V6 (LB4)	O	—	—	S	O ⁴	—	—	—	6200
		—	S	—	S	O	—	—	—	
		—	—	O	S	O ⁴	H ¹	—	—	
	5.0L V8 (L03)	—	S	—	S	O	—	—	—	6200
		—	—	O ⁵	S	O	—	—	—	
	5.7L V8 (L05)	O	—	—	S	O	—	—	—	6200
		—	S	—	S	O	—	—	—	
	—	—	O	S	O	O ¹	—	—		
	6.2L V8 (LH6) DIESEL	S	—	—	S	O	—	—	—	6200
		—	—	O	S	O	H	—	—	
C2500 REGULAR CAB FLEETSIDE CC20903/E63	4.3L V6 (LB4)	O	—	—	—	S	O ^{1,4}	—	—	7200
		—	S	—	—	S	O ^{1,4}	—	—	
		—	—	O	—	S	O ^{1,4}	O ¹	—	
		S	—	—	—	—	—	—	S ¹	8600 (C6P)
		—	—	O	—	—	—	—	S ¹	
	5.0L V8 (L03)	—	S	—	—	S	O	—	—	7200
		—	—	O ⁵	—	S	O ⁶	O ⁶	—	
	5.7L V8 (L05)	O	—	—	—	S	O ¹	—	—	7200
		—	S	—	—	S	O ¹	—	—	
		—	—	O	—	S	O ³	O ³	—	
		S	—	—	—	S	O ¹	O ¹	—	8600 (C6P)
		—	—	O	—	—	S ¹	O ¹	O ¹	
	7.4L V8 (L19)	S	—	—	—	S	O	O ¹	—	8600 (C6P)
		—	—	O	—	—	S	O ¹	—	
	6.2L V8 (LH6) DIESEL	S	—	—	—	S	O ²	H	—	7200
	—	—	—	O	—	S	O	—	—	
	6.2L V8 (LL4) DIESEL	S	—	—	—	S	O	—	—	8600 (C6P)
	—	—	—	O	—	S	O	O	—	
C2500 EXTENDED CAB FLEETSIDE CC20753/E63 CC20953/E63	4.3L V6 (LB4)	O	—	—	—	S	O ^{1,4}	—	—	7200
		—	S	—	—	S	O ^{1,4}	—	—	
		—	—	O	—	S	O ^{3,4}	O ³	—	
		S	—	—	—	—	—	—	S	8600 ⁸ (C6P)
		—	—	O ²	—	—	—	—	S	
	5.0L V8 (L03)	—	S	—	—	S	O	—	—	7200
		—	—	O ⁵	—	S	O ⁶	O ⁶	—	
	5.7L V8 (L05)	O	—	—	—	S	O ¹	—	—	7200
		—	S	—	—	S	O ¹	—	—	
		—	—	O	—	S	O ³	O ³	—	
	S	—	—	—	S	O	O	—	8600 ⁸ (C6P)	
	—	—	O ²	—	—	S	O	O		

¹Requires KC4 Engine Oil Cooler. ²Requires V02 H.D. Cooling. ³Requires KC4 and V02 Cooling. ⁴Standard with High Altitude Emissions. ⁵Standard with California Emissions. ⁶With C60 Air Req. KC4. ⁷Requires 7.50-16D Tires. ⁸Requires F44 H.D. Chassis. ⁹N/A with RPO VLA. ¹⁰N/A with LT265/75R16C Tires. ¹¹California Requires V02 Cooling. ¹²454SS Model only.

Y: S Standard O Optional Red Print Not Available w/California Emissions.
 — Not Offered H High Altitude Emissions only. Bold Print Not Available w/High Altitude Emissions.

MODEL	ENGINE	TRANSMISSION			AXLES					GVWR
		(MM4)	(MM5)	(MX0)	ECONOMY		POWER			
		MANUAL 4-SPEED	MANUAL 5-SPEED	AUTO 4-SPEED	3.08	3.42	3.73	4.10	4.56	
TWO-WHEEL DRIVE MODELS										
C2500 EXTENDED CAB FLEETSIDE CC20753/E63 CC20953/E63	7.4L V8 (L19)	S	—	—	—	S	O	O ¹	—	8600 (C6P)
	6.2L V8 (LH6) DIESEL	S	—	—	—	S	O ⁴	H	—	7200
	6.2L V8 (LL4) DIESEL	S	—	—	—	—	S	O	—	8600 ⁹ (C6P)
C3500 REGULAR CAB BIG DOOLEY CC30903/E63 (R05)	5.7L V8 (L05)	S	—	—	—	—	—	S ¹	O ¹	10,000
	7.4L V8 (L19)	S	—	—	—	—	S	O ¹	O ¹	10,000
	6.2L V8 (LL4) DIESEL	S	—	—	—	—	—	S	O ³	10,000
C3500 EXTENDED CAB BIG DOOLEY CC30953/E63 (R05)	5.7L V8 (L05)	S	—	—	—	—	—	S ¹	O ¹	10,000
	7.4L V8 (L19)	S	—	—	—	—	S ²	O ²	O ^{1,7}	10,000
	6.2L V8 (LL4) DIESEL	S	—	—	—	—	—	S ²	O ^{2,7}	10,000
FOUR-WHEEL DRIVE MODELS										
K1500 REGULAR CAB SPORTSIDE CK10703/E62	4.3L V6 (LB4)	O	—	—	—	S ¹¹	O ¹	—	—	5600/ 6100 ⁹
	5.0L V8 (L03)	—	S	—	—	S ¹¹	O ¹	—	—	5600/ 6100 ^{9,9}
	5.7L V8 (L05)	O	—	—	—	S	O ¹	—	—	5600/ 6100 ⁹
K1500 REGULAR CAB FLEETSIDE CK10703/E63	4.3L V6 (LB4)	O ¹⁰	—	—	—	S ¹¹	O ¹	—	—	5600/ 6100 ⁹
	5.0L V8 (L03)	—	S	—	—	S ¹¹	O ⁶	—	—	5600/ 6100 ⁹
	5.7L V8 (L05)	O	—	—	—	S	O ¹	—	—	5600/ 6100 ⁵
K1500 REGULAR CAB FLEETSIDE CK10903/E63	4.3L V6 (LB4)	O	—	—	—	S ¹¹	O ¹	—	—	6200/ 6600 ⁹
	5.0L V8 (L03)	—	S	—	—	S ¹¹	O ¹	H ^{1,8}	—	6200/ 6600 ⁹
	5.7L V8 (L05)	O	—	—	—	S	O ¹	—	—	6200/ 6600 ⁹
K1500 EXTENDED CAB FLEETSIDE CK10753/E63 CK10953/E63	4.3L V6 (LB4)	O	—	—	—	S ¹¹	O ¹	—	—	6600
	5.0L V8 (L03)	—	S	—	—	S ¹¹	O ¹	—	—	6600
	5.7L V8 (L05)	O	—	—	—	S	O ¹	—	—	6600
K2500 REGULAR CAB FLEETSIDE CK20903/E63	4.3L V6 (LB4)	O	—	—	—	S	O ¹	—	—	7200
	5.0L V8 (L03)	—	S	—	—	S	O	—	—	8600 (C6P)
	7.4L V8 (L19)	S	—	—	—	S	O	O ¹	—	8600 (C6P)

¹Requires KC4 Engine Oil Cooler.
²Requires V02 H.D. Cooling.
³Requires KC4 and V02 Cooling.
⁴Standard with High Altitude Emissions.

⁵Standard with California Emissions.
⁶With C60 Air Req. KC4.
⁷Requires 7.50-16D Tires.
⁸N/A C/K20753 Models.

⁹Requires F44 H.D. Chassis.
¹⁰N/A with RPO V1A.
¹¹N/A with LT265/75R16C Tires.

¹²California Requires V02 Cooling.
¹³454SS Model only.

KEY: S Standard O Optional Red Print Not Available w/California Emissions.
 — Not Offered H High Altitude Emissions only. Bold Print Not Available w/High Altitude Emissions.

MODEL	ENGINE	TRANSMISSION			AXLES					GVWR	
		(MM4) MANUAL 4-SPEED	(MM5) MANUAL 5-SPEED	(MX0) AUTO 4-SPEED	ECONOMY		POWER				
					3.08	3.42	3.73	4.10	4.56		
FOUR-WHEEL DRIVE MODELS											
K2500 REGULAR CAB FLEETSIDE CK20903/E63	5.7L V8 (L05)	O	—	—	—	S	O ¹	—	—	7200	
		—	S	—	—	S	O ¹	—	—		
		—	—	O	—	S	O ¹	O ¹	—		
	6.2L V8 (LH6) DIESEL	S	—	—	—	S	O ¹	O ¹	—	8600 (C6P)	
		—	—	O	—	S	O	—	—	7200	
		S	—	—	—	S	O	—	—	8600 (C6P)	
K2500 EXTENDED CAB FLEETSIDE CK20753/E63 ¹² CK20953/E63	4.3L V6 (LB4)	O	—	—	—	S	O ¹	—	—	7200	
		—	S	—	—	S	O ¹	—	—		
		—	—	O	—	S	O ^{1,4}	O ¹	—		
	5.0L V8 (L03)	—	—	O ⁵	—	S	O ⁶	O ⁶	—	8600 ⁸ (C6P)	
		—	S	—	—	S	O	—	—	7200	
		—	—	O ⁵	—	S	O ⁶	O ⁶	—		
5.7L V8 (L05)	O	—	—	—	S	O ¹	—	—	7200		
	—	S	—	—	S	O ¹	—	—			
	—	—	O	—	S	O ¹	O ¹	—			
7.4L V8 (L19)	—	—	O ²	—	—	S	O	O	8600 ⁸ (C6P)		
	S	—	—	—	S	O	O ¹	—	8600 (C6P)		
	—	—	O	—	—	S	O ¹	—			
6.2L V8 (LH6) DIESEL	S	—	—	—	S	O	—	—	7200		
	—	—	O	—	S	O	O	—			
	S	—	—	—	—	S	O	—	8600 ⁸ (C6P)		
6.2L V8 (LL4) DIESEL	—	—	O	—	—	S	O	O	8600 (C6P)		
	—	—	O	—	—	S	O	O			
	—	—	O	—	—	S	O	O			
K3500 REGULAR CAB BIG DOOLEY CK30903/E63 (R05)	5.7L V8 (L05)	S	—	—	—	—	—	S ¹	O ¹	10,000	
		—	—	O	—	—	—	S ³	O ¹		
		—	—	O	—	—	—	S	O ^{3,7}		
	7.4L V8 (L19)	S	—	—	—	—	—	S	O ¹	O ¹	10,000
		—	—	O	—	—	—	S	O ³	O ^{1,7}	
		—	—	O	—	—	—	S	O ⁷		
6.2L V8 (LL4) DIESEL	S	—	—	—	—	—	—	S	O	10,000	
	—	—	O	—	—	—	—	S	O ⁷		
	—	—	O	—	—	—	—	S	O ⁷		
K3500 EXTENDED CAB BIG DOOLEY CK30953/E63 (R05)	5.7L V8 (L05)	S	—	—	—	—	—	S ¹	O ¹	10,000	
		—	—	O	—	—	—	S ³	O ¹		
		—	—	O	—	—	—	S	O ³		O ^{1,7}
	7.4L V8 (L19)	S	—	—	—	—	—	S	O ¹	O ¹	10,000
		—	—	O	—	—	—	S	O ³	O ^{1,7}	
		—	—	O	—	—	—	S	O ⁷		
6.2L V8 (LL4) DIESEL	S	—	—	—	—	—	—	S	O	10,000	
	—	—	O	—	—	—	—	S	O ⁷		
	—	—	O	—	—	—	—	S	O ⁷		

¹Requires KC4 Engine Oil Cooler.
²Requires V02 H.D. Cooling.
³Requires KC4 and V02 Cooling.
⁴Standard with High Altitude Emissions.

⁵Standard with California Emissions.
⁶With C60 Air Req. KC4.
⁷Requires 7.50-16D Tires.
⁸N/A C/K20753 Models.

⁹Requires F44 H.D. Chassis.
¹⁰N/A with RPO VLA.
¹¹N/A with LT265/75R16C Tires.

¹²California Requires V02 Cooling.
¹³454SS Model only.

HORSEPOWER AND TORQUE RATINGS

ENGINE	4.3L V6		5.0L V8	5.7L V8		7.4L V8		6.2L V8 DIESEL	
RPO CODE	LB4	LB4	L03	L05	L05	L19	L19	LH6	LL4
RESTRICTIONS	Below 8600 Lbs. GVWR	8600 Lbs. GVWR	Up to 7200 Lbs. GVWR	Below 8600 Lbs. GVWR	8,600-10,000 Lbs. GVWR	8,600-10,000 Lbs. GVWR	454 SS Only	GVWR Below 8600 Lbs. GVWR	8600-10,000 Lbs. GVWR
CHART REFERENCE CODE	A	B	C	D	E	F	G	H	I
SAE NET HORSEPOWER Horsepower @ RPM	160 @ 4000	155 @ 4000	175 @ 4000	210 @ 4000	190 @ 4000	230 @ 3600	255 @ 4000	140 @ 3600	150 @ 3500
SAE NET TORQUE Lb. Ft. @ RPM	235 @ 2400	230 @ 2400	270 @ 2400	300 @ 2800	300 @ 2400	385 @ 1600	405 @ 2400	255 @ 1900	280 @ 2000
FUEL SYSTEM	EFI	EFI	EFI	EFI	EFI	EFI	EFI	Gear Driven Mechanical Fuel Injection	Gear Driven Mechanical Fuel Injection
CLUTCH SIZE (in.)	11	11	11	12	12	12	12	12	12
STD. BATTERY (Cold Cranking Amps @ 0°F)	630	630	630	630	630	630	630	2 @ 570 Ea.	2 @ 570 Ea.

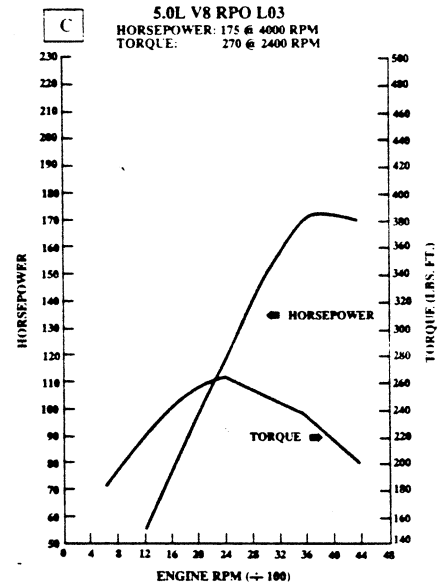
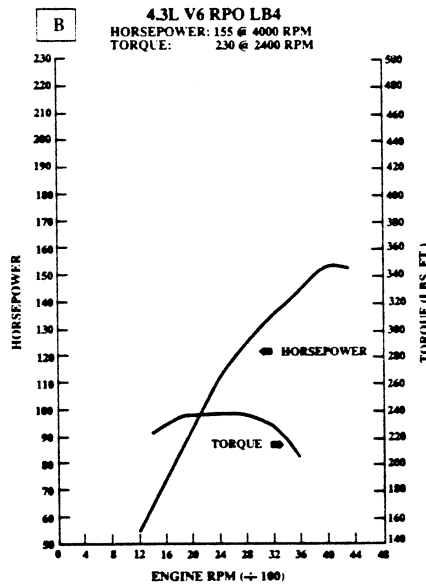
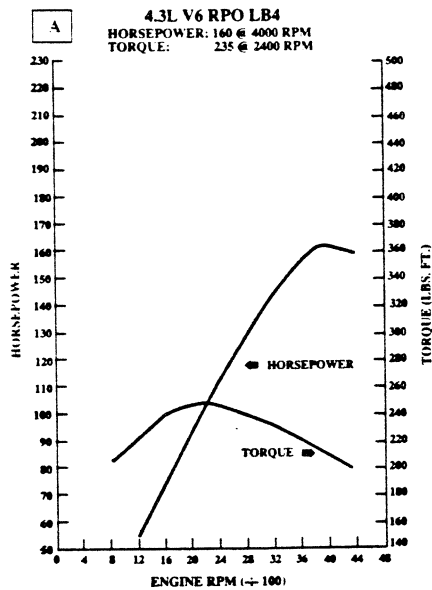

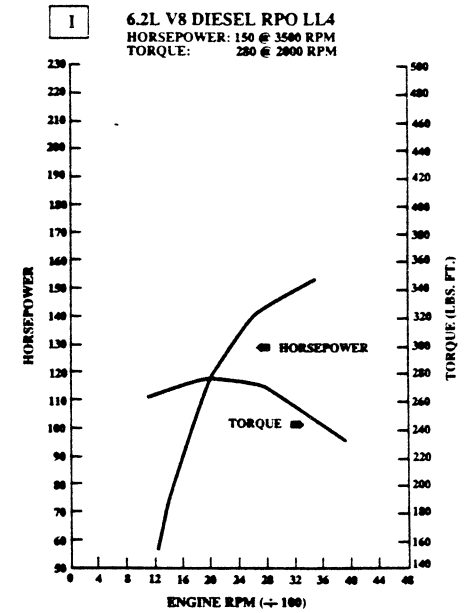
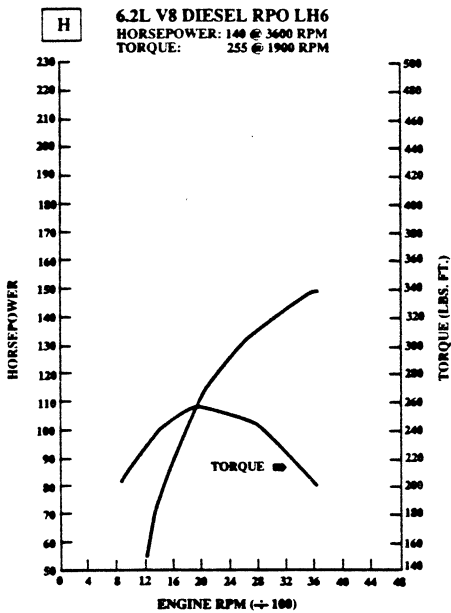
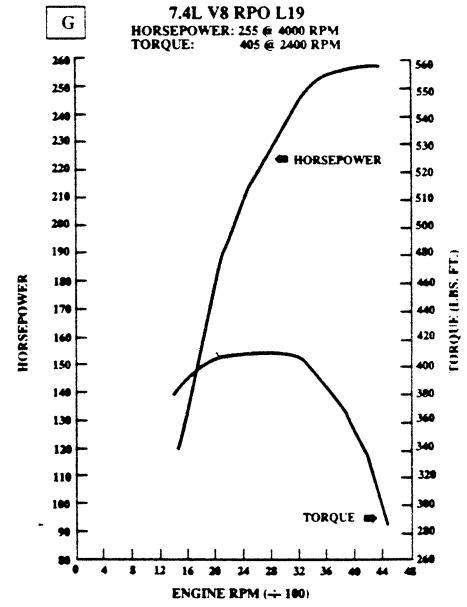
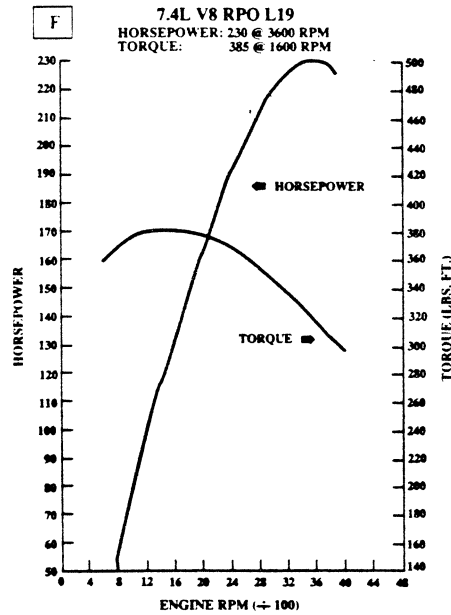
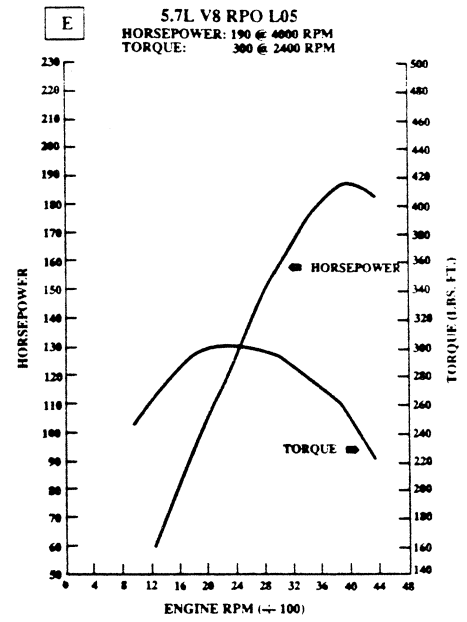
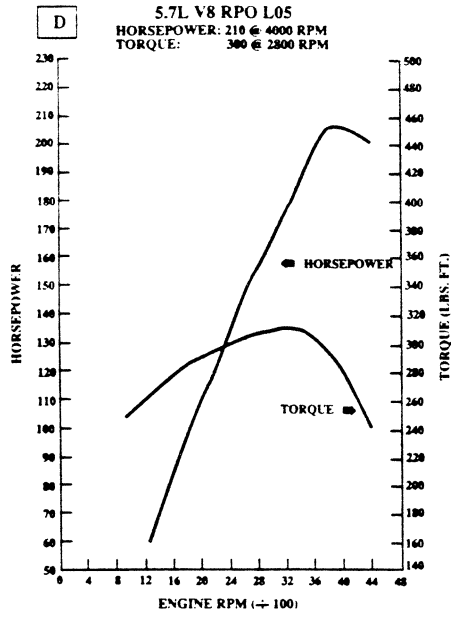

TRANSMISSION					
		MANUAL		AUTOMATIC	
TRANSMISSION MODEL	4-SPEED SM465	5-SPEED w/OVERDRIVE	HEAVY-DUTY w/OVERDRIVE NP4500 ¹	4-SPEED w/OVERDRIVE 4L80-E	4-SPEED w/OVERDRIVE 4L60
RPO CODE	MM4	MM5	MM5	MX0	MX0
SYNCHRONIZED SPEEDS	2/3/4	1/2/3/4/5	1/2/3/4/5	—	—
GEAR RATIOS					
First	6.55	4.02	6.34	2.48	3.06
Second	3.58	2.32	3.44	1.48	1.63
Third	1.70	1.40	1.71	1.00	1.00
Fourth	1.00	1.00	1.00	.75	.70
Fifth	—	.73	.73	—	—
Reverse	6.09	3.74	6.34	2.08	2.29
GEAR TYPE				Planetary	Planetary
Forward	Helical	Helical	Helical		
Reverse	Spur	Spur	Spur		
Center Distance (in.)	117	85	109		
TORQUE CONVERTER				Pump/Stator/ Turbine Automatic	Pump/Stator/ Turbine Automatic
Element Types	—	—	—		
Lock-up Clutch					
POWER TAKE-OFF					
Opening Type	SAE Std. 6-Bolt	—	SAE Std. 6-Bolt	—	—
Location	Both Sides ²		Both Sides ²		
Drive Gear	3rd Speed Counter Gear		3rd Speed Counter Gear		
PTO Gear RPM @1000 Engine RPM	425		425		
PTO Pitch Line Velocity @ 1000 Engine RPM	560ft./minute		560ft./minute		
LUBRICANT CAPACITY (pints)					
Oil	8	3.7	8.5	13.5	19
Refill	—	—	—	6	10

¹Interim availability only. Will replace the 4-speed manual, model SM 465 in certain applications. Please check your order guide for availability.

²Left hand side PTO not accessible on 4-wheel drive models.

TRANSFER CASE		
TRANSFER CASE MODEL	NEW PROCESS 241	BORG WARNER 1370
MODEL AVAILABILITY	K1500/2500	K3500
RATIOS: Hi Range Lo Range	1.00:1 2.72:1	100:1 2.69:1
LEVER POSITIONS	4-Lo (All-wheel Underdrive) N (Neutral) 2-Hi (Rear-wheel Drive) 4-Hi (All-wheel Drive)	4-Lo (All-wheel Underdrive) N (Neutral) 2-Hi (Rear-wheel Drive) 4-Hi (All-wheel Drive)
LEVER LOCATION	Rear of Transmission at Center of Floor	Rear of Transmission at Center of Floor
POWER TAKE-OFF DATA		
Opening Location	—	SAE Std. 6 Bolt Right Hand Side
OIL CAPACITY (pints)	4.6	3.1

REAR AXLES																				
AXLE MAKE AND CAPACITY (lbs.)	GM 3750					GM 4800			GM 6000				GM 6000 Full-Floating			GM 7500 Full-Floating				
PINION & RING GEAR Type	Hypoid					Hypoid			Hypoid				Hypoid			Hypoid				
	Ratio	2.73	3.08	3.42	3.73	4.10	3.42	3.73	4.10	3.42	3.73	4.10	4.56	3.42	3.73	4.10	3.42	3.73	4.10	4.56
	Pinion Teeth	15	13	12	11	10	12	11	10	12	11	10	9	12	11	10	12	11	10	9
	Ring Gear Teeth	41	41	41	41	41	41	41	41	41	41	41	41	41	41	41	41	41	41	41
	Ring Gear Dia. (in.)	8.5	8.5	8.5	8.5	8.5	9.5	9.5	9.5	9.5	9.5	9.5	9.5	10.5	10.5	10.5	10.5	10.5	10.5	10.5
DIFFERENTIAL Type Bearings, Type	2-Pinion Tapered Roller					2-Pinion Tapered Roller			2-Pinion Tapered Roller				4-Pinion Tapered Roller			4-Pinion Tapered Roller				
AXLE SHAFTS Type	Semi-Floating Integral Shaft and Drive Flange					Semi-Floating Integral Shaft and Drive Flange			Semi-Floating Integral Shaft and Drive Flange				Full-Floating Integral Shaft and Drive Flange			Full-Floating Integral Shaft and Drive Flange				
Min. Diameter (in.)	—					—			1.42				1.35			1.35				
HOUSING @ SPRING SEAT Section Diameter and Thickness (in.)	3.0 x .25					3.0 x .25			3.34 x .268				3.49 x .215 (C) 3.49 x .265 (K)			3.49 x .495				

FRONT AXLES										
AXLE MAKE AND CAPACITY (lbs.)	GM 3350-3925					GM 3750-4250				
PINION & RING GEAR Type	Hypoid					Hypoid				
	Ratio	3.42	3.73	4.10	3.42	3.73	4.10	4.56		
	Pinion Teeth	12	11	10	12	11	10	9		
	Ring Gear Teeth	41	41	41	41	41	41	41		
	Ring Gear Dia. (in.)	8.25	8.25	8.25	9.25	9.25	9.25	9.25		
DIFFERENTIAL Type Bearings, Type	2-Pinion Tapered Roller					2-Pinion Tapered Roller				
LUBRICANT CAPACITY (pints)	4.5					6				

TWO-WHEEL DRIVE MODELS

MODEL	C1500 REG. CAB SPORTSIDE/ FLEETSIDE	C1500 REG. CAB FLEETSIDE	C1500 EXT. CAB FLEETSIDE	C2500 REG. CAB FLEETSIDE	C2500 EXT. CAB FLEETSIDE	C3500 REG. CAB FLEETSIDE	C3500 EXT. CAB FLEETSIDE
MODEL NUMBER	CC10703/E62 CC10703/E63	CC10903/E63	CC10753/E63 CC10953/E63	CC20903/E63	CC20753/E63 CC20953/E63	CC30903/E63	CC30953/E63
		GAS B3J	GAS B3J	GAS B3J	GAS B3J	GAS B3J	GAS B3J

STANDARD SUSPENSION

PAYLOAD (Maximum lbs.)	1879	1899	1762	1741	2150	1612	3198		3039	2217	5055	5110	4757	4458
GVWR (lbs.)	5600		5600	6100	6200		7200		7200		10,000		10,000	
GAWR (lbs.) Front	2950		2950	3150	3500		3150	3400	3600		3600		3600	
Rear	3404		3404	3686	3686		4670 4670		7500		7500			
FRONT SUSPENSION Type	Independent Coil Spring		Independent Coil Spring		Independent Coil Spring		Independent Coil Spring		Independent Coil Spring		Independent Coil Spring		Independent Coil Spring	
Standard Spring Capacity Total (lbs.)	2950		2950	3200	3500		3150	3400	3600		3600		3600	
Front Shock Absorbers Piston Diameter (mm) Std/Opt	25/32 ²		25/32 ²		25/32 ²		32/—		32/—		32/—		32/—	
Front Stabilizer Bar Diameter (in.) Std/Opt	1.25		1.25		1.25		1.25		1.25		1.25		1.25	
REAR SUSPENSION Type	Semi-Elliptic 2-Stage Multi-Leaf Spring		Semi-Elliptic 2-Stage Multi-Leaf Spring		Semi-Elliptic 2-Stage Multi-Leaf Spring		Semi-Elliptic 2-Stage Multi-Leaf Spring		Semi-Elliptic 2-Stage Multi-Leaf Spring		Comb. Semi-Elliptic 2-Stage Main/Aux.		Comb. Semi-Elliptic 2-Stage Main/Aux.	
Standard Spring Cap. Total (lbs.)	3750		3750		3750		4800		4800		7500		7500	
Leaves Per Spring	4		4		4		5		5		6/1		6/1	
Leaf Thickness (in.)	2.14		2.14		2.14		2.71		2.71		4.86		4.86	
Rear Shock Absorber Piston Diameter (mm) Std/Opt	25/32 ²		25/32 ²		25/32 ²		32/—		32/—		32/—		32/—	
FRONT AXLE Type	—		—		—		—		—		—		—	
Make	—		—		—		—		—		—		—	
Maximum Capacity (lbs.)	2950		2950	3150	3600		3150	3400	3600		3800		3800	
Standard Hub Locks	—		—		—		—		—		—		—	
Pinion/Ring Gear Type	—		—		—		—		—		—		—	
REAR AXLE Type	Semi-Floating		Semi-Floating		Semi-Floating		Semi-Floating		Semi-Floating		Full-Floating		Full-Floating	
Make	GM		GM		GM		GM		GM		GM		GM	
Maximum Capacity (lbs.)	3750		3750		3750		4800		4800		7500		7500	
Pinion/Ring Gear Type	Hypoid		Hypoid		Hypoid		Hypoid		Hypoid		Hypoid		Hypoid	
STANDARD TIRES Front/Rear	Tubeless SBR P225/75R15 BW		Tubeless SBR P225/75 R15 BW R15 BW		Tubeless SBR P235/75R15 BW		Tubeless SBR LT225/75R16D BW		Tubeless SBR LT225/75R16D BW		Tubeless SBR LT225/75R16- C/D BW		Tubeless SBR LT225/75R16- C/D BW	
Tire Capacity (lbs.) each	1703		1703	1843	1843		2335		2335		1940/2150		1940/2150	
Inflation (psi) max.	35		35	35	35		65		65		50/55		55	
Revolutions per mile @ 45 mph	737		737	722	722		706		706		704/706		704/706	
WHEELS Size	15.0 x 6.0		15.0 x 6.0	15.0 x 7.0	15.0 x 7.0		16.0 x 6.5		16.0 x 6.5		16.0 x 6		16.0 x 6	
Capacity (lbs.) each	1702		1702	1843	1843		2400		2400		2400		2400	
Bolt Holes	5		5	5	5		6		6		8		8	
Bolt Circle Diameter (in.)	5		5	5	5		5.5		5.5		6.5		6.5	
Offset (mm)	0		0	13	13		13		13		127		127	

Based on Curb Weight. ² 46mm shocks with ZQ8 Sport Handling Package.

TWO-WHEEL-DRIVE MODELS													
MODEL	C1500 REG. CAB SPORTSIDE/ FLEETSIDE	C1500 REG. CAB FLEETSIDE	C1500 EXT. CAB FLEETSIDE	C2500 REG. CAB FLEETSIDE	C2500 EXT. CAB FLEETSIDE	C3500 REG. CAB FLEETSIDE	C3500 EXT. CAB FLEETSIDE						
MODEL NUMBER	CC10703/E62 CC10703/E63	CC10903/E63	CC10753/E63 CC10953/E63	CC20903/E63	CC20953/E63	CC30903/E63	CC30953/E63						
		GAS B3J	GAS B3J	GAS B3J	GAS B3J	GAS B3J	GAS B3J						
OPTIONAL SUSPENSION													
OPTION	—	F44	—	—	C6P	C6P	—	—					
PAYLOAD (Maximum lbs.) ¹	—	2250	—	—	4368 3617	4073 3413	—	—					
GVWR (lbs.)	—	6100	—	—	8600	8600	—	—					
GAWR (lbs.) Front	—	3150	—	—	3600	3600	—	—					
Rear	—	3686	—	—	6000	6000	—	—					
FRONT SUSPENSION Type	—	Ind. Coil Spring	—	—	Independent Coil Spring	Independent Coil Spring	—	—					
Spring Capacity Total (lbs.)	—	3150	—	—	3600	3600	—	—					
Front Shock Absorbers Piston Diameter (mm) Std/Opt	—	25/32 ²	—	—	35/—	35/—	—	—					
Front Stabilizer Bar Diameter (in.) Std/Opt	—	1.25	—	—	1.25	1.25	—	—					
REAR SUSPENSION Type	—	Semi-Ell. 2-Stage Multi- Leaf Spring	—	—	Semi-Elliptic 2-Stage Multi-Leaf Spring	Semi-Elliptic 2-Stage Multi-Leaf Spring	—	—					
Standard Spring Cap. Total (lbs.)	—	3750	—	—	6000	6000	—	—					
Leaves Per Spring	—	4	—	—	6	6	—	—					
Leaf Total Thickness (in.)	—	2.14	—	—	3.27	3.27	—	—					
Rear Shock Absorber Piston Diameter (mm) Std/Opt	—	25/32 ²	—	—	32/—	32/—	—	—					
FRONT AXLE Type	—	—	—	—	—	—	—	—					
Make	—	—	—	—	—	—	—	—					
Maximum Capacity (lbs.)	—	3150	—	—	3800	3800	—	—					
Standard Hub Locks	—	—	—	—	—	—	—	—					
Pinion/Ring Gear Type	—	—	—	—	—	—	—	—					
REAR AXLE Type	—	Semi- Floating	—	—	Semi-Floating	Semi-Floating	—	—					
Make	—	GM	—	—	GM	GM	—	—					
Maximum Capacity (lbs.)	—	3750	—	—	6000	6000	—	—					
Pinion/Ring Gear Type	—	Hypoid	—	—	Hypoid	Hypoid	—	—					
STANDARD TIRES Front/Rear	—	TbIs SBR P235/ 75R15 BW 1843	—	—	Tubeless SBR LT245/75R16E BW	Tubeless SBR LT245/75R16E BW	—	—					
Tire Capacity (lbs.) each Front/Rear	—	1843	—	—	3042	3042	—	—					
Inflation (psi) max.	—	35	—	—	80	80	—	—					
Revolutions per mile @ 45 mph	—	722	—	—	678	678	—	—					
WHEELS Size	—	15x7	—	—	16x6.5	16x6.5	—	—					
Capacity (lbs.) each	—	1843	—	—	3000	3000	—	—					
Bolt Holes	—	5	—	—	8	8	—	—					
Bolt Circle Diameter (in.)	—	5	—	—	6.5	6.5	—	—					
Offset (mm)	—	13	—	—	17	17	—	—					

¹ Based on Curb Weight. ² 46mm shocks with ZQ8 Sport Handling Package.

FOUR-WHEEL DRIVE MODELS

MODEL	K1500 REG. CAB SPORTSIDE/ FLEETSIDE	K1500 REG. CAB FLEETSIDE		K1500 EXT. CAB FLEETSIDE		K2500 REG. CAB FLEETSIDE		K2500 EXT. CAB FLEETSIDE		K3500 REG. CAB FLEETSIDE		K3500 EXT. CAB FLEETSIDE	
	MODEL NUMBER	CK10703/E62 CK10703/E63	CK10903/E63		CK10753/E63 CK10953/E63		CK20903/E63		CK20753/E63 CK20953/E63		CK30903/E63		CK30953/E63
		GAS	B3J	GAS	B3J	GAS	B3J	GAS	B3J	GAS	B3J	GAS	B3J

STANDARD SUSPENSION

PAYLOAD (Maximum lbs.) ¹	1459	1489	1336	1440	1750	1572	1615	1431	2848	2339	2719	2817	2511	1668	4684	4739	4347	4468
GVWR (lbs.)	5600		5600	6100	6200	6600	7200		7200		10,000		10,000					
GAWR (lbs.) Front Rear	3350 3400	3400 3600	3400 3750	3600 3750	3600 3750		3750 4670		3750 4410		3750 7500		3750 7500					
FRONT SUSPENSION Type Standard Spring Capacity Total (lbs.)	Independent Torsion Bar		Independent Torsion Bar		Independent Torsion Bar		Independent Torsion Bar		Independent Torsion Bar		Independent Torsion Bar		Independent Torsion Bar					
Front Shock Absorbers Piston Diameter (mm) Std/Opt	25/32 ²		25/32 ²		25/32 ²		32/—		32/—		32/—		32/—					
Front Stabilizer Bar Diameter (in.) Std/Opt	1.18		1.18		1.18		1.18		1.18		1.18		1.18					
REAR SUSPENSION Type	Semi-Elliptic 2-Stage Multi-Leaf Spring		Semi-Elliptic 2-Stage Multi-Leaf Spring		Semi-Elliptic 2-Stage Multi-Leaf Spring		Semi-Elliptic 2-Stage Multi-Leaf Spring		Semi-Elliptic 2-Stage Multi-Leaf Spring		Comb. Semi-Elliptic 2-Stage Main/Aux		Comb. Semi-Elliptic 2-Stage Main/Aux					
Standard Spring Cap. Total (lbs.) Leaves Per Spring Leaf Thickness (in.)	3750 4 2.14	3750 4 2.14	3750 4 2.14	3750 4 2.14	3750 4 2.14		4800 5 2.71		4800 5 2.71		7500 6/1 4.86		7500 6/1 4.86					
Rear Shock Absorber Piston Diameter (mm) Std/Opt	25/32 ²		25/32 ²		25/32 ²		32/—		32/—		32/—		32/—					
FRONT AXLE Type Make Maximum Capacity (lbs.) Standard Hub Locks Pinion/Ring Gear Type	Independent GM 3350 Insta-Trac Hypoid		Independent GM 3450 3925 Insta-Trac Hypoid		Independent GM 3925 Insta-Trac Hypoid		Independent GM 3925 Insta-Trac Hypoid		Independent GM 3925 Insta-Trac Hypoid		Independent GM 4250 Insta-Trac Hypoid		Independent GM 4250 Insta-Trac Hypoid					
REAR AXLE Type Make Maximum Capacity (lbs.) Pinion/Ring Gear Type	Semi- Floating GM 3750 Hypoid		Semi- Floating GM 3750 Hypoid		Semi- Floating GM 3750 4800 Hypoid		Semi- Floating GM 4800 Hypoid		Semi- Floating GM 4800 Hypoid		Full- Floating GM 7500 Hypoid		Full- Floating GM 7500 Hypoid					
STANDARD TIRES Front/Rear Tire Capacity (lbs.) each Front/Rear Inflation (psi) max. Revolutions per mile @ 45 mph	Tubeless SBR LT225/75R16C BW 1940 50 704		Tubeless SBR LT225/75R16C BW 1940 50 704 704		Tubeless SBR LT245/75R16C BW 2205 50 681		Tubeless SBR LT225/75R16D BW 2335 65 706		Tubeless SBR LT245/75R16D BW 2205 50 681		Tubeless SBR LT245/75R16D BW 2335 65 678		Tubeless SBR LT245/75R16D BW 2335 65 678					
WHEELS Size Capacity (lbs.) each Bolt Holes Bolt Circle Diameter (in.) Offset (mm)	16.0 x 6.5 1700 6 5.5 44		16.0 x 6.5 1700 2400 6 5.5 44 50		16.0 x 6.5 2400 6 5.5 50		16.0 x 6.5 2400 6 5.5 50		16.0 x 6.5 2400 6 5.5 50		16.0 x 6.0 2440 8 6.5 127		16.0 x 6.0 2440 8 6.5 127					

Based on Curb Weight. ² 46mm shocks on Z71 Off-Road Package.

FOUR-WHEEL DRIVE MODELS

MODEL	K1500 REG. CAB SPORTSIDE/ FLEETSIDE	K1500 REG. CAB FLEETSIDE	K1500 EXT. CAB FLEETSIDE	K2500 REG. CAB FLEETSIDE	K2500 EXT. CAB FLEETSIDE	K3500 REG. CAB FLEETSIDE	K3500 EXT. CAB FLEETSIDE
MODEL NUMBER	CK10703/E62 CK10703/E63	CK10903/E63	CK10753/E63 CK10953/E63	CK20903/E63	CK20953/E63	CK30903/E63	CK30953/E63
		GAS B3J	GAS B3J	GAS B3J	GAS B3J	GAS B3J	GAS B3J

OPTIONAL SUSPENSION

OPTION	F44		F44	—	F44	—	C6P		C6P	—	—	
PAYLOAD (Maximum lbs.) ¹	1935	1968	1819	—	1750 1615	—	4000	3739	3628	3739	—	—
GVWR (lbs.)	6100		6100	—	6600	—	8600		8600		—	—
GAWR (lbs.) Front Rear	3600 3750		3600 3750	—	3600 3750	—	3750 6000		3750 6000		—	—
FRONT SUSPENSION Type	Independent Torsion Bar		Ind. Torsion Bar	—	Ind. Torsion Bar	—	Independent Torsion Bar		Independent Torsion Bar		—	—
Standard Spring Capacity Total (lbs.)	3600		3600	—	3600	—	3750		3750		—	—
Front Shock Absorbers Piston Diameter (mm) Std/Opt	25/32 ²		25/32 ²	—	25/32 ²	—	35/—		35/—		—	—
Front Stabilizer Bar Diameter (in.) Std/Opt	1.18		1.18	—	1.18	—	1.18		1.18		—	—
REAR SUSPENSION Type	Semi-Elliptic 2-Stage Multi-Leaf Spring		Semi-Ell. 2-Stage Multi- Leaf Spring	—	Semi-Ell. 2-Stage Multi- Leaf Spring	—	Semi-Elliptic 2-Stage Multi-Leaf Spring		Semi-Elliptic 2-Stage Multi-Leaf Spring		—	—
Standard Spring Cap. Total (lbs.)	3750		3750	—	3750	—	6000		6000		—	—
Leaves Per Spring	4		4	—	4	—	6		6		—	—
Leaf Total Thickness (in.)	2.14		2.14	—	2.14	—	3.27		3.27		—	—
Rear Shock Absorber Piston Diameter (mm) Std/Opt	25/32 ²		25/32 ²	—	25/32 ²	—	32/—		32/—		—	—
FRONT AXLE Type Make Maximum Capacity (lbs.) Standard Hub Locks Pinion/Ring Gear Type	Independent GM 3925 Insta-Trac Hypoid		Indpt. GM 3925 Insta- Trac Hypoid	—	Indpt. GM 4800 Insta- Trac Hypoid	—	Independent GM 4250 Insta-Trac Hypoid		Independent GM 4250 Insta-Trac Hypoid		—	—
REAR AXLE Type Make Maximum Capacity (lbs.) Pinion/Ring Gear Type	Semi-Floating GM 3750 Hypoid		Semi- Floating GM 3750 Hypoid	—	Semi- Floating GM 3925 Hypoid	—	Semi-Floating ³ GM 6000 Hypoid		Semi-Floating ³ GM 6000 Hypoid		—	—
STANDARD TIRES Front/Rear Tire Capacity (lbs.) each Front/Rear Inflation (psi) max. Revolutions per mile @ 45 mph	Tubeless SBR LT225/75R16C BW 1940 50 704		Tbts. SBR LT225/ 75R16C BW 1940 50 704	—	Tbts. SBR LT245/ 75R16C BW 2205 45 681	—	Tubeless SBR LT245/75R16E BW 3042 80 678		Tubeless SBR LT245/75R16E BW 3042 80 678		—	—
WHEELS Size Capacity (lbs.) each Bolt Holes Bolt Circle Diameter (in.) Offset (mm)	16.0 x 6.5 2400 6 5.5 50		16.0 x 6.5 2400 6 5.5 50	—	16.0 x 6.5 2400 6 5.5 50	—	16.0 x 6.5 3000 8 6.5 17		16.0 x 6.5 3000 8 6.5 17		—	—

¹ Based on Curb Weight ² 46mm shocks on Z71 Off-Road Package. ³ Full-Floating rear axle w/7.4L engine.

— - Not Available
 AS - All-Season
 SBR - Steel-Belted Radial Ply
 BW - Blackwall
 WW - Whitewall
 WL - White Lettered
 HWY - Highway
 ON-OFF - On-Off Road
 WOL - White Outline Lettered

TIRE SIZE	TYPE	RPO	PLY	LOAD RANGE	TIRE CAPACITY (lbs. ea.)	INFLATION (psi) max.	WHEEL SIZE (in.)	WHEEL CAPACITY (lbs. ea.)	BOLT HOLES	BOLT CIRCLE dia. (in.)	OFFSET (mm)	REV.PER mile @ 45 mph
P225/75R15 Tubeless	AS/SBR/WL Front Rear Spare	XEV YEV ZEV	—	Std	1703	35	15.0 x 6.0	1702	5	5	0	737
P225/75R15 Tubeless	AS/SBR/BW Front Rear Spare	XET YET ZET	—	Std	1703	35	15.0 x 6.0	1702	5	5	0	737
P235/75R15 Tubeless	AS/SBR/BW Front Rear Spare	XFL YFL ZFL	—	Std	1843	35	15.0 x 6.0	1702	5	5	0	722
P235/75R15 Tubeless	AS/SBR/WW Front Reg. Cab w/5600 GVWR	XFM	—	Std	1843	35	15.0 x 6.0	1702	5	5	0	722
	w/6100 GVWR	XFM	—	Std	1843	35	15.0 x 7.0	1843	5	5	13	722
	C1500 Ext Cab	XFM	—	Std	1843	35	15.0 x 7.0	1843	5	5	13	722
	Rear Reg. Cab w/5600 GVWR	YFM	—	Std	1843	35	15.0 x 6.0	1702	5	5	0	722
	w/6100 GVWR	YFM	—	Std	1843	35	15.0 x 7.0	1843	5	5	13	722
	C1500 Ext Cab	YFM	—	Std	1843	35	15.0 x 7.0	1843	5	5	13	722
	Spare Reg. Cab w/5600 GVWR	ZFM	—	Std	1843	35	15.0 x 6.0	1702	5	5	0	722
	w/6100 GVWR	ZFM	—	Std	1843	35	15.0 x 7.0	1843	5	5	13	722
	C1500 Ext Cab	ZFM	—	Std	1843	35	15.0 x 7.0	1843	5	5	13	722
P235/75R15 Tubeless	AS/SBR/WL Front Reg. Cab w/5600 GVWR	XFN	—	Std	1843	35	15.0 x 6.0	1702	5	5	0	722
	w/6100 GVWR	XFN	—	Std	1843	35	15.0 x 7.0	1843	5	5	13	722
	C1500 Ext Cab	XFN	—	Std	1843	35	15.0 x 7.0	1843	5	5	13	722
	Rear Reg. Cab w/5600 GVWR	YFN	—	Std	1843	35	15.0 x 6.0	1702	5	5	0	722
	w/6100 GVWR	YFN	—	Std	1843	35	15.0 x 7.0	1843	5	5	13	722
	C1500 Ext Cab	YFN	—	Std	1843	35	15.0 x 7.0	1843	5	5	13	722
	Spare Reg. Cab w/5600 GVWR	ZFN	—	Std	1843	35	15.0 x 6.0	1702	5	5	0	722
	w/6100 GVWR	ZFN	—	Std	1843	35	15.0 x 7.0	1843	5	5	13	722
	C1500 Ext Cab	ZFN	—	Std	1843	35	15.0 x 7.0	1843	5	5	13	722
P275/60R15 Tubeless	AS/SBR/BW Front	XCN	—	Std	1953	35	15.0 x 7.0	1843	5	5	0	743
	Rear	YCN	—	Std	1953	35	15.0 x 7.0	1843	5	5	0	743
	Spare	ZCN	—	Std	1953	35	15.0 x 7.0	1843	5	5	0	743
LT225/75R16C Tubeless	AS/SBR/BL Front K1500 Series	XHE	6	C	1940	50	16.0 x 6.5	1700	6	5.5	44	704
	C3500 Series w/R05 w/o B3J	XHE	6	C	1940	55	16.0 x 6.0	2400	8	6.5	127	704
	C3500 Series w/R05 w/B3J	XHE	6	C	1940	55	16.0 x 6.0	2400	8	6.5	127	704
	Rear	YHE	6	C	1940	50	16.0 x 6.5	1700	6	5.5	127	704
LT225/75R16C Tubeless	ON-OFF SBR/BW Front Rear Spare	XHJ YHJ ZHJ	6	C	1940	50	16.0 x 6.5	1700	6	5.5	44	704

WHEELS AND TIRES

KEY: — - Not Available
 AS - All-Season
 SBR - Steel-Belted Radial Ply
 BW - Blackwall
 WW - Whitewall
 WL - White Lettered
 HWY - Highway
 ON-OFF - On-Off Road
 WOL - White Outline Lettered

TIRE SIZE	TYPE	RPO	PLY	LOAD RANGE	TIRE CAPACITY (lbs. ea.)	INFLATION (psi) max.	WHEEL SIZE (in.)	WHEEL CAPACITY (lbs. ea.)	BOLT HOLES	BOLT CIRCLE dia. (in.)	OFFSET (mm)	REV.PER mile @ 45 mph
LT225/75R16C Tubeless	ON-OFF SBR/WOL Front Rear Spare	XHN YHN ZHN	6	C	1940	50	16.0 x 6.5	1700	6	5.5	44	704
LT225/75R16D Tubeless	AS/SBR/BW Front	XHP	8	D	2335	65	16.0 x 6.5	2400	6	5.5	50	706
	C3500 w/R05 w/o B3J	XHP	8	D	2150	55	16.0 x 6.0	2440	8	6.5	127	706
	C3500 w/R05 w/ B3J	XHP	8	D	2150	55	16.0 x 6.0	2440	8	6.5	127	706
	Rear C3500 w/R05 w/o B3J	YHP	8	D	2335	65	16.0 x 6.5	2400	6	5.5	50	706
	C3500 w/R05 w/ B3J	YHP	8	D	2150	55	16.0 x 6.0	2440	8	6.5	127	706
	Spare C3500 w/R05	ZHP ZHP	8 8	D D	2335 2150	65 55	16.0 x 6.5 16.0 x 6.0	2400 2440	6 8	5.5 6.5	50 127	706 706
LT225/75R16D Tubeless	ON-OFF AS/SBR/BW Front											
	K2500 Reg. Cab	XHR	8	D	2335	65	16.0 x 6.5	2400	6	5.5	50	706
	K3500 w/o B3J	XHR	8	D	2335	65	16.0 x 6.5	3000	8	6.5	17	706
	K3500 w/B3J	XHR	8	D	2335	65	16.0 x 6.0	2440	8	6.5	127	706
	Rear C/K2500 Reg. Cab	YHR	8	D	2335	65	16.0 x 6.5	2400	6	5.5	50	706
	C/K3500 w/R05 w/o B3J C/K3500 w/R05 w/B3J	YHR YHR	8 8	D D	2335 2335	65 65	16.0 x 6.0 16.0 x 6.0	2440 2440	8 8	6.5 6.5	127 127	706 706
Spare K3500, C2500 Reg. Cab	ZHR	8	D	2335	65	16.0 x 6.5	2400	6	5.5	50	706	
	CK3500 w/o R05	ZHR	8	D	2335	65	16.0 x 6.0	2440	8	6.5	127	706
LT245/75R16C Tubeless	AS/SBR/BW Front Rear Spare	XBK YBK ZBK	6	C	2205	50	16.0 x 6.5	2400	6	5.5	50	681
LT245/75R16C Tubeless	ON-OFF SBR/BW Front Rear Spare	XBN YBN ZBN	6	C	2205	50	16.0 x 6.5	2400	6	5.5	50	681
LT245/75R16C Tubeless	ON-OFF SBR/WL Front Rear Spare	XBX YBX ZBX	6	C	2205	50	16.0 x 6.5	2400	6	5.5	50	681
LT245/75R16E	AS/SBR/BW Front Rear Spare	XHH YHH ZHH	10	E	3042	80	16.0 x 6.5	3000	8	6.5	17	678

K PICKUP

WHEELS AND TIRES

— Not Available
AS - All-Season
SBR - Steel-Belted Radial Ply

BW - Blackwall
WW - Whitewall
WL - White Lettered

HWY - Highway
ON-OFF - On-Off Road
WOL - White Outline Lettered

TIRE SIZE	TYPE	RPO	PLY	LOAD RANGE	TIRE CAPACITY (lbs.) ea.	INFLATION (psi) max.	WHEEL SIZE (in.)	WHEEL CAPACITY (lbs.) ea.	BOLT HOLES	BOLT CIRCLE dia. (in.)	OFFSET (mm)	REV.PER mile @ 45 mph
LT245/75R16E Tubeless	ON-OFF SBR/BW Front K2500 Reg. Cab w/o C6P K2500/3500 w/C6P	XGK	10	E	3042	80	16.0 x 6.5	2400	6	5.5	50	678
		XGK	10	E	3042	80	16.0 x 6.5	3000	8	6.5	17	678
	Rear K2500 Reg. Cab w/o C6P K2500/3500 w/C6P	YGK	10	E	3042	80	16.0 x 6.5	2400	6	5.5	50	678
		YGK	10	E	3042	80	16.0 x 6.5	3000	8	6.5	17	678
	Spare C/K2500 C/K3500	ZGK	10	E	3042	80	16.0 x 6.5	2400	6	5.5	50	678
		ZGK	10	E	3042	80	16.0 x 6.5	3000	8	6.5	17	678
LT265/75R16C Tubeless	ON-OFF SBR/BW Front Reg. Cab Ext. Cab	XGL	6	C	2470	50	16.0 x 6.5	1700	6	5.5	44	655
		XGL	6	C	2470	50	16.0 x 6.5	2400	6	5.5	50	655
	Rear Reg. Cab Ext. Cab	YGL	6	C	2470	50	16.0 x 6.5	1700	6	5.5	44	655
		YGL	6	C	2470	50	16.0 x 6.5	2400	6	5.5	50	655
	Spare Reg. Cab Ext. Cab	ZGL	6	C	2470	50	16.0 x 6.5	1700	6	5.5	44	655
		ZGL	6	C	2470	50	16.0 x 6.5	2400	6	5.5	50	655
LT265/75R16C Tubeless	ON-OFF SBR/WOL Front Reg. Cab Ext. Cab	XGM	6	C	2470	50	16.0 x 6.5	1700	6	5.5	44	655
		XGM	6	C	2470	50	16.0 x 6.5	2400	6	5.5	50	655
	Rear Reg. Cab Ext. Cab	YGM	6	C	2470	50	16.0 x 6.5	1700	6	5.5	44	655
		YGM	6	C	2470	50	16.0 x 6.5	2400	6	5.5	50	655
	Spare Reg. Cab Ext. Cab	ZGM	6	C	2470	50	16.0 x 6.5	1700	6	5.5	44	655
		ZGM	6	C	2470	50	16.0 x 6.5	2400	6	5.5	50	655
7.50-16D Tubeless	HWY Nylon BW Front w/o B3J w/B3J	XDE	8	D	2140	60	16.0 x 6.0	2440	8	6.5	127	652
		XDE	8	D	2140	60	16.0 x 6.0	2440	8	6.5	127	652
	Rear w/o B3J w/B3J	YDE	8	D	2140	60	16.0 x 6.0	2440	8	6.5	127	652
Spare	ZDE	8	D	2140	60	16.0 x 6.0	2440	8	6.5	127	652	
7.50-16D Tubeless	ON-OFF Nylon BW Front w/o B3J w/B3J	XDL	8	D	2140	60	16.0 x 6.0	2440	8	6.5	127	652
		XDL	8	D	2140	60	16.0 x 6.0	2440	8	6.5	127	652
	Rear w/o B3J w/B3J	YDL	8	D	2140	60	16.0 x 6.0	2440	8	6.5	127	652
Spare	ZDL	8	D	2140	60	16.0 x 6.0	2440	8	6.5	127	652	

OPTIONAL WHEELS

RPO	DESCRIPTION	WHEEL SIZE (in.)	CAPACITY (lbs.)	BOLT HOLES	BOLT CIRCLE dia. (in.)	OFFSET (mm)
—	Wheels—Chrome (Part of BYP 2-Wheel Drive Sport Equip. Pkg.)	15.0 x 7.0	1843	5	5.0	13
—	Wheels—Chrome (Part of B4U and ZQ8 w/BYP)	15.0 x 7.0	1843	5	5.0	0
—	Wheels—Styled Painted (Part of ZQ8)	15.0 x 7.0	1843	5	5.0	0
N90	Wheels—Aluminum, Cast (2-Wheel Drive)	15.0 x 7.0	1843	5	5.0	13
PF4	Wheels—Aluminum, Cast (4-Wheel Drive)	16.0 x 7.0	1702	6	5.5	44

TWO WHEEL DRIVE MODELS

MODEL	C1500 REG. CAB SPORTSIDE/ FLEETSIDE	C1500 REG. CAB FLEETSIDE	C1500 EXT. CAB FLEETSIDE	C2500 REG. CAB FLEETSIDE	C2500 EXT. CAB FLEETSIDE			C3500 REG. CAB FLEETSIDE	C3500 EXT. CAB FLEETSIDE
MODEL NUMBER	CC10703/E62 CC10703/E63	CC10903/E63	CC10753/E63 CC10953/E63	CC20903/E63	CC20753/ E63	CC20953/ E63	CC20953/ E63 C6P	CC30903/E63	CC30953/E63

FRAME

Side Rail Dimensions Width (in.)	2.28	2.28	2.28	2.28		2.28			2.28	2.28	
Depth (in.)	6.30	6.30	6.30	6.30	7.24	6.30	6.30	7.24	7.24	7.24	
Thickness (in.)	.130	.130	.165	.130	.213	.165	.165	.244	.213	.244	
Section Modulus Rails only (cu. in.)	2.66	2.66	3.37	2.26	5.26	3.37	3.37	6.06	5.26	6.06	
RBM of Frame (lb. in.)	95,760	95,760	121,320	95,760	189,360	121,320	121,320	218,160	189,360	218,160	
Width Over Rails Front (in.)	45.3	45.3	45.3	45.3		45.3			45.3	45.3	
Rear (in.)	36.7	36.7	36.7	36.7		36.7			36.7	36.7	
Overall Length of Rail (in.)	181.1	200.0	205.1	224.0	200.0	200.1	205.1	224.0	224.1	200.1	224.1

STEERING

Type	Variable Ratio Integral Power	Variable Ratio Integral Power	Variable Ratio Integral Power	Variable Ratio Integral Power	Variable Ratio Integral Power	Variable Ratio Integral Power	Variable Ratio Integral Power	Variable Ratio Integral Power	Variable Ratio Integral Power	Variable Ratio Integral Power	
Steering Ratio On Center/At Lock	16/13:1 ¹	16/13:1 ¹	16/13:1 ¹	16/13:1	16/13:1	16/13:1	16/13:1	16/13:1	16/13:1	16/13:1	
Turning Diameter Curb-To-Curb (ft.)	41.3	44.6	48.1	52.9	44.6	45.7	48.1	52.9	52.9	45.7	52.9
Wall-To-Wall (ft.)	43.2	46.5	50.0	54.8	46.5	47.5	50.1	54.8	54.8	47.5	54.8

BRAKES

GVWR (lbs.)	5600	5600	6100	6200	7200	8600	7200	8600	10,000	10,000
Type	Vac. Power	Vac. Power		Vac. Power	Vac. Power		Vac. Power		Hyd. Power	Hyd. Power
	Front Disc/Rear Drum w/Rear Wheel Anti-Lock Brake System	Front Disc/Rear Drum w/Rear Wheel Anti-Lock Brake System	Front Disc/Rear Drum w/Rear Wheel Anti-Lock Brake System	Front Disc/Rear Drum w/Rear Wheel Anti-Lock Brake System	Front Disc/Rear Drum w/Rear Wheel Anti-Lock Brake System	Front Disc/Rear Drum w/Rear Wheel Anti-Lock Brake System	Front Disc/Rear Drum w/Rear Wheel Anti-Lock Brake System	Front Disc/Rear Drum w/Rear Wheel Anti-Lock Brake System	Front Disc/Rear Drum w/Rear Wheel Anti-Lock Brake System	Front Disc/Rear Drum w/Rear Wheel Anti-Lock Brake System
Booster Diaphragm Diameter (in.)	9.5 Tandem	9.5 Tandem		9.5 Tandem	9.5 Tandem		9.5 Tandem		—	—
Front Rotor Size Diameter x Thickness (in.)	11.57 x 1.0	11.57 x 1.0	11.57 x 1.25	11.57 x 1.25	11.57 x 1.25	12.50 x 1.26	11.57 x 1.25	12.50 x 1.26	12.50 x 1.26	12.50 x 1.26
Front Facing Contact Per Axle (sq. in.)	34.8	34.8		34.8	34.8	38.0	34.8	38.0	38.0	38.0
Rear Drum Size Diameter x Width (in.)	10.0 x 2.25	10.0 x 2.25		10.0 x 2.25	11.15 x 2.75	13.0 x 2.5	11.15 x 2.75	13.0 x 2.5	13.0 x 3.5	13.0 x 3.5
Rear Facing Contact Per Axle (sq. in.)	84.88	84.88		84.88	115.84	116.73	115.84	116.73	166.04	166.04
Parking Brake Type	Cable To Rear Wheels	Cable To Rear Wheels		Cable To Rear Wheels	Cable To Rear Wheels	Cable To Rear Wheels	Cable To Rear Wheels		Cable To Rear Wheels	Cable To Rear Wheels

¹Z08 Sport Suspension has a 12.7:1 ratio.

FOUR-WHEEL DRIVE MODELS

MODEL	K1500 REG. CAB SPORTSIDE/ FLEETSIDE	K1500 REG. CAB FLEETSIDE	K1500 EXT. CAB FLEETSIDE	K2500 REG. CAB FLEETSIDE	K2500 EXT. CAB FLEETSIDE			K3500 REG. CAB FLEETSIDE	K3500 EXT. CAB FLEETSIDE	
MODEL NUMBER	CK10703/E62 CK10703/E63	CK10903/E63	CK10753/E63 CK10953/E63	CK20903/E63		CK20753/ E63	CK20953/ E63	CK20953/ E63 C6P	CK30903/E63	CK30953/E63

FRAME

Side Rail Dimensions Width (in.)	2.28	2.28	2.28	2.28		2.28			2.28	2.28	
Depth (in.)	7.48	7.48	7.48	7.48		7.48			7.48	7.48	
Thickness (in.)	.134	.134	.165	.134	.213	.165	.165	.244	.213	.244	
Section Modulus Rails only (cu. in.)	3.27	3.27	4.06	3.27	5.25	4.06	4.06	6.06	5.25	6.06	
RBM of Frame (lb. in.)	117,720	117,720	146,160	117,720	189,000	146,160	146,160	218,160	189,000	218,160	
Width Over Rails Front (in.)	45.3	45.3	45.3	45.3		45.3			45.3	45.3	
Rear (in.)	36.7	36.7	36.7	36.7		36.7			36.7	36.7	
Overall Length of Rail (in.)	180.8	199.7	204.8	223.7	199.7	201.0	204.8	223.7	225.1	201.1	225.1

STEERING

Type	Variable Ratio Integral Power		Variable Ratio Integral Power		Variable Ratio Integral Power		Variable Ratio Integral Power		Variable Ratio Integral Power		Variable Ratio Integral Power		
Steering Ratio On Center/At Lock	16/13:1		16/13:1		16/13:1		16/13:1	16/13:1	16/13:1	16/13:1		16/13:1	
Turning Diameter Curb-To-Curb (ft.)	40.3		44.4		47.9	52.2	44.4	45.1	47.9	52.2	52.2	45.1	52.2
Wall-To-Wall (ft.)	42.3		46.3		49.8	53.7	46.3	46.7	49.8	53.7	53.7	46.7	53.7

BRAKES

GVWR (lbs.)	5600	6100	5600	6100	6200	6600	7200	8600	7200	8600	10,000	10,000
Type	Vac. Power		Vac. Power		Vac. Power		Vac. Power		Vac. Power		Hyd. Power	Hyd. Power
	Front Disc/Rear Drum w/Rear Wheel Anti-Lock Brake System		Front Disc/Rear Drum w/Rear Wheel Anti-Lock Brake System		Front Disc/Rear Drum w/Rear Wheel Anti-Lock Brake System		Front Disc/Rear Drum w/Rear Wheel Anti-Lock Brake System		Front Disc/Rear Drum w/Rear Wheel Anti-Lock Brake System		Front Disc/Rear Drum w/Rear Wheel Anti-Lock Brake System	Front Disc/Rear Drum w/Rear Wheel Anti-Lock Brake System
Booster Diaphragm Diameter (in.)	9.5 Tandem		9.5 Tandem		9.5 Tandem		9.5 Tandem		9.5 Tandem		—	—
Front Rotor Size Diameter x Thickness (in.)	11.57 x 1.0	11.57 x 1.25	11.57 x 1.0	11.57 x 1.25	11.57 x 1.25		11.57 x 1.20	12.50 x 1.26	11.57 x 1.25	12.50 x 1.26	12.50 x 1.26	
Front Facing Contact Per Axle (sq. in.)	42.24		42.24		42.24		42.24	42.24	42.24	42.24	42.24	
Rear Drum Size Diameter x Width (in.)	10.0 x 2.25		10.0 x 2.25		10.0 x 2.25	11.15 x 2.75	11.15 x 2.75	13.0 x 2.5	11.15 x 2.75	13.0 x 2.5	13.0 x 3.5	
Rear Facing Contact Per Axle (sq. in.)	84.88		84.88		115.84		115.84	116.73	115.84	116.73	166.04	
Parking Brake Type	Cable To Rear Wheels		Cable To Rear Wheels		Cable To Rear Wheels		Cable To Rear Wheels		Cable To Rear Wheels		Cable To Rear Wheels	

TWO WHEEL DRIVE AND FOUR WHEEL DRIVE MODELS

MODEL	C/K1500 REG. CAB SPORTSIDE/ FLEETSIDE	C/K1500 REG. CAB FLEETSIDE	C/K1500 EXTENDED CAB FLEETSIDE	C/K2500 REGULAR/EXTENDED CAB FLEETSIDE	C/K3500 REGULAR CAB FLEETSIDE	C/K3500 EXTENDED CAB FLEETSIDE
MODEL NUMBER	C/K10703/E62 C/K10703/E63	C/K10903/E63	C/K10753/E63 C/K10953/E63	C/K20903/E63-C/K20753/E63 C/K20953/E63	C/K30903/E63	C/K30953 E63

ELECTRICAL

ENGINE Std/Opt	4.3L V6/ 5.7L V8	5.0L V8	4.3L V6/ 5.7L V8	5.0L V8	6.2L V8	4.3L V6/ 5.7L V8	5.0L V8	6.2L V8	4.3L V6/ 5.7L V8	5.0L V8	6.2L V8	7.4L V8	7.4L V8	5.7L V8	6.2L V8	7.4L V8	5.7L V8	6.2L V8
STANDARD BATTERY Cold Cranking Amps @ 0° F @ -20° F Reserve Capacity Minutes @ 80° F	630 470	630 470	630 470	630 470	Two at 570 425	630 470	630 470	Two at 570 425	630 470	630 470	Two at 570 425	630 470	630 470	630 470	Two at 570 425	630 470	630 470	Two at 570 425
AUXILIARY BATTERY Cold Cranking Amps @ 0° F @ -20° F Reserve Capacity Minutes @ 80° F	TP2 540 405	TP2 540 405	TP2 540 405	TP2 540 405	— — —	TP2 540 405	TP2 540 405	— — —	TP2 540 405	TP2 540 405	— — —	TP2 540 405	TP2 540 405	TP2 540 405	— — —	TP2 540 405	TP2 540 405	— — —
STANDARD ALTERNATOR Max. Capacity (Amps) Max. Watts @ 12 Volts Nominal Amp @ Idle approximately Drive Pulley Ratio Model Number	85 1020 30 3.2:1 CS130	85 1020 30 3.2:1 CS130	85 1020 30 3.2:1 CS130	85 1020 30 3.2:1 CS130	85 1020 30 3.0:1 CS130	85 1020 30 3.2:1 CS130	85 1020 30 3.2:1 CS130	85 1020 30 3.0:1 CS130	85 1020 30 3.2:1 CS130	85 1020 30 3.2:1 CS130	85 1020 30 3.0:1 CS130	85 1020 30 3.2:1 CS130	85 1020 30 3.2:1 CS130	85 1020 30 3.2:1 CS130	85 1020 30 3.0:1 CS130	85 1020 30 3.2:1 CS130	85 1020 30 3.2:1 CS130	85 1020 30 3.0:1 CS130
OPTIONAL ALTERNATOR Max. Capacity (Amps) Max. Watts @ 12 Volts Nominal Amp @ Idle approximately Drive Pulley Ratio Model Number	C60 100 1200 36 3.2:1 CS130	C60 100 1200 36 3.2:1 CS130	C60 100 1200 36 3.2:1 CS130	C60 100 1200 36 3.2:1 CS130	C60 100 1200 36 3.0:1 CS130	C60 100 1200 36 3.2:1 CS130	C60 100 1200 36 3.2:1 CS130	C60 100 1200 36 3.0:1 CS130	C60 100 1200 36 3.2:1 CS130	C60 100 1200 36 3.2:1 CS130	C60 100 1200 36 3.0:1 CS130	C60 100 1200 36 3.2:1 CS130	C60 100 1200 36 3.2:1 CS130	C60 100 1200 36 3.2:1 CS130	C60 100 1200 36 3.0:1 CS130	C60 100 1200 36 3.2:1 CS130	C60 100 1200 36 3.2:1 CS130	C60 100 1200 36 3.0:1 CS130

NOTE: This alternator is available only as part of noted RPO.

ALTERNATOR CURVES

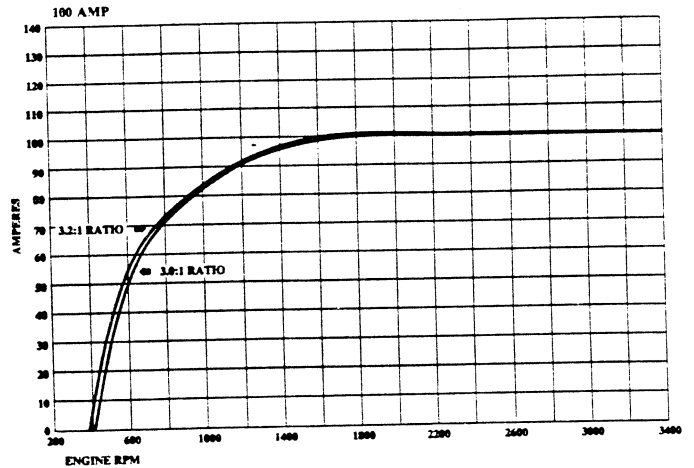
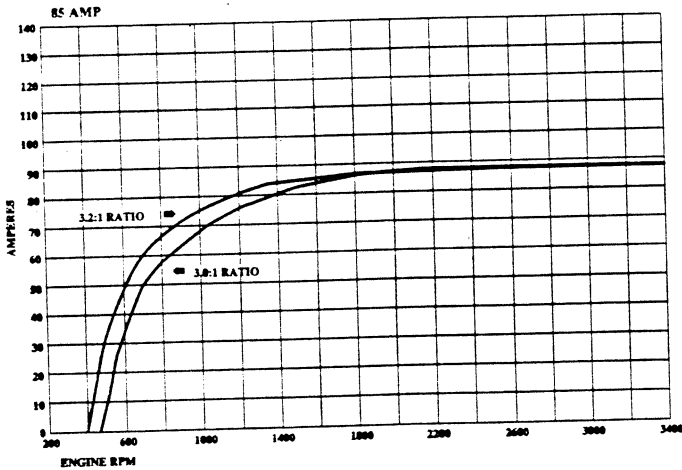

KEY: Reg Type Manual and Automatic Transmission **Bold Type** Automatic Transmission Only

TWO-WHEEL DRIVE AND FOUR-WHEEL DRIVE MODELS

MODEL	C/K1500 REG. CAB SPORTSIDE/ FLEETSIDE	C/K1500-CK2500 REG. CAB-EXT. CAB FLEETSIDE	C/K3500 REG. CAB-EXT. CAB FLEETSIDE
MODEL NUMBER	C/K10703/E62 C/K10703/E63	C/K10753-C/K10903-C/K10953/E63 C/K20753-C/K20903-C/K20953/E63	C/K30903 C/K30953/E63

STANDARD COOLING SYSTEM

ENGINE	4.3L	5.0L	5.7L	4.3L	5.0L	5.7L	6.2L ¹	7.4L	5.7L	7.4L	6.2L
Radiator Thickness (in.)	.93	.93	1.34	.93	.93	1.34	1.58	2.17	1.34	2.17	1.58
System Cap. (gal.)	3.6	3.8	3.9	3.6	3.8	3.9	6.2	6.3	3.9	6.3	6.2
Fan - No. Blades x Diameter x Pitch (in.)	3 x 19 x 2.0			3 x 19 x 2.0	3 x 19 x 2.0	3 x 19 x 2.0	5 x 20 x 2.56	5 x 20 x 2.56	3 x 19 x 2.0	5 x 20 x 2.56	5 x 20 x 2.56

OPTIONAL COOLING SYSTEMS

ENGINE	4.3L	5.0L	5.7L	4.3L	5.0L	5.7L	6.2L ¹	7.4L	5.7L	7.4L	6.2L
AUTOMATIC TRANS.	MX0			MX0			MX0			MX0	
Radiator Thickness (in.)	.93	1.34	1.34	.93	1.34	1.34	1.58	2.17	1.34	2.17	1.58
System Capacity (gal.)	3.6	3.8	3.8	3.6	3.8	3.8	6.2	6.3	3.8	6.3	6.2
Fan - No. Blades x Diameter x Pitch (in.)	3 x 19 x 2.0			3 x 19 x 2.0	3 x 19 x 2.0	3 x 19 x 2.0	5 x 20 x 2.56	5 x 20 x 2.56	5 x 19.5 x 2.0	5 x 20 x 2.56	5 x 20 x 2.56
OPT. H.D. RADIATOR	V01 ²			V01 ²			V01 ²			V01 ²	
Radiator Thickness (in.)	1.34	.93	1.34	1.34	.93	1.34	2.17	2.17	1.34	2.17	—
System Capacity (gal.)	3.6	4.2	3.9	3.6	4.2	3.9	6.2	6.3	3.8	6.3	—
Fan - No. Blades x Diameter x Pitch (in.)	5 x 19.5 x 2.0			5 x 19.5 x 2.0	5 x 19.5 x 2.0	5 x 19.5 x 2.0	5 x 20 x 2.56	5 x 20 x 2.56	5 x 19.5 x 2.0	5 x 20 x 2.56	5 x 20 x 2.56
OPT. AIR CONDITIONING	C60			C60			C60			C60	
Radiator Thickness (in.)	1.34	.93	1.34	1.34	.93	1.34	1.58	2.17	1.34	2.17	2.17
System Capacity (gal.)	3.6	3.8	3.9	3.6	3.8	3.9	6.2	6.3	3.9	6.3	6.2
Fan - No. Blades x Diameter x Pitch (in.)	5 x 19.5 x 2.0			5 x 19.5 x 2.0	5 x 19.5 x 2.0	5 x 19.5 x 2.0	5 x 20 x 2.56	5 x 20 x 2.56	5 x 19.5 x 2.0	5 x 20 x 2.56	5 x 20 x 2.56
OPT. ENG. OIL COOLER	KC4			KC4	KC4	KC4	—	KC4	—	KC4	—
Radiator Thickness (in.)	1.34			1.34	1.34	1.34	—	2.17	—	2.17	—
System Capacity (gal.)	3.6	3.9	3.9	3.6	3.9	3.9	—	6.2	—	6.2	—
Fan - No. Blades x Diameter x Pitch (in.)	5 x 19.5 x 2.0			5 x 19.5 x 2.0	5 x 19.5 x 2.0	5 x 19.5 x 2.0	—	5 x 20 x 2.56	—	5 x 20 x 2.56	—
OPT. TRANS OIL COOLER AND ENG. OIL COOLER	KC4/ V02			KC4/ V02	KC4/ V02	KC4/ V02	—	KC4/ V02	—	KC4/ V02	—
Radiator Thickness (in.)	1.34			1.34	1.34	1.34	—	2.17	—	2.17	—
System Capacity (gal.)	3.6	3.9	3.9	3.6	3.9	3.9	—	6.2	—	6.2	—
Fan - No. Blades x Diameter x Pitch (in.)	5 x 19.5 x 2.0			5 x 19.5 x 2.0	5 x 19.5 x 2.0	5 x 19.5 x 2.0	—	5 x 20 x 2.56	—	5 x 20 x 2.56	—
OPT. H.D. RADIATOR AND ENGINE OIL COOLER	V02 ³			V02 ³			V02 ³			V02 ³	
Radiator Thickness (in.)	1.34	1.34	1.34	1.34	1.34	1.34	2.17	2.17	—	2.17	—
System Capacity (gal.)	3.9	3.9	3.9	3.9	3.9	3.9	6.2	6.2	—	6.2	—
Fan - No. Blades x Diameter x Pitch (in.)	5 x 19.5 x 2.0	5 x 19.5 x 2.0	5 x 19.5 x 2.0	5 x 19.5 x 2.0	5 x 19.5 x 2.0	5 x 19.5 x 2.0	5 x 20 x 2.56	5 x 20 x 2.56	—	5 x 20 x 2.56	—
OPT. AIR CONDITIONING AND TRANS. OIL COOLER							C60/ K34				
Radiator Thickness (in.)	—	—	—	—	—	—	2.17	—	—	—	—
System Capacity (gal.)	—	—	—	—	—	—	6.2	—	—	—	—
Fan - No. Blades x Diameter x Pitch (in.)	—	—	—	—	—	—	5 x 20 x 2.56	—	—	—	—

¹6.2 Diesel N/A in California on C/K1500 Series Model.

² N/A C60 Air or V02 Cooling.

³ Included w/Z82 Trailering.

C/K REGULAR CAB MODELS

MODEL	C/K 1500 PICKUP SPORTSIDE	C/K 1500 PICKUP FLEETSIDE	C/K 2500 PICKUP FLEETSIDE	C/K 3500 PICKUP FLEETSIDE
MODEL NUMBER	CC10703/E62 CC10703/E63 CK10703/E62 CK10703/E63	CC10903/E63 CK10903/E63	CC20903/E63 CK20903/E63 C6P	CC30903 CK30903

EXTERIOR

BODY					
Wheelbase (in.)	WB	117.5	131.5	131.5	131.5
Overall Length (in.) w/o Rear Bumper	OAL	194.0	194.1	212.6	212.6
Overall Height (in.) Nominal	OAH	2WD 70.4 4WD 73.8	2WD 70.4 4WD 73.8	2WD 73.0 4WD 74.3	2WD 75.5 4WD 75.8
Maximum Width (in.)	OAW	77.1	76.8	76.8	94.2
Bumper to Axle Front (in.)	BA	34.9	34.9	34.9	34.9
Rear (in.)		47.25	47.27	52.2	52.2
Cab Axle (in.)	CA	41.8	55.9	55.9	55.9
Cab to End of Frame (in.)	—	78.7	97.6	97.6	97.6
Bumper to Back of Cab (in.)	BBC	110.6	110.6	110.6	110.6
Ground To Top of Rear Load Floor (in.)	GF	2WD 29.0 4WD 32.4	2WD 29.0 4WD 32.4	2WD 31.6 4WD 32.9	2WD 34.2 4WD 34.4
Ground Clearance (in.) Front/Rear	—	2WD 7.0/8.4 4WD 8.6/9.0	2WD 7.0/8.4 4WD 8.6/9.0	2WD 7.8/7.8 4WD 8.7/7.7	2WD 8.4/8.1 4WD 7.8/8.1
CARGO BOX					
Inside Length At Floor (in.)	IBL	78.7	97.6	97.6	97.6
Inside Length At Top (in.) Rear	IWR	49.1	61.9	61.9	61.9
Inside Width At Floor (in.)	IWF	49.1	64.7	64.7	64.7
Inside Width At Wheelhousing (in.)	IWW	49.1	49.1	49.1	49.1
Inside Height (in.)	—	19.3	19.3	19.3	19.3
Tailgate Width (in.) Top	—	50.9	62.0	62.0	62.0
SIGN PANEL AREA (in.)	Shaded Area	17 x 48 ³ / ₄	17 x 48 ³ / ₄	17 x 48 ³ / ₄	17 x 48 ³ / ₄

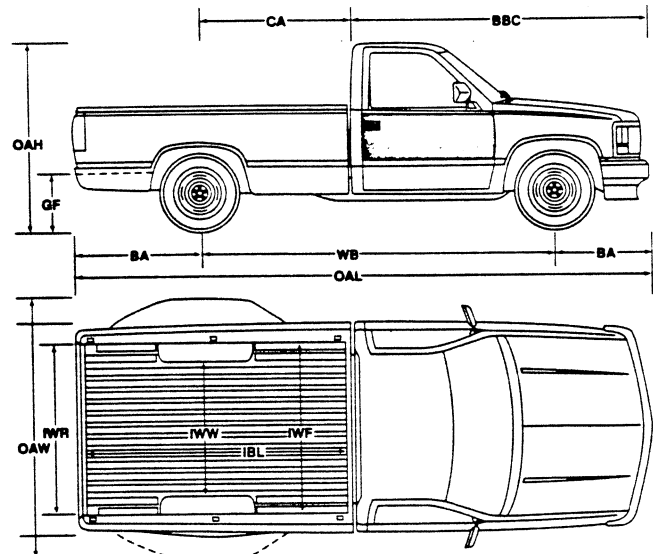
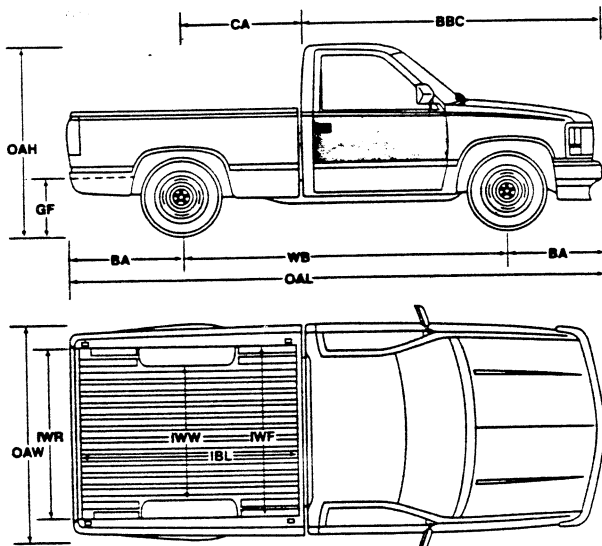

C/K EXTENDED CAB MODELS

MODEL	C/K 1500 PICKUP EXT. CAB FLEETSIDE		C/K 2500 PICKUP EXT. CAB FLEETSIDE			C/K 3500 PICKUP EXT. CAB FLEETSIDE
MODEL NUMBER	CC10753/E62 CK10753/E62	CC10953/E63 CK10953/E63	CC20753/E63 CK20753/E63	CC20953/E63 CK20953/E63		CC30953/E63 CK30953/E63
				C6P		

EXTERIOR DIMENSIONS

BODY							
Wheelbase (in.)	WB	141.5	155.5	141.5	155.5	155.5	155.5
Overall Length (in.) w/o Rear Bumper	OAL	218.0	237.0	218.0	237.0	212.6	237.0
Overall Height (in.) Nominal	OAH	2WD 70.6 4WD 73.8		2WD 74.0 4WD 74.4	2WD 74.0 4WD 74.4	2WD 75.6 4WD 75.8	2WD 75.6 4WD 75.8
Maximum Width (in.)	OAW	76.8			76.8		94.2
Bumper to Axle Front (in.)	BA	34.9	34.9	34.9	34.9	34.9	34.9
Rear (in.)		47.27	52.2	47.27	52.2	52.2	52.2
Cab Axle (in.)	CA	41.8	55.9	41.8	55.9	55.9	55.9
Cab to End of Frame (in.)	—	78.7	97.6	78.7	97.6	97.6	97.6
Bumper to back of Cab (in.)	BBC	134.6			134.6		134.6
Ground To Top of Rear Load Flr. (in.)	GF	2WD 29.0 4WD 32.4		2WD 31.6 4WD 32.9	2WD 31.6 4WD 32.9	2WD 34.0 4WD 34.4	2WD 34.0 4WD 34.4
Ground Clearance (in.) Front/Rear	—	2WD 7.2/7.1 4WD 9.2/9.6		2WD 7.9/7.7 4WD 9.2/8.2	2WD 7.9/7.7 4WD 9.2/8.2	2WD 8.4/8.0 4WD 9.2/8.1	2WD 7.9/7.6 4WD 7.2/7.4
CARGO BOX							
Inside Length At Floor (in.)	IBL	78.7	97.6	78.6	97.6	97.6	97.6
Inside Width At Top Rear (in.)	IWR	61.9			61.9		61.9
Inside Width At Floor (in.)	IWF	64.7			64.7		64.7
Inside Width At Wheelhousing (in.)	IWW	49.1			49.1		49.1
Inside Height (in.)	—	19.3			19.3		19.3
Tailgate Width (in.) Top	—	62.0			62.0		62.0
SIGN PANEL AREA (in.)	Shaded Area	17 x 77 1/2			17 x 77 1/2		17 x 77 1/2

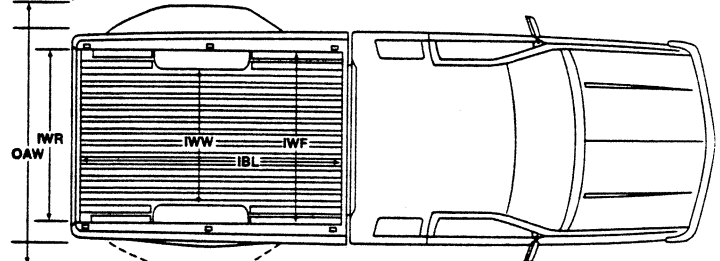
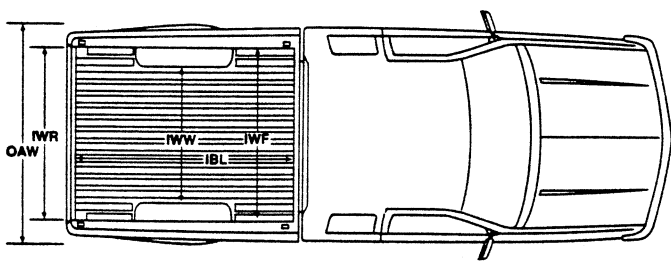
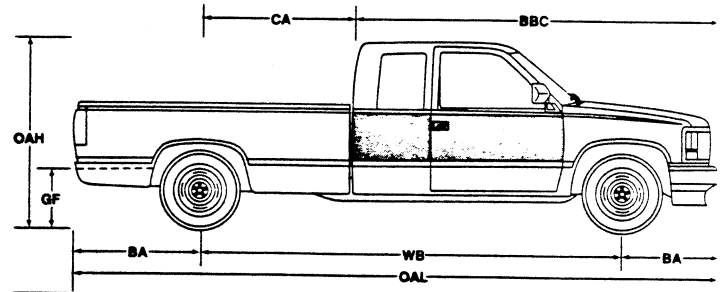
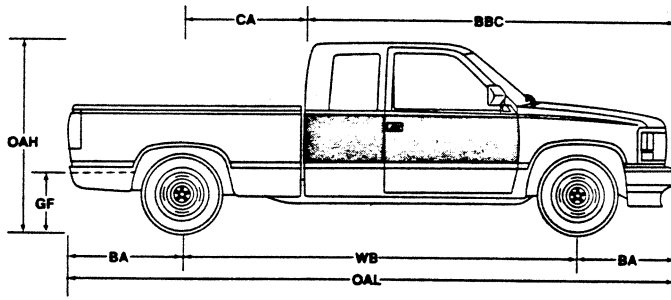

C/K REGULAR CAB MODELS

MODEL	C/K 1500 PICKUP SPORTSIDE	C/K 1500 PICKUP FLEETSIDE	C/K 2500 PICKUP FLEETSIDE	C/K 3500 PICKUP FLEETSIDE
MODEL NUMBER	CC10703/E62, CK10703/E62 CC10703/E63, CK10703/E63	CC10903/E63, CK10903/E63	CC20903/E63, CK20903/E63	CC30903/E63, CK30903/E63

INTERIOR

CAB					
Head Room (in.)	HR	40.0	40.0	40.0	40.0
Leg Room (in.)	LR	41.7	41.7	41.7	41.7
Shoulder Room (in.)	SR	66.0	66.0	66.0	66.0
Hip Room (in.)	HP	60.7	60.7	60.7	60.7

FUEL TANK

Std. Tank Nominal (gal.)	25.0	34.0	34.0	34.0
Location of Tank	Inboard LH Frame Rail	Inboard LH Frame Rail	Inboard LH Frame Rail	Inboard LH Frame Rail
Location of Filler	Left Side	Left Side	Left Side	Left Side

C/K EXTENDED CAB MODELS

MODEL	C/K 1500 PICKUP FLEETSIDE		C/K 2500 PICKUP FLEETSIDE		C/K 3500 PICKUP FLEETSIDE	
MODEL NUMBER	CC10753/E63 CK10753/E63	CC10953/E63 CK10953/E63	CC20753/E63 CK20753/E63	CC20953/E63 CK20953/E63	CC30953/E63	CK30953/E63

INTERIOR

CAB				
Head Room (in.)	HR	40.0	40.0	40.0
Leg Room (in.)	LR	41.7	41.7	41.7
Shoulder Room (in.)	SR	66.0	66.0	66.0
Hip Room (in.)	HP	60.7	60.7	60.7
Extended Cab Cargo Volume (cu. ft.) w/o Rear Seat	CV	40.5	40.5	40.5

FUEL TANK

Std. Tank Nominal (gal.)	25.0	34.0	25.0	34.0	34.0
Location of Tank	Inboard LH Frame Rail		Inboard LH Frame Rail		Inboard LH Frame Rail
Location of Filler	Left Side		Left Side		Left Side

OPTIONS

- KEY S - Standard
O - Optional
— Not Available
- | | | | |
|----------------|-----------------|-----------------|-----------------|
| 1. CC10703/E62 | 6. CC20903/E63 | 11. CK10703/E62 | 16. CK20903/E63 |
| 2. CC10703/E63 | 7. CC20753/E63 | 12. CK10703/E63 | 17. CK20753/E63 |
| 3. CC10903/E63 | 8. CC20953/E63 | 13. CK10903/E63 | 18. CK20953/E63 |
| 4. CC10753/E63 | 9. CC30903/E63 | 14. CK10753/E63 | 19. CK30903/E63 |
| 5. CC10953/E63 | 10. CC30953/E63 | 15. CK10953/E63 | 20. CK30953/E63 |

NOTE: Refer to Dealer Order Guide for Updated Option Availability.

		2-WHEEL DRIVE										4-WHEEL DRIVE									
		1	2	3	4	5	6	7	8	9	10	11	12	13	14	15	16	17	18	19	20
AIR CONDITIONING	C60	Incls 100 Amp Alternator	w/L03 Eng and MX0 Trans. and 3.73 or 4.10 axle ratio req KC4 Eng Oil Cooler	O	O	O	O	O	O	O	O	O	O	O	O	O	O	O	O	O	O
ANALOG GAGES	U16	With Tachometer	Std on 454SS	O	O	O	O	O	O	O	O	O	O	O	O	O	O	O	O	O	O
AXLES, REAR				O	O	O	O	O	O	O	O	O	O	O	O	O	O	O	O	O	O
Locking Differential	G80			O	O	O	O	O	O	O	O	O	O	O	O	O	O	O	O	O	O
BATTERY				O	O	O	O	O	O	O	O	O	O	O	O	O	O	O	O	O	O
Heavy Duty, Auxiliary	TP2	Delco Freedom 540 Cold Cranking Amps	N/A on WT1500 Incl w/Z81 Camper; N/A B3J Diesel Equipment	O	O	O	O	O	O	O	O	O	O	O	O	O	O	O	O	O	O
BEDLINER	BZY	Pickup Box	N/A P13 Wheel Carrier	-	O	O	O	O	O	O	O	-	O	O	O	O	O	O	O	O	O
BUMPER EQUIPMENT				-	O	O	O	O	O	O	O	-	O	O	O	O	O	O	O	O	O
Bumper, Painted	V43	Rear Step	Reqs E63 Body	-	O	O	O	O	O	O	O	-	O	O	O	O	O	O	O	O	O
Bumper, Chromed	VB3	Rear Step w/Rub Strip	E63 Body reqs Z62 Scottsdale or YE9 Silverado or VG3	O	O	O	O	O	O	O	O	O	O	O	O	O	O	O	O	O	O
Bumper, Chromed	VG3	Front Deluxe w/Rub Strip	Avail w/E62 Sportside only; Incl w/Z62 Scottsdale or YE9 Silverado	O	-	-	-	-	-	-	-	O	-	-	-	-	-	-	-	-	-
Guards, Front Bumper	V27	Black	N/A on WT1500. E63 Body reqs YE9 Silverado or Z62 Scottsdale. E62 Body reqs VG3 Bumper.	O	O	O	O	O	O	O	O	O	O	O	O	O	O	O	O	O	O
CAMPER SPECIAL CHASSIS EQUIPMENT	Z81	Basic Camper Group Incls DF2 Mirrors, Camper Wiring Harness; also TP2 (H.D. Aux.) Battery w/o B3J Diesel Equipment	N/A D45 Mirrors; MX0 Trans. reqs V02 Cooling; MM4 or MM5 Trans. reqs V01 Cooling or C60 Air; w/o B3J Diesel and C6P reqs KC4 Cooling	-	-	-	-	-	-	-	-	-	-	-	-	-	-	-	-	-	-
CARRIER, SPARE WHEEL AND TIRE	P13	Side Mounted	N/A ZQ8 Sport Chassis, BZY Bedliner or w/ R05 Wheels	-	-	O	-	O	O	-	O	-	-	O	-	O	O	-	O	-	-
CHASSIS	F44	Heavy-Duty Incl w/B3J Diesel Equip	Reqs XCN, XFL, XFM or XFN Tires on C10903; K10703 reqs 3.42 Axle; N/A PF4 Wheels	-	-	O	-	-	-	-	-	O	O	O	O	-	-	-	-	-	-
COLD-CLIMATE PACKAGE	V10	Incls Engine Block Heater, Special Insulation and Anti-Freeze Protection to -32° F	N/A B3J Diesel	O	O	O	O	O	O	O	O	O	O	O	O	O	O	O	O	O	O
CONVENIENCE PACKAGE				O	O	O	O	O	O	O	O	O	O	O	O	O	O	O	O	O	O
Driver's	ZQ3	Incls Electronic Speed Control and Comfortilt Steering Wheel	N/A WT1500; Std on 454SS	O	O	O	O	O	O	O	O	O	O	O	O	O	O	O	O	O	O
Operating	ZQ2	Incls Power Door Locks and Power Windows	N/A WT1500; Std on 454SS	O	O	O	O	O	O	O	O	O	O	O	O	O	O	O	O	O	O
COOLING SYSTEM				O	O	O	O	O	O	O	O	O	O	O	O	O	O	O	O	O	O
Engine Oil Cooler	KC4		N/A w/B3J Diesel Engine. Reqs V02 Cooling w/MX0 Trans L05 or L19 Eng; Incl w/Z82 Trailing.	O	O	O	O	O	O	O	O	O	O	O	O	O	O	O	O	O	O
Radiator, Heavy-Duty	V01		N/A V02 Cooling; C1500 w/C60 Air reqs LH6 Diesel and 3.08 or 3.42 Axle (K1500 and C/K2500 w/C60 Air reqs LH6 and 3.42 only); LL4 Diesel reqs 3.73 Axle and KC4 Eng Oil Cooler on C/K2500; N/A WT1500 or 454SS; C/K2500 N/A w/LB4 Eng w/C6P; C/K3500 N/A w/C60, MX0 Trans reqs L05	O	O	O	O	O	O	O	O	O	O	O	O	O	O	O	O	O	O
Radiator and Transmission Oil Cooler, Heavy-Duty	V02		Reqs MX0 Trans Incl w/Z82 Trailing; N/A V01 Cooling; LB4 or L05 Eng and C60 Air reqs KC4 Eng Oil Cooler	O	O	O	O	O	O	O	O	O	O	O	O	O	O	O	O	O	O

- S - Standard
 - O - Optional
 - Not Available
- | | | | |
|----------------|-----------------|-----------------|-----------------|
| 1. CC10703/E62 | 6. CC20903/E63 | 11. CK10703/E62 | 16. CK20903/E63 |
| 2. CC10703/E63 | 7. CC20753/E63 | 12. CK10703/E63 | 17. CK20753/E63 |
| 3. CC10903/E63 | 8. CC20953/E63 | 13. CK10903/E63 | 18. CK20953/E63 |
| 4. CC10753/E63 | 9. CC30903/E63 | 14. CK10753/E63 | 19. CK30903/E63 |
| 5. CC10953/E63 | 10. CC30953/E63 | 15. CK10953/E63 | 20. CK30953/E63 |

NOTE: Refer to Dealer Order Guide for Updated Option Availability.

OPTION CODE DESCRIPTION RESTRICTIONS				2-WHEEL DRIVE										4-WHEEL DRIVE									
				1	2	3	4	5	6	7	8	9	10	11	12	13	14	15	16	17	18	19	20
DEFOGGER	C49	Rear Window	N/A A28 Window or BYP Sport Pkg; Reqs YE9 Silverado or Z62 Scottsdale; N/A on WT1500 or 454SS	O	O	O	O	O	O	O	O	O	O	O	O	O	O	O	O	O	O	O	O
ENGINES		(See Powertrains)		S	S	S	S	S	S	S	S	S	S	S	S	S	S	S	S	S	S	S	S
4.3-liter V6 EFI	LB4			O	O	O	O	O	O	O	O	O	O	O	O	O	O	O	O	O	O	O	O
5.0-liter V8 EFI	L03			O	O	O	O	O	O	O	O	O	O	O	O	O	O	O	O	O	O	O	O
5.7-liter V8 EFI	L05			O	O	O	O	O	O	O	O	O	O	O	O	O	O	O	O	O	O	O	O
7.4-liter V8 EFI	L19		C/K2500 at 8600 GVWR only	-	O	-	-	-	O	-	O	O	O	-	-	-	-	-	O	O	O	O	O
6.2-liter V8 Diesel	LH6			-	-	O	O	O	O	O	O	O	O	-	-	O	O	O	O	O	O	O	O
6.2-liter V8 H.D. Diesel	LL4			-	-	-	-	O	O	O	O	O	O	-	-	-	-	O	O	O	O	O	O
FILLER CAP, FUEL	N05	Locking		O	O	O	O	O	O	O	O	O	O	O	O	O	O	O	O	O	O	O	O
GLASS				-	-	-	O	O	-	O	O	-	O	-	-	O	O	-	O	O	-	O	O
Deep Tinted	AJ1	Incls A20 Swing-Out Quarter Windows	N/A w/A28 Sliding Rear Windows or C49 Defogger; Ext Cab only																				
HARNESS, WIRING	UY7	Trailer, Heavy-Duty 7-Lead; Incl w/Z82 Trailering		O	O	O	O	O	O	O	O	O	O	O	O	O	O	O	O	O	O	O	O
LAMPS				O	O	O	O	O	O	O	O	O	O	O	O	O	O	O	O	O	O	O	O
Cargo Area	UF2	Incl w/TR9 Lighting	N/A on WT1500																				
Dome and Reading	C95	Incl w/TR9 Lighting	N/A on WT1500																				
Roof Marker	U01	Incl w/R05 Wheels	N/A w/YF5 CA. Emissions; N/A on WT1500 or 454SS;																				
LICENSE PLATE BRACKET	VK3	Front		O	O	O	O	O	O	O	O	O	O	O	O	O	O	O	O	O	O	O	O
LIGHTING, AUXILIARY	TR9	Incls C95 Dome and Reading Lamps and Ashtray, Glove Box and Underhood Lamps	N/A on WT1500; Std on 454SS	O	O	O	O	O	O	O	O	O	O	O	O	O	O	O	O	O	O	O	O
MIRRORS, EXTERIOR (LH/RH)				O	O	O	O	O	O	O	O	O	O	O	O	O	O	O	O	O	O	O	O
Below-Eye-Line Type	D45	Stainless Steel, 9.0" x 6.5"	N/A on WT1500 or 454SS																				
Camper Type	DF2	Stainless Steel; Incl w/Z81 Camper; 7.5" x 10.5"		O	O	O	O	O	O	O	O	O	O	O	O	O	O	O	O	O	O	O	O
MOLDINGS				O	O	O	O	O	O	O	O	O	O	O	O	O	O	O	O	O	O	O	O
Body Side	B84	Black; Incl w/Z62 Scottsdale w/o BYP Sport Package	N/A w/BYP; N/A w/YE9 Silverado or B85 Moldings; N/A R05 Wheels; N/A on WT1500 or 454SS																				
Body Side	B85	Bright; Incl w/YE9 Silverado w/o BYP Sport Package	N/A Std Decor; N/A R05 Wheels; N/A B84 Moldings; N/A on WT1500 or 454SS																				
OFF-ROAD CHASSIS PACKAGE	Z71	Incls Bilstein Shocks and NZZ Skid Plate	Reqs XGL or XGM Tires; N/A F60 Springs or F51 Shocks	-	-	-	-	-	-	-	-	-	-	O	O	O	O	O	O	-	-	-	-
PAINT, EXTERIOR		(See Color and Trim)		S	S	S	S	S	S	S	S	S	S	S	S	S	S	S	S	S	S	S	S
Solid	ZY1			O	O	O	O	O	O	O	O	O	O	O	O	O	O	O	O	O	O	O	O
Conventional Two-Tone	ZY2		N/A on WT1500 or 454SS																				
Special Two-Tone	ZY3		N/A on WT1500 or 454SS																				
Deluxe Two-Tone	ZY4		N/A on WT1500 or 454SS																				

- KEY** S - Standard
 O - Optional
 — Not Available
- | | | | |
|----------------|-----------------|-----------------|-----------------|
| 1. CC10703/E62 | 6. CC20903/E63 | 11. CK10703/E62 | 16. CK20903/E63 |
| 2. CC10703/E63 | 7. CC20753/E63 | 12. CK10703/E63 | 17. CK20753/E63 |
| 3. CC10903/E63 | 8. CC20953/E63 | 13. CK10903/E63 | 18. CK20953/E63 |
| 4. CC10753/E63 | 9. CC30903/E63 | 14. CK10753/E63 | 19. CK30903/E63 |
| 5. CC10953/E63 | 10. CC30953/E63 | 15. CK10953/E63 | 20. CK30953/E63 |

NOTE: Refer to Dealer Order Guide for Updated Option Availability.

OPTION	CODE	DESCRIPTION	RESTRICTIONS	2-WHEEL DRIVE										4-WHEEL DRIVE									
				1	2	3	4	5	6	7	8	9	10	11	12	13	14	15	16	17	18	19	20
RADIO EQUIPMENT																							
AM Radio	U63		Opt on WT1500	S	S	S	S	S	S	S	S	S	S	S	S	S	S	S	S	S			
Radio Delete	UL5		Std on WT1500 Avail w/P.E.G., P1A1, P2A1, P3A1 only	O	O	O	O	O	O	O	O	O	O	O	O	O	O	O	O	O			
Electronically-Tuned AM/FM Stereo Radio w/Seek-Scan and Digital Clock	UM7	12 Presets, Digital Display, Two Front/Two Rear 4" x 6" ERS Speakers, 26 Watts Total Power Output	Incl w/YE9 Silverado	O	O	O	O	O	O	O	O	O	O	O	O	O	O	O	O	O			
Electronically-Tuned AM/FM Stereo Radio w/Seek-Scan, Stereo Cassette Tape and Digital Clock	UM6	12 Presets, Digital Display, Two Front/Two Rear 4" x 6" ERS Speakers, 26 Watts Total Power Output		O	O	O	O	O	O	O	O	O	O	O	O	O	O	O	O	O			
Electronically-Tuned AM Stereo/FM Stereo Radio w/Seek-Scan, Stereo Cassette Tape w/Search- Repeat, Graphic Equalizer and Digital Clock	UX1	12 Presets, Digital Display, Two Front/Two Rear ERS Speakers, 26 Watts Total Power Output		O	O	O	O	O	O	O	O	O	O	O	O	O	O	O	O	O			
SCOTTSDALE	Z62	(See Trim Level Section)	N/A on WT1500 or 454SS	O	O	O	O	O	O	O	O	O	O	O	O	O	O	O	O	O			
SEATS																							
Reclining High-Back, Front Bucket	A95		Std on 454SS; N/A on WT1500	O	O	O	O	O	O	O	O	O	O	O	O	O	O	O	O	O			
SHOCK ABSORBERS																							
Front/Rear, Heavy-Duty	F51	Incl w/Z82 Trailering	N/A Z71 Off-Road Chassis or ZQ8 Sport Suspension	O	O	O	O	O	O	O	O	O	O	O	O	O	O	O	O	O			
SILVERADO	YE9	(See Trim Level Section)	N/A on WT1500	O	O	O	O	O	O	O	O	O	O	O	O	O	O	O	O	O			
SKID PLATE	NZZ	Off-Road; Incl w/Z71 Off- Road Chassis Package		O	O	O	O	O	O	O	O	O	O	O	O	O	O	O	O	O			
SPORT EQUIPMENT PACKAGE	BYP	C10703 — Includes Up- level Black Grille, Composite Headlamps, Body Color Front Bumper, Body Color Rear Bumper w/Rub Strip and Step Pad, Fog Lamps, Special Body Side Moldings, Chrome Plated 15.0" Wheels, Black Mirrors and Sport Identification Decals K10703 — Includes Up- level Black Grille, Composite Headlamps, Black Front Bumper, Black Rear Bumper w/Step Pad, Black Mirrors, Black Wheel Flares, Aluminum Wheels and 4x4 Sport Identification Decals	Reqs P235/75R15 Tires without ZQ8 Sport Suspension ZQ8 reqs P275/60R15 Tires Reqs LT265/75R16C Tires	O	O	O	O	O	O	O	O	O	O	O	O	O	O	O	O	O			
SPORT PERFORMANCE PACKAGE	B4U	(See Trim Level Section)	N/A on WT1500	O	O	O	O	O	O	O	O	O	O	O	O	O	O	O	O	O			
SPRINGS (TORSION BARS)	F60	Front, Heavy-Duty	N/A w/Diesel Eng, w/Z71 Off- Road Chassis Package or with 454SS. K1500 Series Reg Cab reqs F44 H.D. Chassis	O	O	O	O	O	O	O	O	O	O	O	O	O	O	O	O	O			
STEERING WHEEL, SPORT	NK3		Reqs YE9 Silverado; N/A on WT1500	O	O	O	O	O	O	O	O	O	O	O	O	O	O	O	O	O			
STRIPING	D85	(See Color and Trim)	Reqs ZY1 or ZY2 Paint; N/A on WT1500 or 454SS	O	O	O	O	O	O	O	O	O	O	O	O	O	O	O	O	O			
SUSPENSION, SPORT	ZQ8	Incls Bilstein Gas-Filled Shocks and 12.7:1 Ratio Steering	Reqs XCN Tires; LB4 or L05 Engine reqs 3.42 or 3.73 Rear Axle; N/A F51 Shocks, P13 Carrier, P01 Wheel Covers, N90 Wheels, B3J or WT1500	O	O	O	O	O	O	O	O	O	O	O	O	O	O	O	O	O			

- S - Standard
 - O - Optional
 - Not Available
- | | | | |
|----------------|-----------------|-----------------|-----------------|
| 1. CC10703/E62 | 6. CC20903/E63 | 11. CK10703/E62 | 16. CK20903/E63 |
| 2. CC10703/E63 | 7. CC20753/E63 | 12. CK10703/E63 | 17. CK20753/E63 |
| 3. CC10903/E63 | 8. CC20953/E63 | 13. CK10903/E63 | 18. CK20953/E63 |
| 4. CC10753/E63 | 9. CC30903/E63 | 14. CK10753/E63 | 19. CK30903/E63 |
| 5. CC10953/E63 | 10. CC30953/E63 | 15. CK10953/E63 | 20. CK30953/E63 |

NOTE: Refer to Dealer Order Guide for Updated Option Availability.

OPTION	CODE	DESCRIPTION	RESTRICTIONS	MODELS																			
				2-WHEEL DRIVE										4-WHEEL DRIVE									
				1	2	3	4	5	6	7	8	9	10	11	12	13	14	15	16	17	18	19	20
TIRE EQUIPMENT		(See Wheels and Tires for Details)	(Spare Tire is Optional on C/K2500 and C/K3500 Models)																				
P225/75R15	XEV YEV ZEV			O	O	O																	
P225/75R15	XET YET ZET			S	S	S																	
P235/75R15	XFL YFL ZFL		XFL and YFL Tires req w/BYP w/o ZQ8	O	O	O	S	S															
P235/75R15	XFM YFM ZFM			O	O	O	O	O															
P235/75R15	XFN YFN ZFN			O	O	O	O	O															
P275/60R15	XCN YCN ZCN		Reqs ZQ8	O	O	O	O	O															
LT225/75R16C	XHE YHE ZHE		(Incls YHP or YHR Rear Tires only)									S	S	S	S	S	S						
LT225/75R16C	XHJ YHJ ZHJ													O	O	O							
LT225/75R16C	XHN YHN ZHN													O	O	O							
LT225/75R16D	XHP YHP ZHP							S	S	S	O	O					S			S	S		
LT225/75R16D	XHR YHR ZHR																O			O	O		
LT245/75R16C	XBK YBK ZBK																S	S		S	S		
LT245/75R16C	XBN YBN ZBN																O	O		O	O		
LT245/75R16C	XBX YBX ZBX																O	O		O	O		
LT245/75R16E	XHH YHH ZHH		XHH Tires are opt w/YGK Rear Tires (C Models only)							O	O	O								O	O		
LT245/75R16E	XGK YGK ZGK																			O	O		
LT265/75R16C	XGL YGL ZGL		Std w/BYP Sport Package														O	O	O	O			
LT265/75R126C	XGM YGM ZGM																O	O	O	O			
7.50-16D	XDE YDE ZDE																O	O				O	O
7.50-16D	XDL YDL ZDL																					O	O

*Includes YHP or YHR Rear Tires on C Models Includes YHP Rear Tires only on K Models.

- KEY S - Standard
O - Optional
— Not Available
- | | | | |
|----------------|-----------------|-----------------|-----------------|
| 1. CC10703/E62 | 6. CC20903/E63 | 11. CK10703/E62 | 16. CK20903/E63 |
| 2. CC10703/E63 | 7. CC20753/E63 | 12. CK10703/E63 | 17. CK20753/E63 |
| 3. CC10903/E63 | 8. CC20953/E63 | 13. CK10903/E63 | 18. CK20953/E63 |
| 4. CC10753/E63 | 9. CC30903/E63 | 14. CK10753/E63 | 19. CK30903/E63 |
| 5. CC10953/E63 | 10. CC30953/E63 | 15. CK10953/E63 | 20. CK30953/E63 |

NOTE: Refer to Dealer Order Guide for Updated Option Availability.

OPTION	CODE	DESCRIPTION	MODELS																						
			2-WHEEL DRIVE										4-WHEEL DRIVE												
			1	2	3	4	5	6	7	8	9	10	11	12	13	14	15	16	17	18	19	20			
TOW HOOKS	V76	Front	N/A w/454SS			O O O O O O O O O O O O										S S S S S S S S S S S S									
TRAILERING SPECIAL EQUIPMENT, HEAVY-DUTY	Z82	Incls Wiring Harness, Platform Hitch, V02 H.D. Trans Oil Cooler, and F51 Shocks; Incls KC4 Cooler w/o B3J Diesel Equip; w/o Z71 or ZQ8 Incls Shock Absorbers; w/Z71 or ZQ8 Incls Bilstein Shocks	3.08 Rear Axle N/A w/LB4 Engine; Reqs MX0 Trans; Also reqs VB3 or V43 Bumper except on C/K10703, C/K10753 and C/K19053			O O O O O O O O O O O O										O O O O O O O O O O O O									
TRANSMISSIONS	MM4	(See Powertrains) 4-Speed Manual	N/A on WT1500			- - O O O O O O S S										O O O O O O O O S S									
	MM5	5-Speed Manual w/Overdrive				S S S S S S S S - -										S S S S S S S S - -									
	MM5 ¹	Heavy-Duty 5-Speed Manual Overdrive	Std on C/K1500 and C/K2500 Models w/B3J and C/K2500 Models w/C6P. Std on 454SS; N/A on WT1500			O O O O O O O O O O										O O O O O O O O O O									
	MX0	4-Speed Automatic w/Overdrive				O O O O O O O O O O										O O O O O O O O O O									
WHEEL TRIM Wheel Covers	P01		N/A w/454SS, YE9 Silverado, Z62 Scottsdale or ZQ8 Sport Suspension; N/A w/R05 Wheels			O O O O O O O O O O										O O O O O O O O O O									
	P06	Trim Rings				- - - - - - - - O O										- - - - - - - - O O									
WHEELS Aluminum, 15.0" x 7.0"	N90		N/A ZQ8, WT1500 or 454SS			O O O O O - - - - -										- - - - - - - - - -									
	PF4	Incl w/BYP Sport Package	N/A F44 H.D. Chassis, WT1500 or B3J Diesel			- - - - - - - - - -										O O O - - - - - - -									
WHEELS Dual Rear	R05	Incls U01 Lamps Incl with B3J Diesel Equipment	MX0 Trans reqs V02 Heavy-Duty Radiator and Trans Oil Cooler			- - - - - - - - O O										- - - - - - - - O O									
WINDOWS Sliding Rear	A28		N/A C49 Defogger			O O O O O O O O O O										O O O O O O O O O O									
WORK TRUCK PACKAGE	VLA	(See Trim Level Section)				- - O - - - - - - -										- - O - - - - - - -									

¹Available interim 1991. Check Order Guide for Notification of Availability.

SOLID COLOR (ZY1)

Solid color paint (ZY1) is standard on all models. All painted areas of the cab, front end sheet metal, and box are the same color. Outlined block "Chevrolet" decal lettering is applied to the tailgate. (A bright trim plate with lettering is applied on Fleetside models when the Silverado trim is ordered). The only available Color Code 1/Color Code 2 exterior paint combinations are those displayed in the chart below. Recommended interior trim colors are indicated by the symbol ●. For more information, refer to Seats and Interior Trim pages as well as the Truck Order Guide.

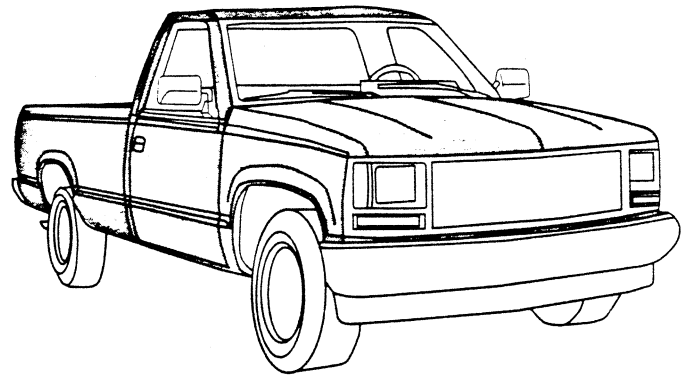

KEY: ●—Recommended ●—Not Available on C/K Extended Cab.

EXTERIOR COLORS		STRIPE COLORS	INTERIOR COLORS				
COLOR CODE 1	COLOR CODE 2	w/D85	Beige	Blue	Garnet	Gray	Saddle
22 Brilliant Blue Met.	22 Brilliant Blue Metallic	Lt. Blue		●			
27 Smoke Blue Met.	27 Smoke Blue Metallic	Lt. Blue		●			
	27 Smoke Blue Metallic	Silver				●	
30 Catalina Blue Met.	30 Catalina Blue Metallic	Lt. Blue		●			
	30 Catalina Blue Metallic	Silver				●	
41 Onyx Black	41 Onyx Black	Silver				●	
	41 Onyx Black	Gold					●
	41 Onyx Black	Lt. Blue		●			
	41 Onyx Black	Vermillion			●		
50 Summit White	41 Onyx Black	Lt. Beige	●				
	50 Summit White	Lt. Blue		●			
	50 Summit White	Gold					●
	50 Summit White	Vermillion			●		
58 Sandstone Met.	50 Summit White	Silver				●	
	50 Summit White	Lt. Beige	●				
	58 Sandstone Metallic	Vermillion	●				
	70 Flame Red	70 Flame Red	Gold				
70 Flame Red		Vermillion			●		
70 Flame Red		Silver				●	
94 Crimson Red Met.	94 Crimson Red Metallic	Gold					●
	94 Crimson Red Metallic	Silver				●	
	94 Crimson Red Metallic	Lt. Beige	●				
	94 Crimson Red Metallic	Vermillion			●		
96 Quicksilver Met.	96 Quicksilver Metallic	Lt. Blue		●			
	96 Quicksilver Metallic	Vermillion			●	●	
97 Slate Met.	97 Slate Metallic	Vermillion			●		
	97 Slate Metallic	Silver				●	

Colors

■ The paint samples below are representative of the exterior colors offered on the C/K Pickup. Refer to the Color and Trim availability charts to determine specific availability. Red indicates a new color for 1991.

22 BRILLIANT BLUE MET.



27 SMOKE BLUE MET.

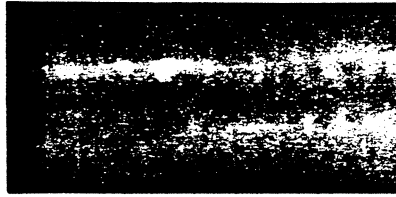

30 CATALINA BLUE MET.

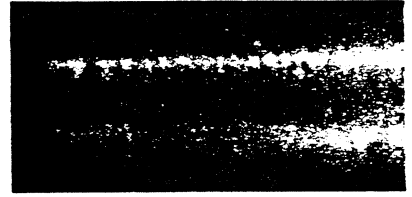

41 ONYX BLACK

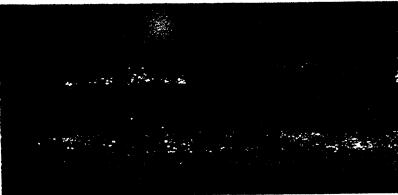

50 SUMMIT WHITE



58 SANDSTONE MET.

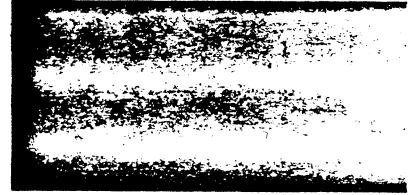

70 FLAME RED



94 CRIMSON RED MET.



96 QUICKSILVER MET.



97 SLATE MET.





A SADDLE VINYL B BLUE VINYL C GARNET VINYL D GRAY VINYL E BEIGE VINYL

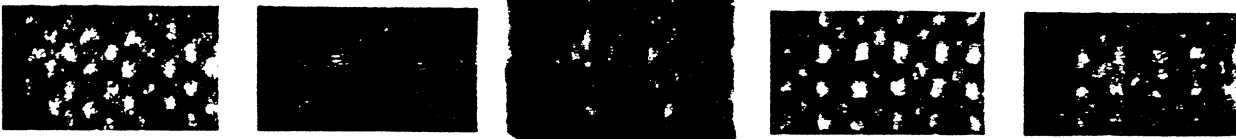

F SADDLE CLOTH G BLUE CLOTH H GARNET CLOTH I GRAY CLOTH J BEIGE CLOTH



K SADDLE CUSTOM VINYL L BLUE CUSTOM VINYL M GARNET CUSTOM VINYL N GRAY CUSTOM VINYL O BEIGE CUSTOM VINYL

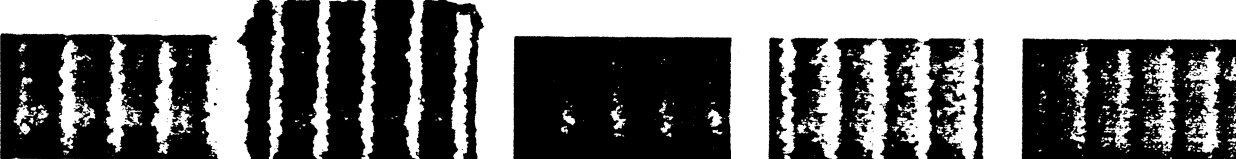

P SADDLE CUSTOM CLOTH Q BLUE CUSTOM CLOTH R GARNET CUSTOM CLOTH S GRAY CUSTOM CLOTH T BEIGE CUSTOM CLOTH

TRIM, SEAT AND INTERIOR COLOR SELECTION

MODEL	REGULAR CAB			EXTENDED CAB		
	CHEYENNE (Std)	SCOTTSDALE (Z62)	SILVERADO (YE9)	CHEYENNE (Std)	SCOTTSDALE (Z62)	SILVERADO (YE9)
TRIM (Code)						
SEAT (Code)	BENCH (***)	BENCH (***)	BENCH (***)	BENCH (***)	BENCH (***)	
Interior Color Availability	A Saddle Vinyl B Blue Vinyl C Garnet Vinyl D Gray Vinyl E Beige Vinyl F Saddle Cloth G Blue Cloth H Garnet Cloth I Gray Cloth J Beige Cloth	F Saddle Cloth G Blue Cloth H Garnet Cloth I Gray Cloth J Beige Cloth K Saddle Custom Vinyl L Blue Custom Vinyl M Garnet Custom Vinyl N Gray Custom Vinyl O Beige Custom Vinyl	K Saddle Custom Vinyl L Blue Custom Vinyl M Garnet Custom Vinyl N Gray Custom Vinyl O Beige Custom Vinyl P Saddle Custom Cloth Q Blue Custom Cloth R Garnet Custom Cloth S Gray Custom Cloth T Beige Custom Cloth	A Saddle Vinyl B Blue Vinyl C Garnet Vinyl F Saddle Cloth G Blue Cloth H Garnet Cloth	F Saddle Cloth G Blue Cloth H Garnet Cloth K Saddle Custom Vinyl L Blue Custom Vinyl M Garnet Custom Vinyl	
SEAT (Code)		SPLIT BENCH (***)	SPLIT BENCH (***)	SPLIT BENCH (***)	SPLIT BENCH (***)	SPLIT BENCH (***)
Interior Color Availability		K Saddle Custom Vinyl L Blue Custom Vinyl M Garnet Custom Vinyl	K Saddle Custom Vinyl L Blue Custom Vinyl M Garnet Custom Vinyl P Saddle Custom Cloth Q Blue Custom Cloth R Garnet Custom Cloth	A Saddle Vinyl B Blue Vinyl C Garnet Vinyl F Saddle Cloth G Blue Cloth H Garnet Cloth	F Saddle Cloth G Blue Cloth H Garnet Cloth K Saddle Custom Vinyl L Blue Custom Vinyl M Garnet Custom Vinyl	K Saddle Custom Vinyl L Blue Custom Vinyl M Garnet Custom Vinyl P Saddle Custom Cloth Q Blue Custom Cloth R Garnet Custom Cloth
SEAT (Code)		BUCKET SEAT (***)	BUCKET SEAT (***)		BUCKET SEAT (***)	BUCKET SEAT (***)
Interior Color Availability		K Saddle Custom Vinyl L Blue Custom Vinyl M Garnet Custom Vinyl	K Saddle Custom Vinyl L Blue Custom Vinyl M Garnet Custom Vinyl P Saddle Custom Cloth Q Blue Custom Cloth R Garnet Custom Cloth		K Saddle Custom Vinyl L Blue Custom Vinyl M Garnet Custom Vinyl	K Saddle Custom Vinyl L Blue Custom Vinyl M Garnet Custom Vinyl P Saddle Custom Cloth Q Blue Custom Cloth R Garnet Custom Cloth
SEAT (Code)			RECLINING HIGH-BACK BUCKET SEATS (***)	FOLDING REAR BENCH ¹	FOLDING REAR BENCH ¹	FOLDING REAR BENCH ¹
Interior Color Availability			P Saddle Custom Cloth Q Blue Custom Cloth R Garnet Custom Cloth S Gray Custom Cloth	Will Match Front Trim Ordered	Will Match Front Trim Ordered	Will Match Front Trim Ordered

¹Included when ordering Split Bench or Bucket Seats

C/K PICKUP

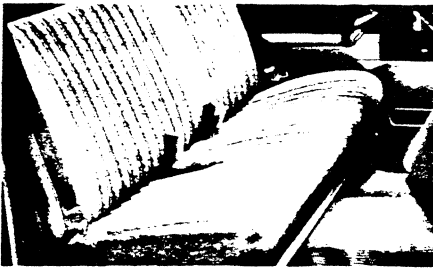

■ FULL FRONT BENCH SEAT

PASSENGER CAPACITY: 3

TRIM: Cheyenne (Std); Scottsdale (Z62); Silverado (YE9)

AVAILABILITY: Regular Cab; Extended Cab

ORDERING CODE: ***1

The standard foam bench seat features full width, full depth and will seat three passengers. It is available in Vinyl or Cloth for the Cheyenne (Std) Regular and Extended Cab models; in Cloth or Custom Vinyl for the Scottsdale (Z62) Regular Cab and Extended Cab models; or Custom Vinyl in the Silverado (YE9) Regular Cab only.

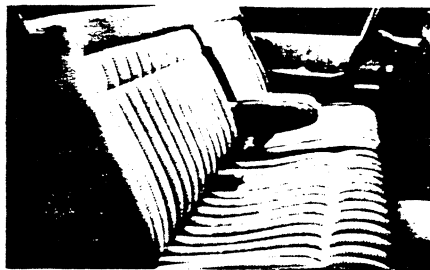

■ FULL FRONT BENCH SEAT

PASSENGER CAPACITY: 3

TRIM: Silverado (YE9) Custom Cloth only

AVAILABILITY: Regular Cab

ORDERING CODE: ***1

This seat features a folding armrest. It is standard when Custom Cloth is ordered with the Silverado (YE9) trim for Regular Cab models.



■ 60/40 SPLIT FRONT BENCH SEAT

PASSENGER CAPACITY: 3

TRIM: Cheyenne (Std) (Extended Cab only); Scottsdale (Z62); Silverado (YE9)

AVAILABILITY: Regular Cab; Extended Cab

ORDERING CODE: ***3

The foam bench seat features full width, full depth and includes a folding backrest. It seats three passengers and will split to allow each portion of the seats to fold individually. It is available in Vinyl or Cloth for the Cheyenne (Std) Extended Cab, Custom Vinyl for the Scottsdale (Z62) Regular Cab and Cloth or Custom Vinyl for the Scottsdale (Z62) Extended Cab. The Silverado (YE9) Regular Cab and Extended Cab are available in Custom Vinyl and Custom Cloth.

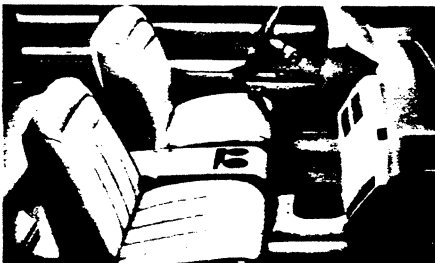

■ LOW-BACK FRONT BUCKET SEATS (DRIVER AND PASSENGER)

PASSENGER CAPACITY: 2

TRIM: Scottsdale (Z62); Silverado (YE9)

AVAILABILITY: Regular Cab; Extended Cab

ORDERING CODE: ***2

These optional bucket seats have foam padding and folding backrests with inertia latches. A Center Floor Console is included. It is available in Custom Vinyl for the Scottsdale (Z62), Regular and Extended Cab; Custom Vinyl and Custom Cloth for the Silverado (YE9), Regular and Extended Cab.



■ REAR BENCH SEAT

PASSENGER CAPACITY: 3

TRIM: Cheyenne (Std); Scottsdale (Z62); Silverado (YE9)

AVAILABILITY: Extended Cab models only

ORDERING CODE: Included with Bucket Seats or Split Bench Seat

This seat is included when choosing Bucket or Split Bench seats. It is a three passenger bench seat that also folds up to accommodate cargo. Seat trim will match front seat trim ordered.

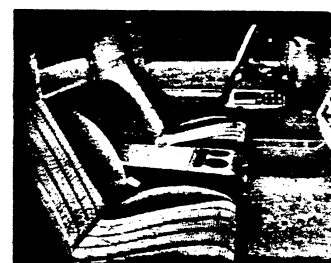

■ RECLINING HIGH-BACK FRONT BUCKET SEATS

PASSENGER CAPACITY: 2

TRIM: Silverado (YE9)

AVAILABILITY: Regular Cab only

ORDERING CODE: (**6/A95)

These foam padded high-back bucket seats include a center floor console. They are available in Custom Cloth only.

SPECIAL TRAILERING PACKAGES

The charts below indicate the required and recommended options for towing light, medium or heavy trailers with your new C/K Full-Size Pickup. They also provide Regular Production Option numbers (RPOs) to make ordering easy for you.

As the charts show, a Heavy-Duty Special Trailing Package (RPO Z82) is recommended or required, depending on the C/K series and the size of the trailer to be towed. The package includes:

- A weight-distributing hitch platform.
- A 7-wire wiring harness.
- A transmission oil cooler (RPO V02).
- Heavy-duty front and rear shock absorbers (1500 Series only).
- An engine oil cooler (RPO KC4) for gasoline-powered models.

For towing a light trailer (up to 2000-lbs. gross weight), the optional rear step bumper is an appropriate deadweight hitch, and requires a 1 7/8"-diameter hitch ball, available as an accessory.

For towing a medium trailer (up to 4000-lbs. gross weight, or with a tongue

weight of 400-lbs. or under), a 2"- diameter hitch ball (also available as an accessory) is required for the C/K's rear step bumper.

For towing a heavy trailer (up to 10,000-lbs. gross weight), a weight-distributing hitch platform is required. It's included in RPO Z82—Heavy-Duty Trailing Special Package—or from an outside supplier. If you plan to "fifth wheel" a trailer with a gross weight of up to 13,500-lbs., please take special note of the following:

There are two types of pickup fifth-wheel hitch installations. The first has the fifth wheel on a bar mounted on brackets attached to the frame and the bed of the pickup and supported by braces on the fender housings.

Note: Diagonal bracing between the brackets is required. The kingpin is mounted on the trailer. With the second type, the kingpin is mounted in the bed of the pickup box, and the fifth wheel is mounted on the trailer. This type of hitch is supplied and installed by the trailer manufacturer.

Fifth-wheel trailers have a greater percentage of their weight on the kingpin (tongue load) than a conventional trailer. Because

of this fact, greater attention must be given to the maximum allowable payload and GVWR. The maximum allowable payload and GVWR for each application should not be exceeded. The weight of any additional equipment and all passengers must be subtracted from the payload weight to determine the available kingpin load.

You will also have to splice a wiring harness into your Pickup's special connector to activate your trailer lights and other electrical systems. A 5-wire wiring harness is sufficient for light trailers and can be purchased from an outside supplier. For medium and heavy trailers, a 7-wire wiring harness is required. It's included in RPO Z82 (Heavy-Duty Trailing Package) or can be purchased separately from an outside supplier. The heavy-duty 7-wire harness necessary for fifth-wheel trailing can be purchased from an outside supplier.

Although C/K Pickups can be purchased with manual transmissions for towing purposes, Chevrolet strongly endorses the 4-speed automatic transmission. The charts indicate trailing equipment required in **bold type**.

WHEEL DRIVE GASOLINE-POWERED FULL-SIZE PICKUPS

Trailer Classification	Light			Medium			Heavy			
	2000			4000			7500	9000	10,000	10,000
Gross Trailer Weight (lbs.) up to ¹	200			400			850	1000	1000	1000
Maximum Tongue Load (lbs.)	C1500	C2500	C3500	C1500	C2500	C3500	C1500	C2500	C2500/C6P	C3500
Series										
Minimum Engine										
4.3L (262) V6 EFI	LB4	LB4	—	LB4	LB4	—	—	—	—	—
5.0L (305) V8 EFI	—	—	—	—	—	—	L03	L03	—	—
5.7L (350) V8 EFI	—	—	L05	—	—	L05	L05	L05	L05	L05
7.4L (454) V8 EFI	—	—	L19	—	—	L19	—	—	L19	L19
Transmission, Automatic (4 Speed w/overdrive)	MX0	MX0	MX0	MX0	MX0	MX0	MX0	MX0	MX0	MX0
Minimum Axle Ratio (to 1) (Gross Trailer Weight [lbs.]) w/Minimum Engine	3.08	3.42	—	3.08	3.42	—	3.42 (6000)	3.73 (7000)	—	—
	—	—	—	—	—	—	—	4.10 (8000)	—	—
w/5.7L V8 Engine	—	—	4.10	—	—	4.10	3.42 (6500)	3.73 (7500)	4.10 (8500)	4.10 (8500)
	—	—	—	—	—	—	3.73 (7500)	4.10 (9000)	4.56 (10,000)	4.56 (10,000)
w/7.4L V8 Engine	—	—	3.42	—	—	3.42	—	—	3.73 (9500)	3.73 (9500)
	—	—	—	—	—	—	—	—	4.10 (10,000)	4.10 (10,000)
Trailing Special Package	—	—	—	Z82	Z82	Z82	Z82	Z82	Z82	Z82
Bumper, Rear Step Type	V43/VB3	V43/VB3	V43/VB3	—	—	—	—	—	—	—
Cooler, Engine Oil	NR	NR	NR	KC4²	KC4²	KC4²	KC4²	KC4²	KC4²	KC4²
Cooler, Transmission Oil	NR	NR	NR	V02	V02²	V02²	V02²	V02²	V02²	V02²
Cooling, Heavy-Duty	V01	V01	V01	V01	V01	V01	—	—	—	—
Mirrors, Camper Type	NR	NR	NR	DF2	DF2	DF2	DF2	DF2	DF2	DF2
Electronic Speed Control/ Comfortilt Steering	NR	NR	NR	ZQ3	ZQ3	ZQ3	ZQ3	ZQ3	ZQ3	ZQ3

¹ If you order more than the minimum required equipment or carry more than 2 passengers, the additional weight must be subtracted from the maximum trailer weight.

² Included in Trailing Special Package, RPO Z82.

NOTE: Model and driveline combinations must be verified by your local dealer for correct emissions equipment.

NR—Not Required.

WHEEL DRIVE DIESEL POWERED FULL-SIZE PICKUPS

Trailer Classification	Light			Medium			Heavy			
Gross Trailer Weight (lbs.) up to ¹	2000			4000			5000	6000	8000	8000
Maximum Tongue Load (lbs.)	200			400			600	700	1000	1000
Series	C1500	C2500	C3500	C1500	C2500	C3500	C1500	C2500	C2500/C6P	C3500
Engine										
6.2L (379) V8 Diesel	LH6	LH6	LL4	LH6	LH6	LL4	LH6	LH6	LL4	LL4
Transmission, Automatic (4 Speed w/Overdrive)	MX0	MX0	MX0	MX0	MX0	MX0	MX0	MX0	MX0	MX0
Minimum Axle Ratio (to 1) (Gross Trailer Weight [lbs.])	3.08	3.42	4.10	3.42	3.42	4.10	3.42	3.42 (5000)	4.10 (6500)	4.10 (6500)
	—	—	—	—	—	—	—	3.73 (6000)	4.56 (8000)	4.56 (8000)
Trailer Special Package	—	—	—	Z82	Z82	Z82	Z82	Z82	Z82	Z82
Bumper, Rear Step Type	V43/VB3	V43/VB3	V43/VB3	—	—	—	—	—	—	—
Cooler, Engine Oil	Std.	Std.	Std.	Std.	Std.	Std.	Std.	Std.	Std.	Std.
Cooler, Transmission Oil	NR	NR	V02 ²	V02 ²	V02 ²	V02 ²	V02 ²	V02 ²	V02 ²	V02 ²
Cooling, Heavy-Duty	Std.	Std.	Std.	Std.	Std.	Std.	Std.	Std.	Std.	Std.
Mirrors, Camper Type	NR	NR	NR	DF2	DF2	DF2	DF2	DF2	DF2	DF2
Electronic Speed Control/Comfortilt Steering	NR	NR	NR	ZQ3	ZQ3	ZQ3	ZQ3	ZQ3	ZQ3	ZQ3

WHEEL DRIVE GASOLINE POWERED FULL-SIZE PICKUPS

Trailer Classification	Light			Medium			Heavy			
Gross Trailer Weight (lbs.) up to ²	2000			4000			7500	8500	9500	10,000
Maximum Tongue Load (lbs.)	200			400			900	950	1000	1000
Series	K1500	K2500	K3500	K1500	K2500	K3500	K1500	K2500	K2500/C6P	K3500
Minimum Engine										
4.3L (262) V6 EFI	LB4	LB4	—	LB4	LB4	—	—	—	—	—
5.0L (305) V8 EFI	—	—	—	—	—	—	L03	L03	—	—
5.7L (350) V8 EFI	—	—	L05	—	—	L05	L05	L05	L05	L05
7.4L (454) V8 EFI	—	—	L19	—	—	L19	—	—	L19	L19
Transmission, Automatic (4 Speed w/Overdrive)	MX0	MX0	MX0	MX0	MX0	MX0	MX0	MX0	MX0	MX0
Minimum Axle Ratio (to 1) (Gross Trailer Weight [lbs.]) w/Minimum Engine	3.42	3.42	—	3.42	3.42	—	3.42 (6000)	3.42 (5500)	—	—
	—	—	—	—	—	—	3.73 (7000)	3.73 (6500)	—	—
w/5.7L V8 Engine	—	—	4.10	—	—	4.10	3.42 (6500)	3.73 (7000)	4.10 (8000)	4.10 (8000)
	—	—	—	—	—	—	3.73 (7500)	4.10 (8500)	4.56 (9500)	4.56 (9500)
w/7.4L V8 Engine	—	—	3.42	—	—	3.42	—	—	—	3.73 (9000)
	—	—	—	—	—	—	—	—	—	4.10 (10,000)
Trailer Special Package	—	—	—	Z82	Z82	Z82	Z82	Z82	Z82	Z82
Bumper, Rear Step Type	V43/VB3	V43/VB3	V43/VB3	—	—	—	—	—	—	—
Cooler, Engine Oil	NR	NR	NR	KC4 ²	KC4 ²	KC4 ²	KC4 ²	KC4 ²	KC4 ²	KC4 ²
Cooler, Transmission Oil	NR	NR	NR	V02 ²	V02 ²	V02 ²	V02 ²	V02 ²	V02 ²	V02 ²
Cooling, Heavy-Duty	V01	V01	V01	V01	V01	V01	NR	NR	NR	NR
Mirrors, Camper Type	NR	NR	NR	DF2	DF2	DF2	—	—	—	—
Electronic Speed Control/Comfortilt Steering	NR	NR	NR	ZQ3	ZQ3	ZQ3	ZQ3	ZQ3	ZQ3	ZQ3

¹ If you order more than the minimum required equipment or carry more than 2 passengers, the additional weight must be subtracted from the maximum trailer weight.

² Included in Trailer Special Package. RPO Z82.

NOTE: Model and driveline combinations must be verified by your local dealer for correct emissions equipment.

NR—Not Required.

4-WHEEL DRIVE DIESEL-POWERED FULL-SIZE PICKUPS

Trailer Classification	Light			Medium			Heavy			
	2000			4000			6000	6500	8000	7500
Gross Trailer Weight (lbs.) up to ¹	2000			4000			6000	6500	8000	7500
Maximum Tongue Load (lbs.)	200			400			750	750	950	900
Series	K1500	K2500	K3500	K1500	K2500	K3500	K1500	K2500	K2500/C6P	K3500
Engine										
6.2L (379) V8 Diesel	LH6	LH6	LL4	LH6	LH6	LL4	LH6	LH6	LL4	LL4
Transmission, Automatic (4 Speed w/Overdrive)	MX0	MX0	MX0	MX0	MX0	MX0	MX0	MX0	MX0	MX0
Minimum Axle Ratio (to 1) (Gross Trailer Weight [lbs.])	3.42	3.42	4.10	3.42	3.42	4.10	3.42	3.73	4.10	4.10
	—	—	—	—	—	—	(5000) 3.73	(5500) 4.10	(6500) 4.56	(6000) 4.56
Trailer Special Package	—	—	—	Z82	Z82	Z82	Z82	Z82	Z82	Z82
Bumper, Rear Step Type ²	V43/VB3	V43/VB3	V43/VB3	—	—	—	—	—	—	—
Cooler, Engine Oil	Std.	Std.	Std.	Std.	Std.	Std.	Std.	Std.	Std.	Std.
Cooler, Transmission Oil	NR	NR	NR	V02 ²	V02 ²	V02 ²	V02 ²	V02 ²	V02 ²	V02 ²
Cooling, Heavy-Duty	Std.	Std.	Std.	Std.	Std.	Std.	Std.	Std.	Std.	Std.
Mirrors, Camper Type	NR	NR	NR	DF2	DF2	DF2	DF2	DF2	DF2	DF2
Electronic Speed Control/ Comfortilt Steering	NR	NR	NR	ZQ3	ZQ3	ZQ3	ZQ3	ZQ3	ZQ3	ZQ3

¹ If you order more than the minimum required equipment or carry more than 2 passengers, the additional weight must be subtracted from the maximum trailer weight.
² Included in Trailering Special Package, RPO Z82.

NOTE: Model and driveline combinations must be verified by your local dealer for correct emissions equipment.

NR—Not Required.

2-WHEEL DRIVE AND 4-WHEEL DRIVE GASOLINE-POWERED FULL-SIZE PICKUPS FIFTH WHEEL WITH KINGPIN-TYPE HITCH

Trailer Classification	Heavy		Heavy		Heavy		Heavy	
	8000	9000	10,000	14,000	7500	8500	9500	13,500
Gross Trailer Weight (lbs.) up to ¹	8000	9000	10,000	14,000	7500	8500	9500	13,500
Series	C2500		C2500/C6P	C3500	K2500	K2500/C6P	K3500	
Minimum Engine								
5.0L (305) V8 EFI	L03	—	—	—	L03	—	—	—
5.7L (350) V8 EFI	—	L05	L05	L05	—	L05	L05	L05
7.4L (454) V8 EFI	—	—	L19	L19	—	L19	—	L19
Maximum GVWR (lbs.)	7200	7200	8600	10,000	7200	7200	8600	10,000
Transmission, Automatic ² (4 Speed w/Overdrive)	MX0	MX0	MX0	MX0	MX0	MX0	MX0	MX0
Minimum Axle Ratio (to 1) (Gross Trailer Weight [lbs.])	3.73	3.42	3.73	3.42	3.42	3.42	3.73	3.42
	(7000)	(6500)	(7000)	(8500)	(5500)	(6000)	(6500)	(8000)
	4.10	3.73	4.10	3.73	3.73	3.73	4.10	3.73
	(8000)	(7500)	(8500)	(9500)	(6500)	(7000)	(8000)	(9000)
	—	4.10	4.56	4.10	4.10	4.10	4.56	4.10
		(9000)	(10,000)	(11,000)	(7500)	(8500)	(9500)	(10,500)
	—	—	—	4.56	—	—	—	4.56
				(14,000)				(13,500)
Cooler, Engine Oil	KC4	KC4	KC4	KC4	KC4	KC4	KC4	KC4
Cooler, Transmission Oil	V02	V02	V02	V02	V02	V02	V02	V02
Cooling, Heavy-Duty	NR	NR	NR	NR	NR	NR	NR	NR
Mirrors, Camper Type	DF2	DF2	DF2	DF2	DF2	DF2	DF2	DF2
Electronic Speed Control/ Comfortilt Steering	ZQ3	ZQ3	ZQ3	ZQ3	ZQ3	ZQ3	ZQ3	ZQ3

¹ If you order more than the minimum required equipment or carry more than 2 passengers, the additional weight must be subtracted from the maximum trailer weight.
² Manual transmission, RPO MM4, may be used on any 3500 model (heavy-duty radiator, RPO V01, required).

NOTE: Model and driveline combinations must be verified by your local dealer for correct emissions equipment.

NR—Not Required.

**2-WHEEL DRIVE AND 4-WHEEL DRIVE DIESEL-POWERED
FULL-SIZE PICKUPS—FIFTH WHEEL WITH KINGPIN-TYPE HITCH**

Trailer Classification	Heavy	Heavy	Heavy	Heavy	Heavy	Heavy
Gross Trailer Weight (lbs.) up to ¹	6000	8000	8000	6500	7500	7500
Series	C2500	C2500/C6P	C3500	K2500	K2500/C6P	K3500
Engine						
6.2L (379) V8 Diesel	LH6	LL4	LL4	LH6	LL4	LL4
Maximum GVWR (lbs.)	7200	8600	10,000	7200	8600	10,000
Transmission, Automatic ² (4 Speed w/Overdrive)	MX0	MX0	MX0	MX0	MX0	MX0
Minimum Axle Ratio (to 1) (Gross Trailer Weight [lbs.])	3.42 (5000)	3.73 (5500)	4.10 (6500)	3.42 (4500)	3.73 (5000)	4.10 (6000)
	3.73 (6000)	4.10 (6500)	4.56 (8000)	3.73 (5500)	4.10 (6000)	4.56 (7500)
	—	4.56 (8000)	—	4.10 (6500)	4.56 (7500)	—
Cooler, Engine Oil	Std.	Std.	Std.	Std.	Std.	Std.
Cooler, Transmission Oil	V02	V02	V02	V02	V02	V02
Cooling, Heavy-Duty	Std.	Std.	Std.	Std.	Std.	Std.
Mirrors, Camper Type	DF2	DF2	DF2	DF2	DF2	DF2
Electronic Speed Control/ Comfortilt Steering	ZQ3	ZQ3	ZQ3	ZQ3	ZQ3	ZQ3

**COMMERCIAL 2-WHEEL DRIVE AND 4-WHEEL DRIVE GASOLINE
AND DIESEL-POWERED FULL-SIZE PICKUPS—CONVENTIONAL TRAILER**

Trailer Classification	C/K REGULAR CAB		C/K REGULAR CAB	
	Heavy		Heavy	
Gross Trailer Weight (lbs.) up to ¹	10,000	10,000	9000	8500
Maximum Tongue Load (lbs.)	1000	1000	1000	950
Series	C3500	K3500	C3500	K3500
Minimum Engine				
5.7L (350) V8 EFI	L05	L05	—	—
7.4L (454) V8 EFI	L19	L19	—	—
6.2L (379) V8 Diesel	—	—	LL4	LL4
Transmission, Automatic (4 Speed w/Overdrive)	MX0	MX0	MX0	MX0
Minimum Axle Ratio (to 1) (Gross Trailer Weight [lbs.]) w/5.7L V8 Engine	4.10 (8500)	4.10 (8000)	—	—
	4.56 (10,000)	4.56 (9500)	—	—
	3.42 (8500)	3.42 (8000)	—	—
w/7.4L V8 Engine	3.73 (9500)	3.73 (9000)	—	—
	4.10/4.56 (10,000)	4.10/4.56 (10,000)	—	—
	—	—	4.10 (7500)	4.10 (7000)
w/6.2L V8 Diesel	—	—	4.56 (9000)	4.56 (8500)
Trailering Special Package	Z82	Z82	Z82	Z82
Minimum Tire Size	Std.	Std.	Std.	Std.
Carrier, Spare Wheel Side Mounted	—	—	—	—
Cooler, Engine Oil	KC4	KC4	KC4	KC4
Cooler, Transmission Oil	V02 ³	V02 ³	V02 ³	V02 ³
Cooling, Heavy-Duty	—	—	Std.	Std.
Mirrors, Camper Type	DF2	DF2	DF2	DF2
Stabilizer Bar, Front, Heavy-Duty	Std.	Std.	Std.	Std.

¹If you order more than the minimum required equipment or carry more than 2 passengers, the additional weight must be subtracted from the maximum trailer weight.

²Manual transmission, RPO MM4, may be used on any 3500 model (heavy-duty radiator, RPO V01, required.)

³Included in Trailering Special Package Z82.

NOTE: Model and driveline combinations must be verified by your local dealer for correct emissions equipment.

NR—Not Required.

2-WHEEL DRIVE AND 4-WHEEL DRIVE GASOLINE AND DIESEL POWERED FULL SIZE PICKUPS—5TH WHEEL TRAILERING

Trailer Classification	C/K REGULAR CAB		C/K REGULAR CAB	
	Heavy		Heavy	
Gross Trailer Weight (lbs.) up to ¹	14,000	13,500	8000	7500
Series	C3500	K3500	C3500	K3500
Minimum Engine				
5.7L (350) V8 EFI	L05	L05	—	—
7.4L (454) V8 EFI	L19	L19	—	—
6.2L (379) V8 Diesel	—	—	LL4	LL4
Maximum GVWR (lbs)	10,000	10,000	10,000	10,000
Transmission, Automatic ² (4 Speed w/Overdrive)	MX0	MX0	MX0	MX0
Minimum Axle Ratio (to 1) (Gross Trailer Weight [lbs.]) w/5.7L V8 Engine	4.10 (8500)	4.10 (8000)	—	—
	4.56 (10,000)	4.56 (10,000)	—	—
w/7.4L V8 Engine	4.10 (11,000)	4.10 (10,500)	—	—
	4.56² (14,000)	4.56² (13,500)	—	—
w/6.2L V8 Diesel	—	—	4.10 (8000)	4.10 (7500)
Minimum Tire Size	Std.	Std.	Std.	Std.
Cooler, Engine Oil	KC4	KC4	Std.	Std.
Cooler, Transmission Oil ⁴	V02	V02	V02	V02
Cooling, Heavy-Duty	V01	V01	Std.	Std.
Mirrors, Camper Type	DF2	DF2	DF2	DF2
Stabilizer Bar, Front, Heavy-Duty	Std.	Std.	Std.	Std.

¹ If you order more than the minimum required equipment or carry more than 2 passengers, the additional weight must be subtracted from the maximum trailer weight.

² Manual transmission can also be specified.

NOTE 1: Maximum Gross Combination Weight (GCWR) for fifth-wheel commercial trailering is 18,000-lbs. with gasoline engines and 15,000-lbs. with diesel engines.

NOTE 2: Model and driveline combinations must be verified by your local dealer for correct emissions equipment.

HOW TO USE GCWRs TO DETERMINE POWERTRAIN AND REAR AXLE RATIO FOR TRAILERING

Perhaps you prefer to use Gross Combination Weight Ratings (GCWRs) to determine the engine, transmission and rear axle ratio you will require to tow a trailer with your truck. The chart below allows you to do just that. It shows you the maximum allowable GCWR based on all the available truck engines and rear

axle ratios with automatic or manual transmissions. **The GCWR includes the total loaded weight of both the truck and trailer.** Any available engine may be used for trailering if the GCWR shown is not exceeded. The trailer weight can be increased by 25% if the vehicle speed will not exceed 25 mph.

GROSS COMBINATION WEIGHT RATING (GCWR) By Engine & Axle Ratio For Recreational Applications																				
With Automatic Transmission																				
GCWR (lb.)	6000	6500	7000	7500	8000	8500	9000	9500	10,000	10,500	11,000	11,500	12,000	12,500	13,500	14,000	14,500	15,000	16,000	19,000
Engines	Rear Axle Ratios																			
4.3L (262) V6 Gas				2.73		3.08	3.23	3.42	3.73	4.10/ 4.11	4.56									
5.0L (305) V8 Gas						2.73		3.08		3.42		3.73		4.10						
5.7L (350) V8 Gas							2.73		3.08	3.23	3.42		3.73		4.10			4.56		
6.2L (379) V8 Diesel								3.08	3.23	3.42		3.73		4.10		4.56	5.13			
7.4L (454) V8 Gas															3.42		3.73		4.10	4.56
With Manual Transmission																				
GCWR (lb.)	5000	5500	6000	6500	7000	8000	8500	9000	9500	10,000	11,000	12,000	13,500	14,500	15,000	16,000	19,000			
Engines	Rear Axle Ratios																			
4.3L (262) V6 Gas				2.73	3.08	3.42	3.73													
5.0L (305) V8 Gas						3.08	3.42		3.73											
5.7L (350) V8 Gas												3.08	3.42	3.73	4.10		4.56			
6.2L (379) V8 Diesel						3.08	3.42		3.73		4.10	4.56								
7.4L (454) V8 Gas														3.42	3.73		4.10	4.56		

Note: Model and driveline combinations must be verified by your local dealer for correct emissions equipment.

GENERAL TRAILERING INFORMATION

AVAILABLE TRAILERING EQUIPMENT

Chevrolet offers a wide selection of available options for trailering and a few of them are described here.

LIGHT-DUTY TRAILER HITCH

For hauling trailers up to 2000-lbs. with a maximum tongue load of 200-lbs. A 1 7/8"-diameter ball is included. (Dealer-installed accessory. See chart for part numbers.)

HITCH BALLS

1 7/8"-diameter ball is standard with light-duty hitches. It is also available as an accessory: Part No. 981148. A 2"-diameter ball is also available for hitches as Part No. 980670.

LOAD-DISTRIBUTING PLATFORM

Required when towing trailers over 2000-lbs. Installs quickly and easily. (Dealer-installed accessory. See chart for part numbers.)

WIRING HARNESSSES

5-wire used with trailers over 2000-lbs. gross weight and 7-wire for larger trailers. Harnesses tie into vehicle's electrical system to give your trailer lights, plus electric brakes or battery charging.

TRUCK WIRING CODE

The following color code for trucks should be used when installing trailer wiring harnesses.

- **Blue.** Used for electric trailer brakes or auxiliary wiring.
- **Red.** Used for battery charging. Connects to starter solenoid. (7-wire harness only).
- **Light Green.** Backup lights (7-wire harness only).
- **Brown.** Taillight and running lights.
- **Yellow.** Left stop and turn signal.
- **Dark Green.** Right stop and turn signal.
- **White.** Ground.

MIRRORS

Trucks used as tow vehicles will require outside mirrors with extensions that exceed the width of the trailer to be towed. Optional mirrors with larger mounting brackets are available with all truck models.

COOLERS AND COOLING

Trailering creates higher-than-normal temperatures in coolant, engine and transmission oil. To help control these temperatures, consider the following separate options.

RPO V02. This is an extra-capacity heavy-duty automatic transmission oil cooler option. (Included in RPO Z82 Special Trailering Package.)

RPO KC4. This optional engine oil cooler circulates oil through a separate cooler mounted ahead of the radiator. (Included in RPO Z82 Special Trailering Package.)

DEALER-INSTALLED TRAILER HITCHES

	Light Up to 2000-Lbs. 200-Lb. Tongue Load	Light/Medium Up to 4000-Lbs. 400-Lb. Tongue Load	Heavy Up to 6000-Lbs. 750-Lb. Tongue Load	Heavy Up to 7000-Lbs. 850-Lb. Tongue Load
Type of Hitch	Deadweight ¹	Rear Step Bumper ²	Weight-Distrib. Platform	Weight-Distrib. Platform
C/K Pickup (Long wheelbase only)		999862-Painted 999863-Chromed	—	999772 ²

¹ Deadweight hitch includes 1 7/8 ball. ² Requires a rear bumper. Not available with underframe space tire carrier.

³ 1 7/8" ball for step-type bumper—Part No. 998392. 2" ball for step-bumper—Part No. 980670

NOTE: If the vehicle is equipped with a step bumper, the "V" shaped foot on the trailer tongue could dent the step bumper in a sharp turn. Before towing a trailer with a vehicle equipped with a step bumper, check the distance from the trailer foot front edge to the center of the couple ball socket. If this dimension is less than 12 inches, remove the foot on the trailer tongue or possible damage to the step bumper could occur.

SOLID COLOR

(ZY1)

WT 1500 WORK TRUCK

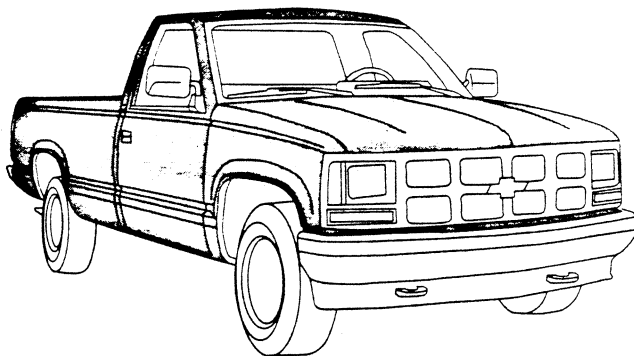

Solid color paint (ZY1) is standard on the WT 1500 Work Truck. All Painted areas of the cab, front end sheet metal, and box are the same color. The only available Color Code 1/Color Code 2 exterior paint combinations are those displayed in the chart below. Recommended interior trim colors are indicated by the symbol ●. For more information, refer to Seats and Interior Trim pages as well as the Truck Order Guide.

KEY: ●—Recommended

EXTERIOR COLORS		STRIPE COLORS	INTERIOR COLORS				
COLOR CODE 1	COLOR CODE 2		Beige	Blue	Garnet	Gray	Saddle
27 Smoke Blue Met.	27 Smoke Blue Metallic	—		●		●	
50 Summit White	50 Summit White	—	●	●	●	●	●
70 Flame Red Met.	70 Flame Red Metallic	—			●	●	●
96 Quicksilver Met.	96 Quicksilver Metallic	—		●	●	●	

CONVENTIONAL TWO-TONE

(ZY2)

Convention two-tone (ZY2) paint colors are available on all models. Color code 1 is applied to the areas above the lower styling crease line (including the cab roof). Color code 2 is applied to the areas below. Outlined block "Chevrolet" decal lettering is applied to the tailgate. (A bright trim plate with lettering is applied on Fleetside models when the Silverado trim is ordered). The only available Color Code 1/Color Code 2 exterior paint combinations are those displayed in the chart below. Recommended interior trim colors are indicated by the symbol ●. For more information, refer to Seats and Interior Trim pages as well as the Truck Order Guide.

Color Code 1

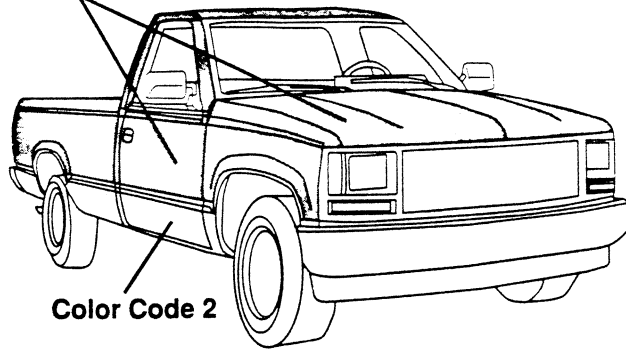

Color Code 2

KEY: ●—Recommended ●—Not Available on C/K Extended Cab

Bold type —Not Available on K3500 Models or K2500 Models w/C6P

EXTERIOR COLORS		STRIPE COLORS	INTERIOR COLORS				
COLOR CODE 1	COLOR CODE 2	w/D 85	Beige	Blue	Garnet	Gray	Saddle
22 Brilliant Blue Metallic	50 Summit White	Lt. Blue		●			
	96 Quicksilver Metallic	Silver		●			
	97 Slate Metallic	Lt. Blue		●			
27 Smoke Blue Metallic	30 Catalina Blue Metallic	Lt. Blue		●			
	41 Onyx Black	Lt. Blue		●			
	41 Onyx Black	Silver				●	
	50 Summit White	Silver				●	
30 Catalina Blue Metallic	50 Summit White	Lt. Blue		●			
	27 Smoke Blue Metallic	Lt. Blue		●			
	50 Summit White	Lt. Blue		●			
41 Onyx Black	96 Quicksilver Metallic	Silver		●			
	50 Summit White	Silver				●	
	58 Sandstone Metallic	Lt. Beige	●				
	70 Flame Red	Vermillion			●		●
	96 Quicksilver Metallic	Silver				●	
50 Summit White	97 Slate Metallic	Vermillion			●		
	97 Slate Metallic	Silver				●	
	22 Brilliant Blue Metallic	Lt. Blue		●			
	27 Smoke Blue Metallic	Lt. Blue		●			
	30 Catalina Blue Metallic	Lt. Blue		●			
	41 Onyx Black	Gold					●
	41 Onyx Black	Silver				●	
	41 Onyx Black	Vermillion			●		
	70 Flame Red	Vermillion			●		
94 Crimson Red Metallic	Vermillion			●			
97 Slate Metallic	Vermillion			●			
97 Slate Metallic	Silver				●		
58 Sandstone	41 Onyx Black	Dark Brown	●				
	94 Crimson Red Metallic	Vermillion	●				
	97 Slate Metallic	Vermillion	●				
70 Flame Red	41 Onyx Black	Vermillion			●		
	41 Onyx Black	Silver				●	
	50 Summit White	Vermillion			●		
	50 Summit White	Silver				●	
	96 Quicksilver Metallic	Silver			●		●
	97 Slate Metallic	Vermillion			●		
	97 Slate Metallic	Silver				●	
94 Crimson Red Metallic	41 Onyx Black	Silver				●	
	41 Onyx Black	Vermillion			●		
	50 Summit White	Vermillion			●		
	58 Sandstone Metallic	Lt. Beige	●		●		
	96 Quicksilver Metallic	Silver			●		●
96 Quicksilver	22 Brilliant Blue Metallic	Lt. Blue		●			
	30 Catalina Blue Metallic	Lt. Blue		●			
	41 Onyx Black	Vermillion			●		●
	70 Flame Red	Vermillion			●		●
	94 Crimson Red Metallic	Vermillion			●		●
	97 Slate Metallic	Vermillion			●		●
97 Slate Metallic	41 Onyx Black	Vermillion			●		
	41 Onyx Black	Silver				●	
	50 Summit White	Vermillion			●		
	50 Summit White	Silver				●	
	58 Sandstone Metallic	Vermillion	●				
	70 Flame Red	Vermillion			●		
	70 Flame Red	Silver				●	
	96 Quicksilver Metallic	Vermillion			●		
	96 Quicksilver Metallic	Silver				●	

SPECIAL TWO-TONE (ZY3)

Special two-tone (ZY3) paint colors are available only on Fleetside pickup models and include a multi-stripe decal applied over the paint break at the beltline. Color Code 1 is applied to the areas above the decal (including the cab roof). Color Code 2 is applied to the areas below. Outlined block "Chevrolet" decal lettering is applied to the tailgate. (A bright trim plate with lettering is applied on Fleetside models when the Silverado trim is ordered.) The only available Color Code 1/Color Code 2 exterior paint combinations are those displayed in the chart below. Recommended interior trim colors are indicated by the symbol ●. For more information, refer to Seats and Interior Trim pages as well as the Truck Order Guide.

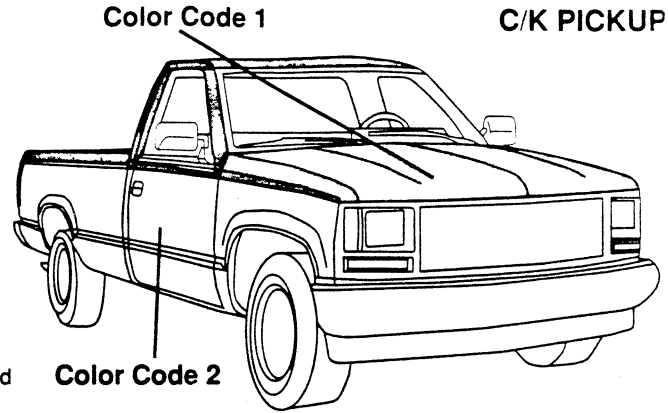

KEY: ●—Recommended ●—Not Available on C/K Extended Cab **Bold type**—Not Available on K3500 Models or K2500 Models w/C6P.

EXTERIOR COLORS		STRIPE COLORS	INTERIOR COLORS			
COLOR CODE 1	COLOR CODE 2		Beige	Blue	Garnet	Gray
22 Brilliant Blue Metallic	50 Summit White	Lt. Blue/Dk. Blue		●		
	96 Quicksilver Metallic	Lt. Blue/Slate		●		
	97 Slate Metallic	Lt. Blue/Slate		●		
27 Smoke Blue Metallic	30 Catalina Blue	Lt. Blue/Dk. Blue		●		
	41 Onyx Black	Lt. Blue/Dk. Blue		●		
	41 Onyx Black	Dk. Blue/Slate				●
	50 Summit White	Lt. Blue/Slate		●		●
30 Catalina Blue Metallic	27 Smoke Blue Metallic	Lt. Blue/Dk. Blue		●		
	50 Summit White	Lt. Blue/Dk. Blue		●		
	96 Quicksilver Metallic	Lt. Blue/Dk. Blue		●		●
41 Onyx Black	50 Summit White	Vermillion/Silver				●
	58 Sandstone Metallic	Gold/Black	●			●
	70 Flame Red	Vermillion/Garnet			●	
	70 Flame Red	Vermillion/Silver				●
	94 Crimson Red Metallic	Vermillion/Garnet			●	
	96 Quicksilver Metallic	Vermillion/Silver				●
	97 Slate Metallic	Vermillion/Silver			●	●
50 Summit White	22 Brilliant Blue Metallic	Lt. Blue/Dk. Blue		●		
	27 Smoke Blue Metallic	Lt. Blue/Dk. Blue		●		
	30 Catalina Blue Metallic	Lt. Blue/Dk. Blue		●		
	41 Onyx Black	Vermillion/Garnet			●	
	41 Onyx Black	Vermillion/Silver				●
	70 Flame Red	Vermillion/Garnet			●	
	94 Crimson Red Metallic	Vermillion/Garnet			●	
	97 Slate Metallic	Vermillion/Silver			●	●
58 Sandstone Metallic	41 Onyx Black	Dk. Brown/Black	●			
	94 Crimson Red Metallic	Black/Lt. Sandstone	●			
	97 Slate Metallic	Bt. Orange/Lt. Sandstone	●			
70 Flame Red	41 Onyx Black	Vermillion/Garnet			●	
	41 Onyx Black	Vermillion/Silver				●
	50 Summit White	Vermillion/Garnet			●	
	50 Summit White	Vermillion/Silver				●
	96 Quicksilver Met.	Vermillion/Silver			●	●
	97 Slate Metallic	Vermillion/Garnet			●	
94 Crimson Red Metallic	97 Slate Metallic	Vermillion/Silver			●	●
	41 Onyx Black	Gold/Black			●	
	50 Summit White	Vermillion/Garnet			●	
	58 Sandstone Metallic	Vermillion/Garnet			●	
	96 Quicksilver Metallic	Vermillion/Garnet			●	
96 Quicksilver	96 Quicksilver Metallic	Vermillion/Silver				●
	22 Brilliant Blue Metallic	Lt. Blue/Slate		●		
	30 Catalina Blue Metallic	Lt. Blue/Dk. Blue		●		●
	41 Onyx Black	Vermillion/Garnet			●	
	41 Onyx Black	Vermillion/Silver				●
	70 Flame Red	Vermillion/Garnet			●	
	70 Flame Red	Vermillion/Silver				●
	94 Crimson Red Metallic	Vermillion/Garnet			●	
	94 Crimson Red Metallic	Vermillion/Silver				●
	97 Slate Metallic	Vermillion/Silver			●	●
97 Slate Metallic	41 Onyx Black	Vermillion/Silver			●	●
	58 Sandstone Metallic	Bt. Orange/Lt. Sandstone	●			
	58 Summit White	Vermillion/Silver			●	●
	70 Flame Red	Vermillion/Silver			●	●
	96 Quicksilver Metallic	Vermillion/Silver			●	●

DELUXE TWO-TONE

(ZY4)

Deluxe two-tone (ZY4) paint colors are available on Fleetside Pickup models and include the beltline decal described in Special two-tone. The cab roof, hood and pickup box above the beltline decal, as well as the area below the lower styling crease line are painted Color Code 1. The areas between the decal and the lower crease line are painted Color Code 2. Outlined block "Chevrolet" decal lettering is applied to the tailgate. (A bright trim plate with lettering is applied on Fleetside models when the Silverado trim is ordered). The only available Color Code 1/Color Code 2 exterior paint combinations are those displayed in the chart below. Recommended interior trim colors are indicated by the symbol ●. For more information, refer to Seats and Interior Trim pages as well as the Truck Order Guide.

Color Code 1

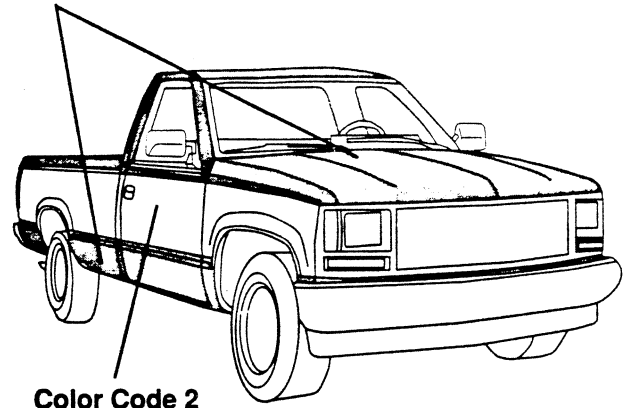

Color Code 2

KEY: ●—Recommended ●—Not Available on C/K Extended Cab **Bold type** —Not Available on K3500 Models or K2500 Models w/C6P

EXTERIOR COLORS		STRIPE COLORS	INTERIOR COLORS			
COLOR CODE 1	COLOR CODE 2		Beige	Blue	Garnet	Gray
22 Brilliant Blue Met.	50 Summit White	Lt. Blue/Dk. Blue		●		
	96 Quicksilver Metallic	Lt. Blue/Slate		●		
	97 Slate Metallic	Lt. Blue/Slate		●		
27 Smoke Blue Met.	30 Catalina Blue	Lt. Blue/Dk. Blue		●		
	41 Onyx Black	Lt. Blue/Dk. Blue		●		
	41 Onyx Black	Dk. Blue/Slate				●
30 Catalina Blue Met.	50 Summit White	Lt. Blue/Slate		●		●
	27 Smoke Blue Metallic	Lt. Blue/Dk. Blue		●		
	96 Quicksilver Metallic	Lt. Blue/Dk. Blue		●		●
41 Onyx Black	50 Summit White	Vermillion/Silver				●
	58 Sandstone Metallic	Gold/Black	●			
	70 Flame Red	Vermillion/Garnet			●	
	70 Flame Red	Vermillion/Silver				●
	94 Crimson Red Metallic	Vermillion/Garnet			●	
	96 Quicksilver Metallic	Vermillion/Silver				●
	97 Slate Metallic	Vermillion/Silver			●	●
50 Summit White	22 Brilliant Blue Metallic	Lt. Blue/Dk. Blue		●		
	27 Smoke Blue	Lt. Blue/Dk. Blue		●		
	30 Catalina Blue Metallic	Lt. Blue/Dk. Blue		●		
	41 Onyx Black	Vermillion/Garnet			●	
	41 Onyx Black	Vermillion/Silver				●
	70 Flame Red	Vermillion/Garnet			●	
	94 Crimson Red Metallic	Vermillion/Garnet			●	
58 Sandstone Metallic	41 Onyx Black	Dk. Brown/Black	●			
	94 Crimson Red Metallic	Black/Lt. Sandstone	●			
	97 Slate Metallic	Bt. Orange/Lt. Sandstone	●			
70 Flame Red	41 Onyx Black	Vermillion/Garnet			●	
	41 Onyx Black	Vermillion/Silver				●
	50 Summit White	Vermillion/Garnet			●	
	50 Summit White	Vermillion/Silver				●
	96 Quicksilver Metallic	Vermillion/Silver			●	●
	97 Slate Metallic	Vermillion/Garnet			●	
	97 Slate Metallic	Vermillion/Silver				●
94 Crimson Red Met.	41 Onyx Black	Gold/Black			●	
	50 Summit White	Vermillion/Garnet			●	
	58 Sandstone Metallic	Vermillion/Garnet			●	
	96 Quicksilver Metallic	Vermillion/Garnet			●	
	96 Quicksilver Metallic	Vermillion/Silver				●
96 Quicksilver Met.	22 Brilliant Blue Metallic	Lt. Blue/Slate		●		
	30 Catalina Blue Metallic	Lt. Blue/Dk. Blue		●		●
	41 Onyx Black	Vermillion/Garnet			●	
	41 Onyx Black	Vermillion/Silver				●
	70 Flame Red	Vermillion/Garnet			●	
	70 Flame Red	Vermillion/Silver				●
	94 Crimson Red Metallic	Vermillion/Garnet			●	
	94 Crimson Red Metallic	Vermillion/Silver				●
	97 Slate Metallic	Vermillion/Silver			●	●
	97 Slate Metallic	Vermillion/Silver			●	●
97 Slate Metallic	41 Onyx Black	Vermillion/Silver			●	●
	58 Sandstone Metallic	Bt. Orange/Lt. Sandstone	●			
	58 Summit White	Vermillion/Silver			●	●
	70 Flame Red	Vermillion/Silver			●	●
	96 Quicksilver Metallic	Vermillion/Silver			●	●

1991 GENERAL MOTORS CORPORATION

INFORMATION REGARDING

CONSUMER INFORMATION TRUCK-CAMPER LOADING

PUBLISHED SEPTEMBER 1989

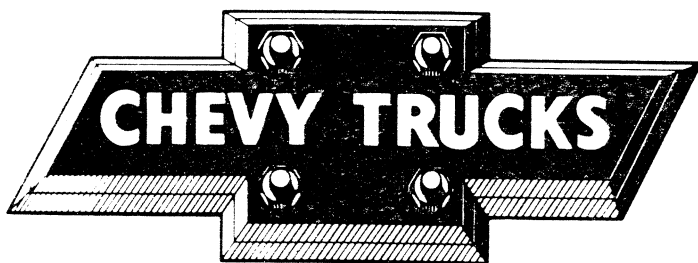

CHEVROLET MOTOR DIVISION
30007 VAN DYKE AVENUE
WARREN, MICHIGAN 48090



GMC TRUCK DIVISION
31 JUDSON STREET
PONTIAC, MICHIGAN 48058

1991 GENERAL MOTORS TRUCKS

Consumer Information Truck – Camper Loading

CONSUMER INFORMATION REGULATION 575.103 issued by the National Highway Traffic Safety Administration requires manufacturers of trucks capable of accommodating slide-in camper bodies to provide information concerning proper load and proper load distribution in truck-camper applications.

This Consumer Information booklet is designed to provide basic information relating to load capabilities of 1991 General Motors Truck models which are adaptable to slide-in camper applications. Information contained herein is applicable to the truck buyer that already owns a 1991 General Motors Truck or the prospective truck purchaser.

The Regulation also provides that proper truck-camper loading information is to be maintained in truck dealerships and be made available to all prospects on request. This booklet relates to the 1991 General Motors Truck models recommended for slide-in camper applications and is to be used as a consumer information piece.

Product specifications or data contained herein may change periodically. When a revision of this booklet is supplied to truck dealers, it is the dealers' responsibility to make the revised information available to the public.

All illustrations and specifications contained in this literature are based on the latest product information available at the time of publication approval. The right is reserved to make changes at any time in prices, colors, materials, equipment, specifications and models, and also to discontinue models.

TRUCK – CAMPER LOADING

Consumer Information Regulation 575.103 requires manufacturers of trucks capable of accommodating slide-in campers to specify the vehicles' Cargo Weight Rating (CWR) and the longitudinal limits within which the center of gravity for the cargo weight rating should be located.

Cargo Weight Rating (CWR)—The cargo weight rating of a vehicle means the value specified by the vehicle manufacturer as the cargo-carrying capacity of a vehicle in pounds, exclusive of (minus) the weight of occupants, computed as 150 pounds times the number of designated seating positions.

Longitudinal Center of Gravity Zone for CWR (CG)—The forward limit of the recommended CG Zone is determined by the application of dimension "A" measured in inches from the rear of the truck bed. The rearward limit of the recommended CG Zone is established by application of dimension "B", also measured in inches from the rear of the truck bed. The recommended CG Zone lies between these points.

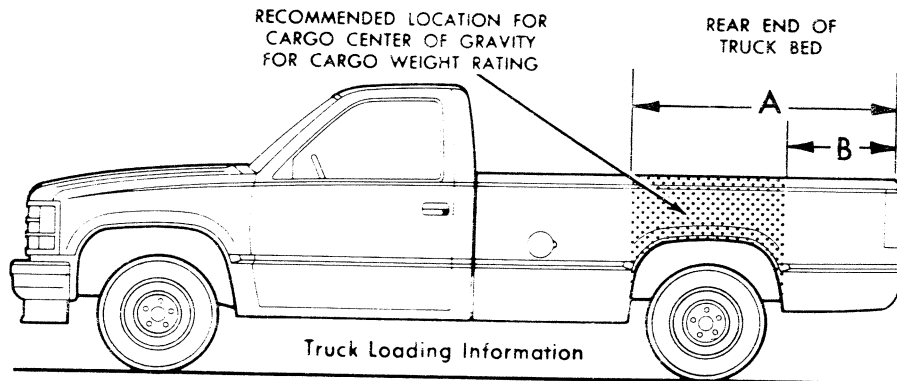

Model _____ Calculated Cargo Weight Rating _____
 Dimension A _____ Dimension B _____

Limitations on Recommended CG Zones

FORWARD LIMIT

- (1) Must not extend beyond the inside surface of the pickup box. (2) Must not exceed the front gross axle weight rating (GAWR).

REARWARD LIMIT

- (1) Must be no farther rearward than the inside surface of the pickup box. (2) Must not exceed the gross axle weight rating (GAWR) on the rear axle.
 (2) Must not exceed the gross axle weight below: (3) Must not exceed rear axle load limits below:

Series	Rear Axle Load Limits (% of GVWR)
S/T-10/15	62%
C/K 1500	60%
C/K 2500	65%
C/K 2500/C6P, C/K 3500	70%
R/V 3500	70%

Vehicle (CG) Identification—All General Motors Corporation trucks that may be suitable for carrying a slide-in camper incorporate a Truck-Camper Loading information label located on the inside of the glove box door on C/K and R/V models, or on the trailing edge of the driver's door on S/T-10/15 models. The vehicle identification number (VIN), the as-manufactured cargo weight rating (CWR) of that vehicle plus the CG limits of dimension "A" and "B" for that vehicle in inches are included.

Vehicle and Truck-Camper Loading are also discussed at length in the first few pages of the Vehicle Owner's Manual.

TRUCK – CAMPER LOADING

Loading Instructions – When the truck is used to carry a slide-in camper, the total cargo load of the truck consists of the camper manufacturer's weight figure, the weight of installed additional camper equipment not included in the camper manufacturer's weight figure, the weight of camper cargo and the weight of passengers *in the camper*. The total cargo load should not exceed the truck's cargo weight rating (CWR) and the camper's center of gravity should fall within the truck's recommended center of gravity zone when installed.

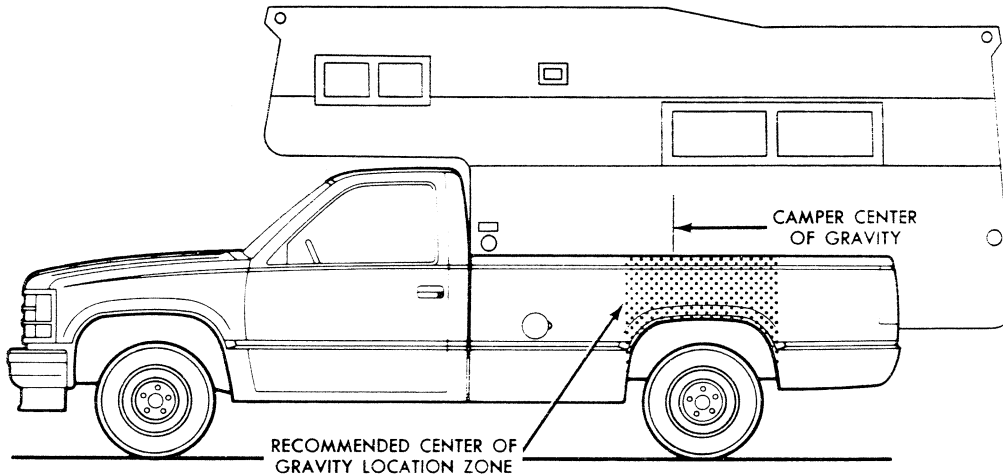

Any accessories or other equipment added to this vehicle, after final date of manufacture, must be weighed or have their weight determined, and the weight deducted from the prescribed cargo weight rating (CWR) of this vehicle. This may decrease the permissible longitudinal zone of the center of gravity for this vehicle.

The longitudinal center of gravity zone has been determined for the full cargo weight rating of this truck. If a slide-in camper has a total weight less than the cargo weight rating (CWR), the permissible longitudinal zone of the center of gravity may be larger. However, individual axle loads should not exceed either of the gross axle weight ratings (GAWR).

Secure loose items to prevent weight shifts that could affect the balance of your vehicle. When the truck camper is loaded, drive to a scale and weigh the front and the rear separately to determine the axle loads. Individual axle loads should not exceed either of the gross axle weight ratings (GAWR). The total of the axle loads should not exceed the gross vehicle weight rating (GVWR). These ratings are given on the vehicle identification plate and on the vehicle certification label which are located on the left side of the vehicle, normally on the door latch post or door edge next to the driver. If weight ratings are exceeded, move or remove items to bring all weights below the ratings.

CAUTION: The longitudinal center of gravity is only one of the many factors which may affect the overall performance of a vehicle, including handling, steering and braking. The cargo load should be distributed on both sides of the centerline as equally as possible. The recommended, longitudinal limits for the camper's center of gravity are based on the assumption that the vehicle will be operated with reasonable prudence in light of all of the existing conditions. Failure to do so could result in unsatisfactory vehicle performance and could make the vehicle unsafe to operate.

In this connection, refer to any recommendations by the slide-in camper manufacturer regarding installation and loading of the camper.

TRUCK – CAMPER LOADING

DEFINITION OF TERMS

For the purposes of calculating Truck-Camper Loading in this book, listed below are some common terms and abbreviations:

Cargo Weight Rating (CWR)— means the value specified by the vehicle manufacturer as the cargo-carrying capacity of a vehicle in pounds, exclusive of (minus) the weight of occupants, computed as 150 pounds times the number of designated seating positions.

Center of Gravity (CG)—Point where the mass of a body is concentrated and if suspended at that point would balance front and rear.

Curb Weight—Weight of a vehicle without driver, passengers or cargo but including fuel, coolant and other items of standard equipment.

Dimension A & B—Front and rear limit of Center of Gravity (CG) zone.

Gross Vehicle Weight Rating or "GVWR" means the value specified by the manufacturer as the loaded weight of a single vehicle.

Gross Axle Weight Rating or "GAWR" means the value specified by the vehicle manufacturer as the load carrying capacity of a single axle system measured at the tire-ground interfaces.

Model Weight—Weight of the vehicle with all items of standard equipment, 150 pounds per passenger in each designated seating position and maximum capacity of fuel, oil and coolant.

Payload Rating—is the maximum allowable load (including the weight of the driver and all occupants) that the vehicle can carry based on all factory-installed equipment on the vehicle.

RPO—Regular Production Option.

Slide-in Camper—means a camper having a roof, floor, and sides, designed to be mounted on and removable from the cargo area of a truck by the user.

Weight Distribution—The amount of a vehicle's weight that rests on each axle.

Wheelbase (WB)—The distance from the center line of the front axle to the center line of the rear axle.

LIMITATIONS

The following General Motors truck models are not recommended for slide-in camper applications:

- Any pickup model with a cargo weight rating (CWR) of less than 500 lbs. A statement to this effect is imprinted on the Truck-Camper Loading information label which states whether that vehicle is recommended for use with a slide-in camper.
- S-10/15 (2WD) Pickup with 4200 lb. GVWR.
- T-10/15 (4x4) Pickup with 4650 lb. GVWR.
- S/T-10/15 Pickup with 108.3" WB.
- S/T-10/15 Extended Cab Pickup.

Note: C/K 1500 Pickups should not be used for larger, cab-over-type slide-in campers.

TRUCK – CAMPER LOADING

S/T PICKUPS, C/K PICKUPS, R/V BONUS AND CREW CAB PICKUPS

INSTRUCTIONS FOR PROSPECTIVE TRUCK PURCHASERS **VEHICLE SELECTION AND WEIGHT ANALYSIS**

1. For S/T-10/15 Models.

You must order S/T 10803 (117.9" WB) model with one of the following GVWR Ratings:

S10803 (2WD) 4600 lb. GVWR

S10803 (2WD) 4900 lb. GVWR

T10803 (4x4) 5150 lb. GVWR

if you intend to use a slide-in camper on your S/T-10/15 Pickup. Record the model on page 3. Record the model GVWR, front GAWR, and rear GAWR on page 9. These ratings can be found in the S/T-10/15 section of the General Motors Light-Duty Truck Facts/Data Book on the Specifications pages.

For C/K, R/V Models.

From the model selection pages of the C/K or R/V Pickup section of the General Motors Light-Duty Truck Facts/Data Book, select the pickup model you desire. Record this information on page 3. Refer to the Specification pages for the selected model. Select the GVWR you require and note any minimum tire size and chassis equipment requirements for that GVWR. (To approximate the GVWR you require, add your loaded camper weight to the vehicle model weight shown on the appropriate weights page of the Facts/Data Book.) Record this GVWR and the Gross Axle Weight Rating (GAWR), Front and Rear (from the Specifications pages), on line 1 of the camper loading worksheet, page 7.

2. Record the front and rear model weights of your selected vehicle on line 2, page 7.
3. List all factory-installed options you desire, including any options required by your selected GVWR, with their front and rear weights on the Pickup camper loading worksheet on page 7.
4. Add the front and rear weights of vehicle model and options to arrive at the total front and rear weight of the vehicle. Follow the directions on page 7, lines 4 through 4C to arrive at the adjusted total vehicle weight.
5. Subtract the adjusted total vehicle weight from the GVWR to arrive at the cargo weight rating (CWR) of your truck ■. Record this information on page 3.
6. Proceed to page 11 and calculate the center of gravity location limits using front and rear GAWRs, cargo weight rating (CWR), and front and rear weight of truck as determined above. Record this information on page 3.
 - The addition of any dealer-installed or other accessories will reduce the cargo-carrying capacity by the weight of the equipment installed.

**TRUCK – CAMPER LOADING
S/T PICKUPS, C/K PICKUPS,
R/V BONUS AND CREW CAB PICKUPS
WORKSHEET – CARGO WEIGHT RATING**

1. Model GVWR _____	GAWR	FRONT _____	REAR _____
2. Model Weights:		FRONT _____	REAR _____
3. Other factory-installed options:			
.....		_____	_____
.....		_____	_____
.....		_____	_____
.....		_____	_____
.....		_____	_____
.....		_____	_____
.....		_____	_____
.....		_____	_____
.....		_____	_____
		TOTALS _____	_____

4. **Front and Rear Weight:** _____

4a. **Vehicle sub-total weight** (add front and rear weight): _____

4b. **Add 50 lbs. for all models*** _____ +50

4c. **Adjusted total vehicle weight:** _____

5. **Vehicle GVWR:** _____

Adjusted total vehicle weight (– _____)

Cargo Weight Rating _____

Record on page 3.

*If your vehicle is available, drive to a scale and weigh the front and the rear separately to determine the axle loads. You will then be able to use your actual cargo weight rating and not have to add the 50#.

TRUCK - CAMPER LOADING DIMENSIONS

S-10/15 PICKUPS

LONG BOX (MODEL S/T10803)

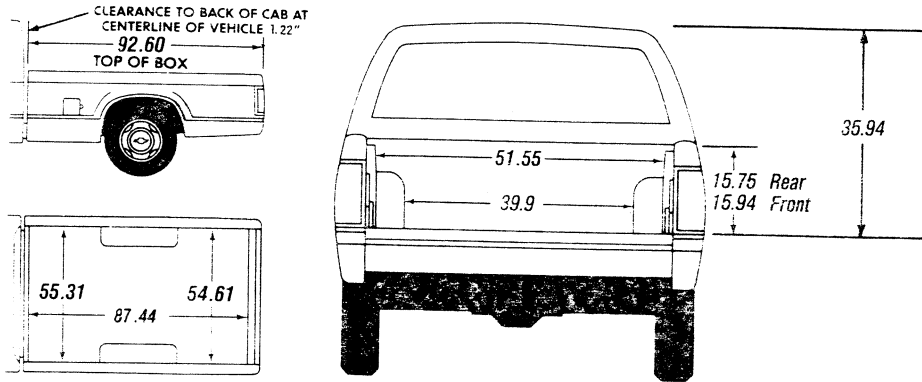

C/K PICKUPS

FLEETSIDE/WIDESIDE SHORT BOX (MODELS C/K10703, C/K10753, C/K20753)

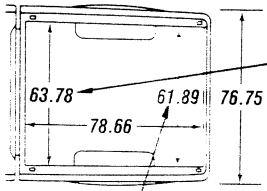
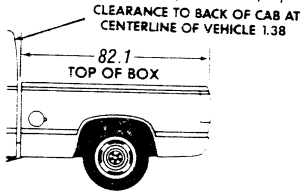

INSIDE WIDTH, TOP REAR FLANGE

FLEETSIDE/WIDESIDE LONG BOX (MODELS C/K10903, C/K20903, C/K30903, C/K10953, C/K20953, C/K30953)

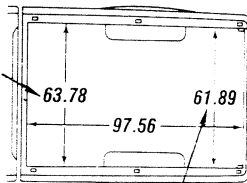
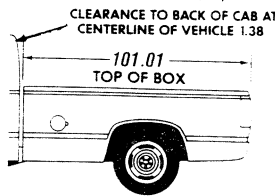

INSIDE WIDTH, TOP REAR FLANGE

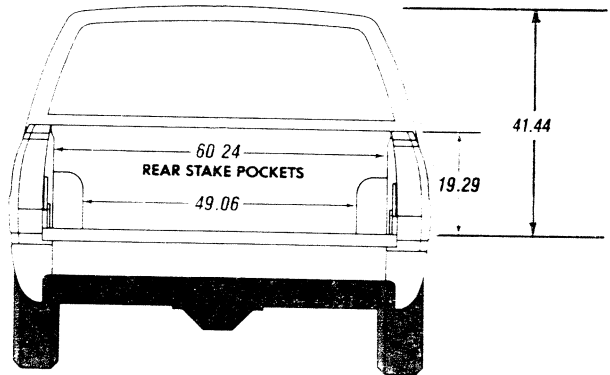

C/K REGULAR CAB PICKUP

(MODELS C/K10703)

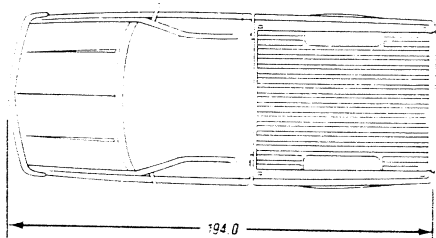
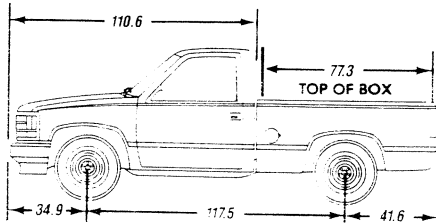

(MODELS C/K10903, C/K20903, C/K30903)

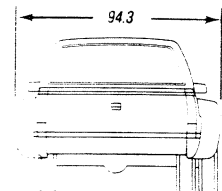
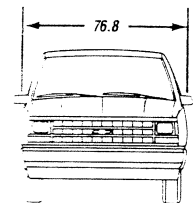
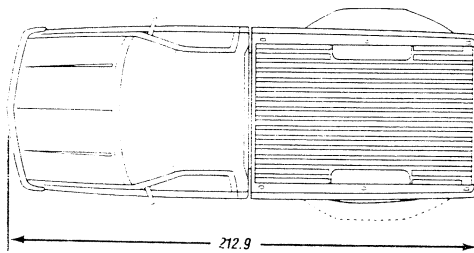
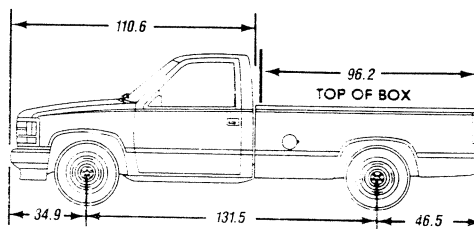

TRUCK - CAMPER LOADING

DIMENSIONS

C/K PICKUPS

SPORTSIDE SHORT BOX

(MODELS C/K 10703)

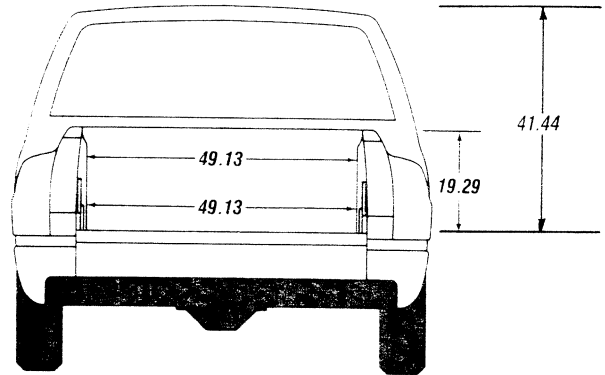
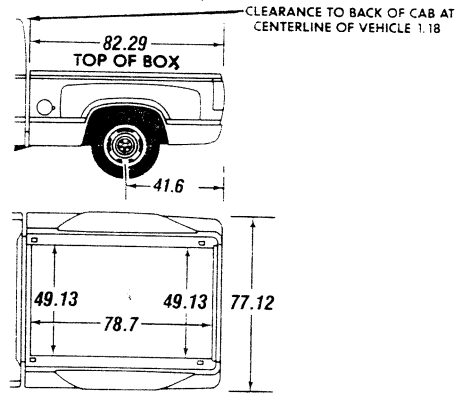

C/K EXTENDED CAB PICKUP

FLETSIDE/WIDESIDE LONG BOX

(MODELS C/K10953, C/K20953, C/K30953)

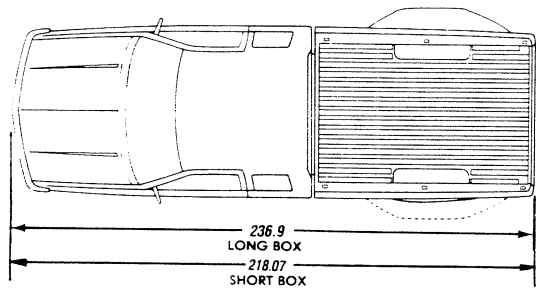
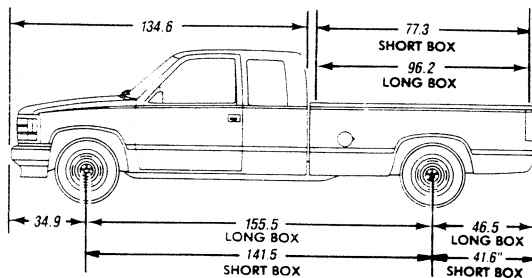

R/V PICKUPS

FLETSIDE/WIDESIDE LONG BOX

(MODELS R/V30943)

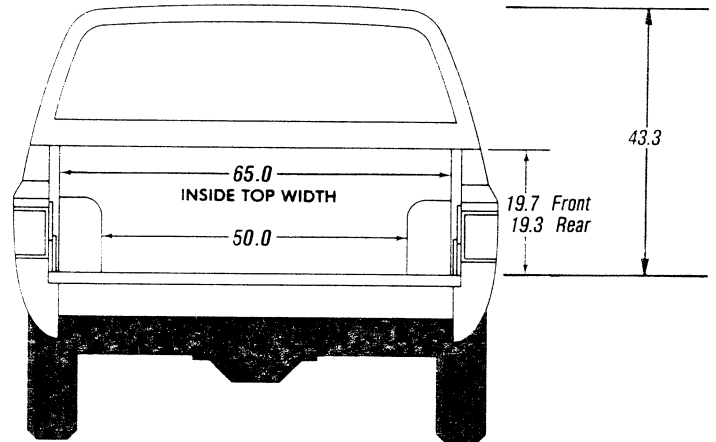
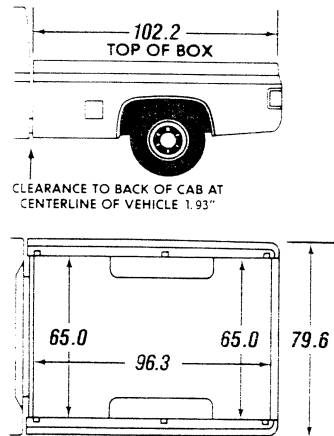

R/V BONUS/CREW CAB PICKUP

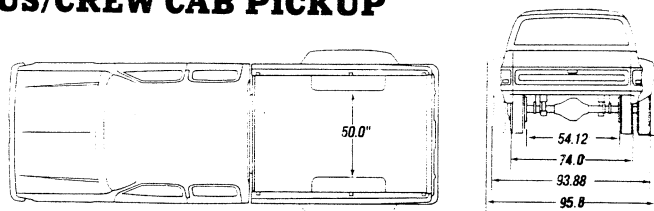
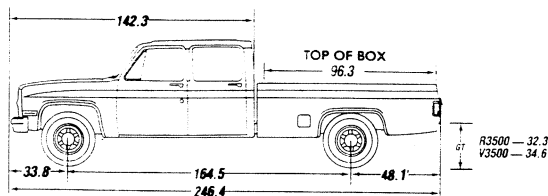

TRUCK - CAMPER LOADING

MODEL CODES AND DIMENSIONS

SERIES	MODEL NUMBER	PICKUP BOX LENGTH	PICKUP STYLE	WB	"C"*
--------	--------------	-------------------	--------------	----	------

REGULAR CAB MODELS

S/T10/15	S/T10803	7½'	Fleetside/Wideside (E63)	117.9"	42.40"
C/K1500	C/K10703	6½'	Fleetside/Wideside (E63) Sportside (E62)	117.5"	38.70"
	C/K10903	8'	Fleetside/Wideside (E63)	117.5"	38.61"
C/K2500	C/K20903	8'	Fleetside/Wideside (E63)	131.5"	43.57"
C/K3500	C/K30903	8'	Fleetside/Wideside (E63)	131.5"	43.57"

EXTENDED CAB MODELS

C/K1500	C/K10753	6½'	Fleetside/Wideside (E63)	141.5"	38.70"
	C/K10953	8'	Fleetside/Wideside (E63)	155.5"	43.57"
C/K2500	C/K20753	6½'	Fleetside/Wideside (E63)	141.5"	38.70"
	C/K20953	8'	Fleetside/Wideside (E63)	155.5"	43.57"
C/K3500	C/K30953	8'	Fleetside/Wideside (E63)	155.5"	43.57"

BONUS CAB MODEL

R/V3500	R/V30943	8'	Fleetside/Wideside (E63 & YG4)	164.5"	44.22"
---------	----------	----	--------------------------------	--------	--------

CREW CAB MODEL

R/V3500	R/V30943	8'	Fleetside/Wideside (E63 & AS3)	164.5"	44.22"
---------	----------	----	--------------------------------	--------	--------

*Dimension "C" is the distance from the centerline of the rear axle to the end of the pickup box floor.
Dimensions A and B can be calculated by using the formula on page 11.

S-10/15 PICKUP

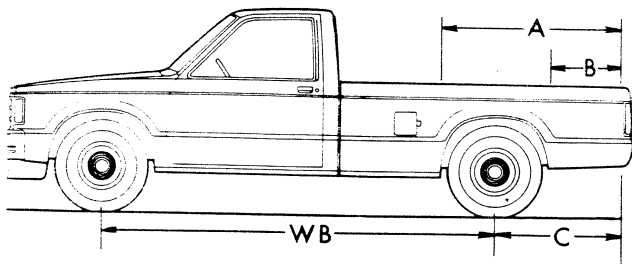

R/V PICKUP

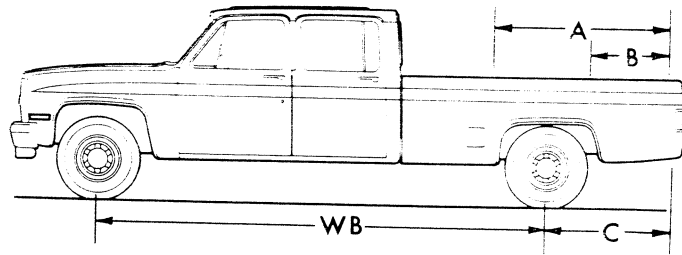

C/K PICKUP

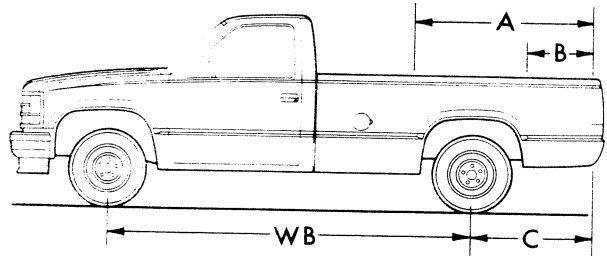

C/K PICKUP

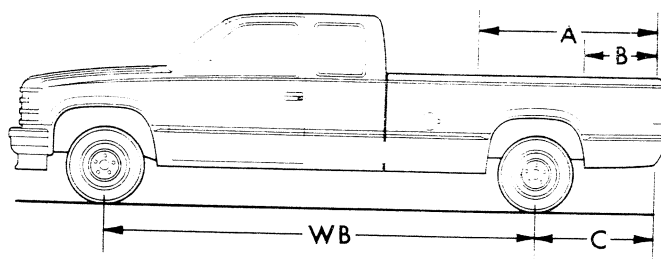

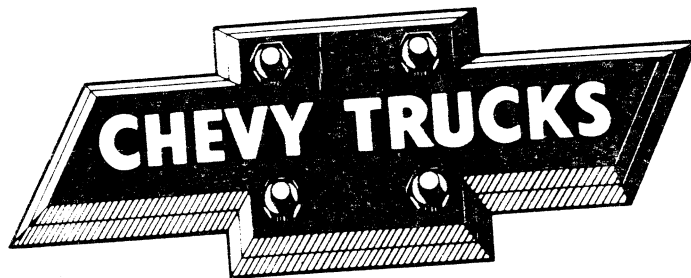

CHEVROLET MOTOR DIVISION
30007 VAN DYKE AVENUE
WARREN, MICHIGAN 48090



GMC TRUCK DIVISION
31 JUDSON STREET
PONTIAC, MICHIGAN 48058

Litho in U.S.A.

TRUCK – CAMPER LOADING

CALCULATIONS TO DETERMINE FORWARD (A) AND REARWARD (B) LOCATION OF CENTER OF GRAVITY FOR CARGO WEIGHT RATING

Calculations for Dimension A

$$A = \left\{ \frac{\text{Front GAWR} - 1.05 \times \text{Front Weight of Truck}}{\text{Cargo Weight Rating}} \right\} \times \text{W.B.} + C$$

Enter Front GAWR _____

Subtract Front Weight of Truck × 1.05 -(_____)

Answer _____

Divide Answer by Cargo Weight Rating (CWR) ÷ _____

Answer _____

Multiply Answer by Wheelbase × _____

(See Chart on Page 10)

Answer _____

Add C Dimension to Answer + C _____

(See Chart on Page 10)

Dimension A = _____

Note: If "A" is greater than pickup box length, use box length for "A" dimension.

Calculations for Dimension B

$$B = \left\{ 1 - \frac{\text{Rear GAWR} - 1.1 \times \text{Rear Weight of Truck}}{\text{Cargo Weight Rating}} \right\} \times \text{W.B.} + C$$

Enter Rear GAWR _____

Subtract Rear Weight of Truck × 1.1 -(_____)

Answer _____

Divide Answer by Cargo Weight Rating (CWR) ÷ _____

Answer _____

Subtract Answer from 1.000- -(_____)

Multiply Answer by Wheelbase × _____

Answer _____

Add C Dimension to Answer + C _____

Dimension B = _____

Note: If "B" dimension is negative, use 0 (zero) for "B" dimension.
If "B" dimension is greater than "A" dimension, camper usage is not recommended at the Calculated Cargo Weight Rating. Camper usage may be possible for a lighter camper. Substitute known specific camper weight (less than Cargo Weight Rating) for Cargo Weight Rating in calculations above to determine "A" to "B" range for that specific camper.

Record dimension A and B on page 3.

K PICKUP

†: Red Print Indicates Not Available in California **Bold Print** Indicates Not Available w/High Altitude Emissions

TWO-WHEEL DRIVE MODELS

C1500 REGULAR CAB SPORTSIDE



MODEL NUMBER	BOX (FT.)	GVWR (LBS.)	MAX ¹ PAYLOAD (LBS.)	PASS. CAP. (STD/OPT)	STD ENGINE/ TRANS	OPT ENGINE/ TRANS
CC10703/E62	6.5	5600	1879	3/2	4.3L V6/M5	4.3L V6/A4 5.0L V8/M5/A4 5.7L V8/M5/A4

C1500 REGULAR CAB SPORTSIDE
The Sportside features a specialized cargo-bed design with a fully-rectangular cargo box on the inside, and fiberglass side panels flanked by running board steps on the outside.

C1500 REGULAR CAB FLEETSIDE



MODEL NUMBER	BOX (FT.)	GVWR (LBS.)	MAX ¹ PAYLOAD (LBS.)	PASS. CAP. (STD/OPT)	STD ENGINE/ TRANS	OPT ENGINE/ TRANS
CC10703/E63	6.5	5600	1899	3/2	4.3L V6/M5	4.3L V6/A4 5.0L V8/M5/A4 5.7L V8/M5/A4

C1500 REGULAR CAB FLEETSIDE
The C1500 Fleetside is the most popular full-size model with a 6.5-foot cargo box and a variety of powertrains and GVWRs to meet the needs of today's truck buyers.

C1500 REGULAR CAB FLEETSIDE 454 SS (B4U)



MODEL NUMBER	BOX (FT.)	GVWR (LBS.)	MAX ¹ PAYLOAD (LBS.)	PASS. CAP. (STD/OPT)	STD ENGINE/ TRANS	OPT ENGINE/ TRANS
CC10703/E63/B4U	6.5	5600	1603	2/-	7.4LV8/A4	—

C1500 REGULAR CAB FLEETSIDE 454 SS (B4U)
The 454 SS is available with a 7.4L V8 engine, high performance capabilities, and increased comfort to meet the needs of today's sport-truck buyer.

C1500 REGULAR CAB FLEETSIDE WT 1500 (VLA)

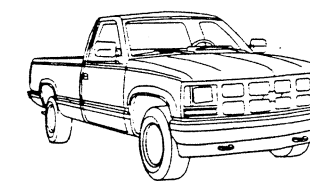

MODEL NUMBER	BOX (FT.)	GVWR (LBS.)	MAX ¹ PAYLOAD (LBS.)	PASS. CAP. (STD/OPT)	STD ENGINE/ TRANS	OPT ENGINE/ TRANS
CC10903/E63/VLA	8	5600	1766	3/-	4.3L V6/M5	4.3L V6/A4
CC10903/E63/VLA/F44	8	6100	2554	3/-	4.3L V6/M5	4.3L V6/A4

C1500 REGULAR CAB FLEETSIDE WT 1500 (VLA)
The WT 1500 (VLA) is an economy model for price-conscious buyers. It is offered with an 8-foot cargo box, one trim level, two GVWRs and limited option availability.

C1500 REGULAR CAB FLEETSIDE

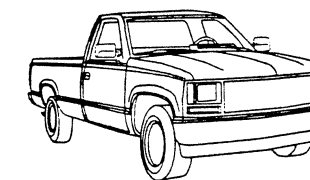

MODEL NUMBER	BOX (FT.)	GVWR (LBS.)	MAX ¹ PAYLOAD (LBS.)	PASS. CAP. (STD/OPT)	STD ENGINE/ TRANS	OPT ENGINE/ TRANS
CC10903/E63	8	5600	1762	3/2	4.3L V6/M5	4.3L V6/M4/A4 5.0L V8/M5/A4 5.7L V8/M4/M5/A4
CC10903/E63/B3J	8	6100	1741	3/2	6.2L V8/M4	6.2L V8/A4
CC10903/E63/F44	8	6100	2250	3/2	4.3L V6/M5	4.3L V6/M4/A4 5.0L V8/M5/A4 5.7L V8/M4/M5/A4

C1500 REGULAR CAB FLEETSIDE
The C1500 Fleetside is the most popular full-size model. It's available with an 8-foot cargo box and a variety of powertrains and two GVWRs to meet the needs of today's truck buyers.

Based on Curb Weight.



CONTENTS

	<u>Page</u>
MODELS	2
WT 1500 WORK TRUCK (VLA) TRIM	6
CHEYENNE (STANDARD) TRIM	7
SCOTTSDALE (Z62) TRIM	8
SILVERADO (YE9) TRIM	9
454 SS (B4U) TRIM	10
POWERTRAINS	11
STANDARD SUSPENSION (TWO-WHEEL DRIVE MODELS)	18
OPTIONAL SUSPENSION (FOUR-WHEEL DRIVE MODELS)	19
STANDARD SUSPENSION (TWO-WHEEL DRIVE MODELS)	20
OPTIONAL SUSPENSION (FOUR-WHEEL DRIVE MODELS)	21
WHEELS AND TIRES	22
FRAME/STEERING/BRAKES	26
ELECTRICAL	28
COOLING	29
DIMENSIONS	30
OPTIONS	33
COLOR COMBINATIONS	38
EXTERIOR COLORS	B
INTERIOR TRIM	C
SEATS	D
TRAILERING	E

K PICKUP

Y: Red Print Indicates Not Available in California **Bold Print** Indicates Not Available w/High Altitude Emissions

FOUR-WHEEL DRIVE MODELS

K1500 REGULAR CAB SPORTSIDE

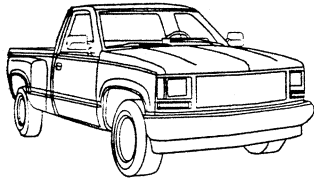

MODEL NUMBER	BOX (FT.)	GVWR (LBS.)	MAX ¹ PAYLOAD (LBS.)	PASS. CAP. (STD/OPT)	STD ENGINE/ TRANS	OPT ENGINE/ TRANS
CK10703/E62	6.5	5600	1459	3/2	4.3L V6/M5	4.3L V6/A4 5.0L V8/M5/A4 5.7L V8/M4/M5/A4
CK10703/E62/F44	6.5	6100	1935	3/2	4.3L V6/M5	4.3L V6/M4/A4 5.0L V8/M5/A4 5.7L V8/M4/M5/A4

K1500 REGULAR CAB SPORTSIDE

The Sportside features a specialized cargo-bed design with a fully-rectangular cargo box on the inside, and fiberglass side panels flanked by running board steps on the outside.

K1500 REGULAR CAB FLEETSIDE

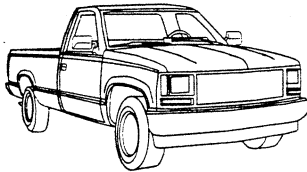

MODEL NUMBER	BOX (FT.)	GVWR (LBS.)	MAX ¹ PAYLOAD (LBS.)	PASS. CAP. (STD/OPT)	STD ENGINE/ TRANS	OPT ENGINE/ TRANS
CK10703/E63	6.5	5600	1489	3/2	4.3L V6/M5	4.3L V6/M4/A4 5.0L V8/M5/A4 5.7L V8/M4/M5/A4
CK10703/E63/F44	6.5	6100	1968	3/2	4.3L V6/M5	4.3L V6/M4/A4 5.0L V8/M5/A4 5.7L V8/M4/M5/A4

K1500 REGULAR CAB FLEETSIDE

The K1500 Fleetside is the most popular full-size model. It's available with a 6.5-foot cargo box and a variety of powertrains and two GVWRs to meet the needs of today's truck buyer.

K1500 REGULAR CAB FLEETSIDE WT 1500 (VLA)

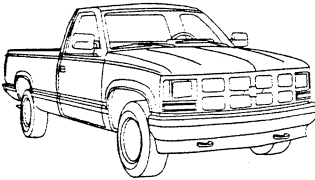

MODEL NUMBER	BOX (FT.)	GVWR (LBS.)	MAX ¹ PAYLOAD (LBS.)	PASS. CAP. (STD/OPT)	STD ENGINE/ TRANS	OPT ENGINE/ TRANS
CK10903/E63/VLA	8	5600	1340	3/2	4.3LV6/M5	4.3L V6/A4
CK10903/E63/VLA/F44	8	6100	1819	3/2	4.3L V6/M5	4.3L V6/A4

K1500 REGULAR CAB FLEETSIDE WT 1500 (VLA)

The WT 1500 (VLA) is an economy model for price-conscious buyers. It is offered with an 8-foot cargo box, one trim level, two GVWRs and limited option availability.

K1500 REGULAR CAB FLEETSIDE

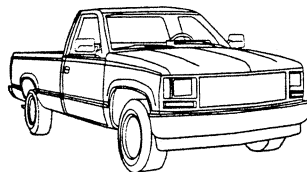

MODEL NUMBER	BOX (FT.)	GVWR (LBS.)	MAX ¹ PAYLOAD (LBS.)	PASS. CAP. (STD/OPT)	STD ENGINE/ TRANS	OPT ENGINE/ TRANS
CK10903/E63	8	5600	1336	3/2	4.3L V6/M5	4.3L V6/M4/A4 5.0L V8/M5/A4 5.7L V8/M4/M5/A4
CK10903/E63/B3J	8	6100	1440	3/2	6.2L V8/M5	6.2L V8/A4
CK10903/E63/F44	8	6100	1817	3/2	4.3L V6/M5	4.3L V6/M4/A4 5.0L V8/M5/A4 5.7L V8/M4/M5/A4

K1500 REGULAR CAB FLEETSIDE WT 1500

The K1500 Fleetside is the most popular full-size model. It's available with an 8-foot cargo box, a variety of powertrains and two GVWRs to meet the needs of today's truck buyer.

K1500 EXTENDED CAB FLEETSIDE

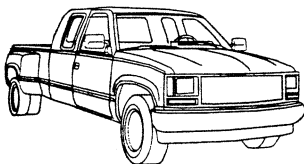

MODEL NUMBER	BOX (FT.)	GVWR (LBS.)	MAX ¹ PAYLOAD (LBS.)	PASS. CAP. (STD/OPT)	STD ENGINE/ TRANS	OPT ENGINE/ TRANS
CK10753/E63	6.5	6200	1750	3/5/6	4.3L V6/M5	4.3L V6/M4/A4 5.0L V8/M5/A4 5.7L V8/M4/M5/A4
CK10753/E63/B3J	6.5	6600	1572	3/5/6	6.2L V8/M4	6.2L V8/A4
CK10753/E63/F44	6.5	6600	1639	3/5/6	4.3L V6/M5	4.3L V6/M4/A4 5.0L V8/M5/A4 5.7L V8/M4/M5/A4
CK10953/E63	8	6200	1615	3/5/6	4.3L V6/M5	4.3L V6/M4/A4 5.0L V8/M5/A4 5.7L V8/M4/M5/A4
CK10953/E63/B3J	8	6600	1431	3/5/6	6.2L V8 M4	6.2L V8/A4
CK10953/E63/F44	8	6600	1994	3/5/6	4.3L V6/M5	4.3L V6/M4/A4 5.0L V8/M5/A4 5.7L V8/M4/M5/A4

K1500 EXTENDED CAB FLEETSIDE

The K1500 Extended Cab offers a cab design with a generous amount of secure in-cab storage behind the front seat and a choice of a 6.5-foot or an 8-foot cargo box. An optional three-passenger rear seat is available.

¹Based on Curb Weight.

Key: Red Print Indicates Not Available in California **Bold Print** Indicates Not Available w/High Altitude Emissions

TWO WHEEL DRIVE MODELS

C1500 EXTENDED CAB FLEETSIDE

The C1500 Extended Cab model offers a cab design with a generous amount of secure in-cab storage behind the front seat and a choice of a 6.5-foot or an 8-foot cargo box. An optional three-passenger rear seat is available.

C1500 EXTENDED CAB FLEETSIDE

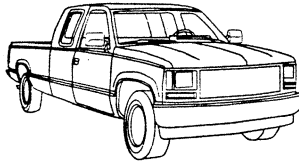

MODEL NUMBER	BOX (FT.)	GVWR (LBS.)	MAX ¹ PAYLOAD (LBS.)	PASS. CAP. (STD/OPT)	STD ENGINE/TRANS	OPT ENGINE/TRANS
CC10753/E63	6.5	6200	2150	3/5/6	4.3L V6/M5	4.3L V6/M4/A4 5.0L V8/M5/A4 5.7L V8/M4/M5 A4
CC10753/E63/B3J	6.5	6200	2080	3/5/6	6.2L V8/M4	6.2L V8/A4
CC10953/E63	8	6200	2048	3/5/6	4.3L V6/M5	4.3L V6/M4/A4 5.0L V8/M5/A4 5.7 V8/M4/M5/A4
CC10953/E63/B3J	8	6200	1612	3/5/6	6.2L V8/M4	6.2L V8/A4

C2500 REGULAR CAB FLEETSIDE

The C2500 Regular Cab offers increased GVWR capacity over the C1500 series.²

C2500 REGULAR CAB FLEETSIDE

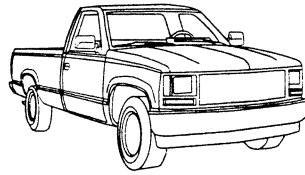

MODEL NUMBER	BOX (FT.)	GVWR (LBS.)	MAX ¹ PAYLOAD (LBS.)	PASS. CAP. (STD/OPT)	STD ENGINE/TRANS	OPT ENGINE/TRANS
CC20903/E63	8	7200	3198	3/2	4.3L V6/M5	4.3L V6/M4/A4 5.0L V8/M5/A4 5.7L V8/M4/M5 A4
CC20903/E63/B3J	8	7200	2608	3/2	6.2L V8/M4	6.2L V8/A4
CC20903/E63/C6P	8	8600	4368	3/2	4.3L V6/M4	4.3L V6/A4 5.7L V8/M4/A4 7.4L V8/M4/A4
CC20903/E63/B3J/C6P	8	8600	3617	3/2	6.2L V8/M4	6.2L V8/A4

C2500 EXTENDED CAB FLEETSIDE

The C2500 Extended Cab offers the versatility of extended cab design coupled with the GVWR availability of the C2500 series. It is available with a 6.5-foot or an 8-foot cargo box.²

C2500 EXTENDED CAB FLEETSIDE

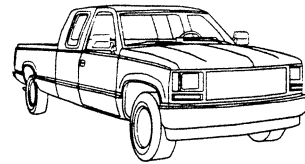

MODEL NUMBER	BOX (FT.)	GVWR (LBS.)	MAX ¹ PAYLOAD (LBS.)	PASS. CAP. (STD/OPT)	STD ENGINE/TRANS	OPT ENGINE/TRANS
CC20753/E63	6.5	7200	3039	3/5/6	4.3L V6/M5	4.3L V6/M4/A4 5.0L V8/M5/A4 5.7 V8/M4/M5/A4
CC20753/E63/B3J	6.5	7200	2217	3/5/6	6.2L V8/M4	6.2L V8/A4
CC20953/E63	8	7200	2933	3/5/6	4.3L V6/M5	4.3L V6/M4/A4 5.0L V8/M5/A4 5.7L V8/M4/M5 A4
CC20953/E63/B3J	8	7200	2425	3/5/6	6.2L V8/M4	6.2L V8/A4
CC20953/E63/C6P	8	8600	4073	3/5/6	4.3L V6/M4	4.3L V6/A4 5.7L V8/M4/A4 7.4L V8/M4/A4
CC20953/E63/B3J/C6P	8	8600	3413	3/5/6	6.2L V8/M4	6.2L V8/A4

C3500 REGULAR CAB BIG DOOLEY w/DUAL REAR WHEELS

The C3500 Big Dooley offers the highest GVWR available in the C/K Pickup series. The Big Dooley is equipped with dual rear wheels and plastic rear fender extensions.²

C3500 BIG DOOLEY

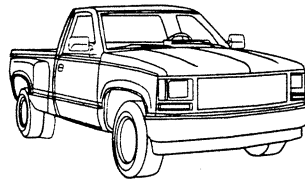

MODEL NUMBER	BOX (FT.)	GVWR (LBS.)	MAX ¹ PAYLOAD (LBS.)	PASS. CAP. (STD/OPT)	STD ENGINE/TRANS	OPT ENGINE/TRANS
CC30903/E63	8	10,000	5055	3/2	5.7L V8/M4	5.7L V8/M4/A4 7.4L V8/M4/A4
CC30903/E63/B3J	8	10,000	5110	3/2	6.2L V8/M4	6.2L V8/A4

C3500 EXTENDED CAB BIG DOOLEY w/Dual REAR WHEELS

The C3500 Extended Cab Big Dooley w/Dual Rear Wheels offers the versatility of extended cab design and high GVWR, as well as plastic rear fender extensions.²

C3500 BIG DOOLEY

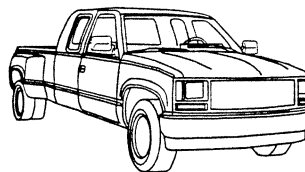

MODEL NUMBER	BOX (FT.)	GVWR (LBS.)	MAX ¹ PAYLOAD (LBS.)	PASS. CAP. (STD/OPT)	STD. ENGINE/TRANS.	OPT. ENGINE/TRANS.
CC30953/E63	8	10,000	4757	3/5/6	5.7L V8/M4	5.7L V8/A4 7.4L V8/M4/A4
CC30953/E63/B3J	8	10,000	4458	3/5/6	6.2L V8/M4	6.2L V8/A4

¹Based on Curb Weight.

²Models at or above 8600 lbs. GVWR do not include air dam.

WT 1500 WORK TRUCK (VLA)

The "WT" 1500 Regular Cab Work Truck (VLA) is available as a C/K 10903 Fleetside with Cheyenne trim only and has limited option availability.

The following features are standard.

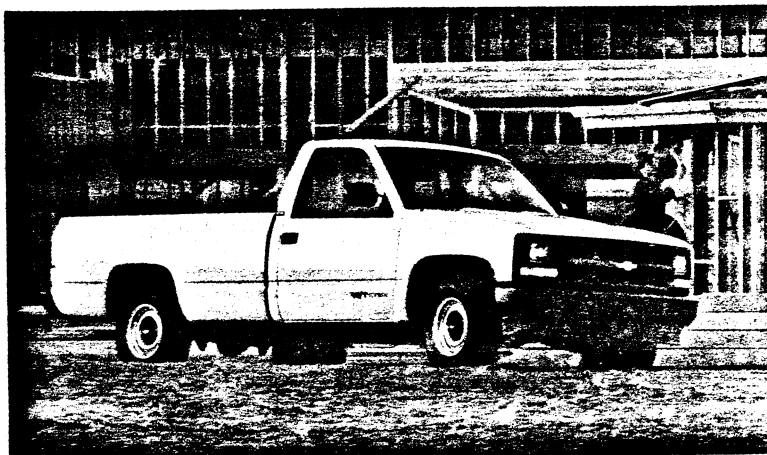

Some equipment shown may be optional or extra cost.

POWERTRAIN/CHASSIS

- ALTERNATOR: 85 Amp Delcotron.
- BATTERY: 12 volt, neg. ground; 630 CCA @ 0 degrees F.
- BRAKES: Power; vaccum. Front—disc. Rear—drum. Includes rear wheel anti-lock braking system.
- ENGINE: 4.3-liter V6 (EFI). 160 net HP @ 4000 rpm and 235 lb. ft. of net torque @ 2400 rpm.
- EXHAUST: Single.
- FRAME: All-welded ladder-type, channel design and boxed front-end section.
- FUEL TANK: 34.0 gallon (approx.)
- REAR AXLE: Hypoid, Semi-Floating. Axle ratio: 3.08:1
- SHOCK ABSORBERS: —25 mm piston dia. front and rear.
- STABILIZER BAR: Front—1.25 inch diameter on 2-wheel drive models and 1.18 inch diameter on 4-wheel drive models.
- STEERING: Integral Power. Ratio—16/13:1.
- SUSPENSION: Front—Independent with computer-selected springs. Two-wheel drives with coil springs, four-wheel drives with torsion bars. Rear—Semi Elliptic two-stage multi-leaf springs.
- TOW HOOKS: Two front on 4-wheel drives.
- TRANSMISSION: Manual 5-speed with overdrive.

EXTERIOR

- AIR DAM: Dark argent metallic.
- BODY SIDE DECALS: "WT1500" with integrated bow tie.
- BUMPER: Dark argent metallic front.
- COLORS: Choice of four in a solid paint scheme.
 - Smoke Blue Metallic
 - Summit White
 - Flame Red
 - Quicksilver Metallic
- GRILLE: Impact resistant, dark argent metallic.
- HEADLAMPS: Single rectangular halogen.
- HORN: Single electric low-note.
- MIRRORS: Black RH and LH below-eye-line type with adjustable heads. Head size is 9.0" x 6.5".
- NAMEPLATE: Cheyenne.
- PICKUP BOX: All-welded 8-foot, double wall construction and extensive corrosion protection throughout.
- SPARE TIRE: Delete.
- SPARE TIRE CARRIER: Delete.
- TIRES: Four steel-belted radial tires. P225/75R15 tires on the 2-wheel drives and LT225/75R16C on the 4-wheel drives.
- WHEELS: Four silver painted steel wheels with black hub ornament; 15.0" x 6.0" on 2-wheel drives and 16.0" x 6.5" on 4-wheel drives.

INTERIOR

- ARMREST: RH and LH padded; integral with door panels.
- CIGARETTE LIGHTER.
- COAT HOOK: RH.
- COLORS: Choice of five interior. See Color and Trim specifications for details.
- DOME LAMP: Switch in LH door jamb.
- DOOR PANELS: Grained molded plastic.
- DOOR SILL PLATE: Gray.
- FLOOR COVERING: Embossed black rubber mat.
- GAGES: Including speedometer, odometer, fuel level, voltmeter, temperature, oil pressure and additional telltale lights.
- GLOVE BOX: Latched door and beverage holder.
- HEADLINER: Vinyl with matching retainer moldings.
- HEATER: Deluxe with windshield and side window defoggers.
- INSULATION: Provided on dash panel, cowl top and sides, and doors.
- MIRROR: 10-inch rearview.
- RADIO: Delete.
- SEATS: 3-passenger all-vinyl trim front bench with folding backrest.
- STEERING WHEEL: Custom urethane 4-spoke.
- SUNSHADES: Color-keyed vinyl RH and LH padded.
- TOOLS: Mechanical jack and wheel wrench located behind front seat.
- WINDOWS: Tinted glass.
- WINDSHIELD WIPERS: Intermittent.

KEY: Red Print Indicates Not Available In California **Bold Print** Indicates Not Available w/High Altitude Emissions

FOUR-WHEEL DRIVE MODELS

K2500 REGULAR CAB FLEETSIDE

The K2500 Regular Cab offers increased GVWR capacity over the K1500 series.²

K2500 REGULAR CAB FLEETSIDE

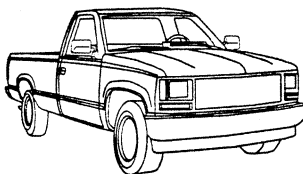

MODEL NUMBER	BOX (FT.)	GVWR (LBS.)	MAX ¹ PAYLOAD (LBS.)	PASS. CAP. (STD/OPT)	STD ENGINE/ TRANS	OPT ENGINE/ TRANS
CK20903/E63	8	7200	2848	3/2	4.3L V6/M5	4.3L V6/M4/A4 5.0L V8/M5/A4 5.7L V8/M4/M5/A4
CK20903/E63/B3J	8	7200	2339	3/2	6.2L V8/M4	6.2L V8/A4
CK20903/E63/C6P	8	8600	4000	3/2	4.3L V6/M4	4.3L V6/A4 5.7L V8/M4/A4 7.4L V8/M4/A4
CK20903/E63/B3J/C6P	8	8600	3739	3/2	6.2L V8/M4	6.2L V8/A4

K2500 EXTENDED CAB FLEETSIDE

The K2500 Extended Cab offers the versatility of extended cab design coupled with the GVWR availability of the K2500 series. It is available with a 6.5-foot or an 8-foot cargo box.²

K2500 EXTENDED CAB FLEETSIDE

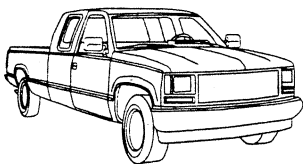

MODEL NUMBER	BOX (FT.)	GVWR (LBS.)	MAX ¹ PAYLOAD (LBS.)	PASS. CAP. (STD/OPT)	STD ENGINE/ TRANS	OPT ENGINE/ TRANS
CK20753/E63	6.5	7200	2719	3/5/6	4.3L V6/M5	4.3L V6/M4/A4 5.0L V8/M5/A4 5.7L V8/M4/M5/A4
CK20753/E63/B3J	6.5	7200	2817	3/5/6	6.2L V8/M4	6.2L V8/A4
CK20953/E63	8	7200	2511	3/5/6	4.3L V6/M5	4.3L V6/M4/A4 5.0L V8/M5/A4 5.7L V8/M4/M5/A4
CK20953/E63/B3J	8	7200	1668	3/5/6	6.2L V8/M4	6.2L V8/A4
CK20953/E63/C6P	8	8600	3628	3/5/6	4.3L V6/M4	4.3L V6/A4 5.7L V8/M4/A4 7.4L V8/M4/A4
CK20953/E63/B3J/C6P	8	8600	3739	3/5/6	6.2L V8/M4	6.2L V8/A4

K3500 REGULAR CAB BIG DOOLEY w/DUAL REAR WHEELS

The K3500 Big Dooley offers the highest GVWR available in the C/K Pickup series, as well as dual rear wheels and plastic rear fender extensions.²

K3500 REGULAR CAB BIG DOOLEY

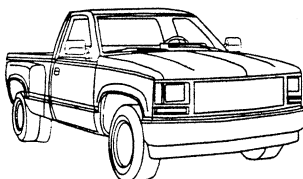

MODEL NUMBER	BOX (FT.)	GVWR (LBS.)	MAX ¹ PAYLOAD (LBS.)	PASS. CAP. (STD/OPT)	STD ENGINE/ TRANS	OPT ENGINE/ TRANS
CK30903/E63	8	10,000	4684	3/2	5.7L V8/M4	5.7L V8/A4 7.4L V8/M4/A4
CK30903/E63/B3J	8	10,000	4739	3/2	6.2L V8/M4	6.2L V8/A4

K3500 EXTENDED CAB BIG DOOLEY w/DUAL REAR WHEELS

The K3500 Extended Cab Big Dooley w/dual rear wheels offers the versatility of extended cab design, high GVWR, as well as plastic rear fender extensions.²

K3500 EXTENDED CAB BIG DOOLEY

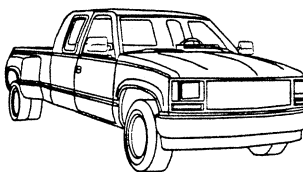

MODEL NUMBER	BOX (FT.)	GVWR (LBS.)	MAX ¹ PAYLOAD (LBS.)	PASS. CAP. (STD/OPT)	STD ENGINE/ TRANS	OPT ENGINE/ TRANS
CK30953/E63	8	10,000	4347	3/5/6	5.7L V8/M4	5.7L V8/A4 7.4L V8/M4/A4
CK30953/E63/B3J	8	10,000	4468	3/5/6	6.2L V8/M4	6.2L V8/A4

¹Based on Curb Weight.

²Models at or above 8600 lbs. GVWR do not include air dam.

SCOTTSDALE

(Z62)

The Scottsdale trim level is an optional trim level for the C/K series. It is designed to offer truck buyers an increased level of comfort and convenience features compared to the standard Cheyenne trim level.

The following features are standard. Bold type denotes equipment in addition to or replacing that of the Cheyenne trim level.



Some equipment shown may be optional or extra cost.

POWERTRAIN/CHASSIS

- ALTERNATOR: 85 Amp Delcotron.
- BATTERY: Gas engines—12 volt, neg. ground; 630 CCA @ 0 degrees F. Diesel engines—Two 12 volt, neg. ground; 570 CCA @ 0 degrees F.
- BRAKES: Power; vacuum. Front—disc. Rear—drum. (except C/K3500) Includes rear wheel anti-lock. C/K3500—Power; hydraulic. Front—disc. Rear—drum. Includes rear wheel anti-lock braking system.
- ENGINE: 4.3-liter V6 EFI on C/K1500 and 7200-lb. GVWR C/K2500. 160 net HP @ 4000 rpm and 235 lb. ft. of net torque @ 2400 rpm. Heavy-Duty 4.3-liter V6 EFI on C/K2500 at 8600-lb. GVWR. 150 net HP @ 4000 rpm and 230 lb. ft. of net torque @ 2400 rpm. 6.2-liter V8 diesel with mechanical fuel

injection is available with B3J diesel equip. 5.7-liter V8 EFI on C/K3500. 190 net HP @ 4000 rpm and 300 lb. ft. of net torque @ 2400 rpm. (See Powertrains for details.)

- EXHAUST: Single.
- FRAME: All-welded ladder-type, channel design and boxed front-end section.
- FUEL TANK: 25.0-gallon (approx.) on C/K10703, C/K10753 and C/K20753. 34.0-gallon (approx.) on C/K10903, C/K10953, C/K20903, C/K20953 and C/K3500.
- REAR AXLE: Hypoid, Semi-Floating on C/K1500, and C/K2500. Hypoid, Full-Floating on C/K3500. Standard axle ratios vary.
- SHOCK ABSORBERS:—25 mm piston dia. front and rear on C/K1500. —32 mm piston dia. front on C/K2500 at

7200 lbs. GVWR and C/K3500. Also, rear on C/K2500 and C/K3500.

- 35 mm piston dia. front on C/K2500 at 8600 lbs. GVWR.
- STABILIZER BAR: Front—1.25 inch diameter on 2-wheel drive models and 1.18 inch diameter on 4-wheel drive models.
- STEERING: Integral Power. Ratio—16/13:1.
- SUSPENSION: Front—Independent with computer-selected springs. Two-wheel drives with coil springs; four-wheel drives with torsion bars. Rear—Multi-Leaf springs; Semi-Elliptic two-stage on all models except C/K3500. Combined Semi-Elliptic two-stage Main/Auxiliary on C/K3500.
- TOW HOOKS: Two front on 4-wheel drives.
- TRANSMISSION: Manual (4-speed or 5-speed depending on model).

EXTERIOR

- AIR DAM: Black. (Not included on models at or above 8600 lbs. GVWR).
- BUMPER: Chrome front with **black strip**.
- COLORS: Choice of ten in a solid paint scheme. See Color and Trim specifications for details.
- GRILLE: **Deluxe dark argent grille with bright trim**.
- HEADLAMPS: **Composite halogen**.
- HORN: **Dual low- and high-note**.
- MOLDINGS: **Black body side and wheel**

opening (except K2500 C6P, K3500, and Sportside models.)

- MIRRORS: Black RH and LH below-eye-line type with adjustable heads. Head size is 9.0" x 6.5".
- NAMEPLATE: **Scottsdale**.
- PICKUP BOX: All-welded double wall construction and extensive corrosion protection throughout.
- SPARE TIRE/WHEEL: Full-size on C/K1500 only. Optional on C/K2500 and C/K3500.

- SPARE TIRE CARRIER: Winch-type mounted under frame at rear (C/K1500 only.)
- TIRES: Four steel-belted radial tires. (Tire size varies with model. See Wheels and Tires for details.)
- WHEELS: **Rally (except dual rear-wheel models.)** (Wheel size varies with model. See Wheels and Tires for details.)
- WHEEL OPENING FLARES: Black on K2500 C6P and K3500 models. (Dual rear-wheel models have front flares only).

INTERIOR

- ARMREST: RH and LH padded; integral with door panels.
- CIGARETTE LIGHTER.
- COAT HOOKS: **RH and LH coat hooks**.
- COLORS: Choice of five on reg. cabs and three on ext. cabs. See Color and Trim specifications for details.
- DOME LAMP: Switches in LH and RH door jams.
- DOOR PANELS: **Color-keyed** grained molded plastic with **soft vinyl trim, map pocket and Scottsdale emblems**.
- DOOR PILLAR AND ROOF SIDE PANELS: **Color-keyed**.
- DOOR SILL PLATE: **Color-keyed**.
- FLOOR COVERING: **Color-keyed** embossed rubber mat.
- GAGES: Including speedometer, odometer,

fuel level, voltmeter, temperature, oil pressure and additional telltale lights.

- GLOVE BOX: Latched door and beverage holder.
- HEADLINER: **Color-keyed cloth. Reg. cab and ext. cabs include matching retainer moldings**.
- HEATER: Deluxe with windshield and side window defoggers.
- INSULATION: Provided on dash panel, cowl top and sides, and doors. Ext. cabs have additional insulation on the rear quarter and back panels and on floor coverings, **plus insulation on headliners**. Extra insulation is provided with diesel engines.
- MIRROR: 10-inch rearview.
- RADIO: Manually-tuned AM radio with two 4" x 6" standard front dash speakers and a

fixed mast antenna. (Refer to the Delco Electronics brochure in RPO Detail for further information).

- STORAGE TRAY: **Full width behind seat on floor**.
- SEATS: 3-passenger **standard cloth trim** front bench with folding backrest.
- STEERING WHEEL: Custom urethane 4-spoke.
- SUNSHADES: **Color-keyed vinyl** RH and LH padded.
- TOOLS: Mechanical jack and wheel wrench located behind front seat or on rear compartment floor.
- TRIM PANELS: Ext. cabs have cab rear upper, lower and side trim panels.
- WINDOWS: Tinted glass.
- WINDSHIELD WIPERS: Intermittent.

CHEYENNE

(STANDARD)

The Cheyenne trim level is the standard trim level of the C/K series. It is designed to offer truck buyers a high level of standard features when they purchase a standard-level truck.

The following features are standard. Bold type denotes features in addition to or replacing that of the Work Truck trim.



Some equipment shown may be optional or extra cost.

POWERTRAIN/CHASSIS

- ALTERNATOR: 85 Amp Delcotron.
- BATTERY: Gas engines—12 volt, neg. ground; 630 CCA @ 0 degrees F. Diesel engines—Two 12 volt, neg. ground; 570 CCA @ 0 degrees F.
- BRAKES: Power; vacuum. Front—disc. Rear—drum. (except C/K3500) Includes rear wheel anti-lock braking system. C/K3500—Power; hydraulic. Front—disc. Rear—drum. Includes rear wheel anti-lock braking system.
- ENGINE: 4.3-liter V6 (EFI) on C/K1500 and 7200-lb. GVWR C/K2500. 160 net HP @ 4000 rpm and 235 lb. ft. of net torque @ 2400 rpm. Heavy-Duty 4.3-liter V6 EFI on C/K2500 at 8600-lb GVWR. 150 net HP @ 4000 rpm and 230 lb. ft. of net torque @ 2400 rpm. 6.2-liter V8 diesel, mechanical fuel injection, is available with B3J diesel

equipment (see Powertrains for details). 5.7-liter V8 EFI on C/K3500. 190 net HP @ 4000 rpm and 300 lb. ft. of net torque @ 2400 rpm.

- EXHAUST: Single.
- FRAME: All-welded ladder-type, channel design and boxed front-end section.
- FUEL TANK: 25.0-gallon (approx.) on C/K10703, C/K10753 and C/K20753. 34.0-gallon (approx.) on C/K10903, C/K10953, C/K20903, C/K20953 and C/K3500.
- REAR AXLE: Hypoid, Semi-Floating on C/K1500, and 2500. Standard axle ratio varies. Hypoid, Full-Floating type on C/K3500. Standard axle ratio varies.
- SHOCK ABSORBERS: —25 mm piston dia. front and rear on C/K1500. —32 mm piston dia. front on C/K2500 at 7200 lbs. GVWR and C/K3500. Also,

rear on C/K2500 and 3500.

- 35 mm piston dia. front on C/K2500 at 8600 lbs. GVWR.
- STABILIZER BAR: Front—1.25 inch diameter on 2-wheel drive models and 1.18 inch diameter on 4-wheel drive models.
- STEERING: Integral Power. Ratio—16/13:1.
- SUSPENSION: Front—Independent with computer-selected springs. Two-wheel drives with coil springs; four-wheel drives with torsion bars. Rear—Multi-Leaf springs; Semi-Elliptic two-stage on all models except C/K3500. Combined Semi-Elliptic two stage Main/Auxiliary on C/K3500.
- TOW HOOKS: Two front on 4-wheel drives.
- TRANSMISSION: Manual (4-speed or 5-speed depending on model; see Powertrains section for details).

EXTERIOR

- AIR DAM: Black. (Not included on models at or above 8600 lbs. GVWR).
- BUMPER: Chromed front (a rear bumper is available as an option only).
- COLORS: Choice of ten in a solid paint scheme. See Color and Trim specifications for details.
- GRILLE: Light argent molded plastic with dark argent air intake areas.
- HEADLAMPS: Single rectangular halogen.
- HORN: Single electric low-note.
- MIRRORS: Black RH and LH below-eye-

line type with adjustable heads. Head size is 9.0" x 6.5".

- NAMEPLATE: Cheyenne.
- PICKUP BOX: All-welded double wall construction and extensive corrosion protection throughout.
- SPARE TIRE/WHEEL: Full-size on C/K1500 only (optional on C/K2500 and 3500).
- SPARE TIRE CARRIER: Winch-type mounted under frame at rear on C/K1500 only.

- TIRES: Four steel-belted radials. (Tire size varies with model. See Wheels and Tires for details).
- TOW HOOKS: Two front on 4-wheel drives.
- WHEELS: Four silver painted steel wheels with black hub ornament. (Wheel size varies with model. See Wheels and Tires for details).
- WHEEL OPENING FLARES: Black on K2500 C6P and K3500. (Dual rear wheel models have front flares only).

INTERIOR

- ARMREST: RH and LH padded; integral with door panels.
- CIGARETTE LIGHTER.
- COAT HOOK: RH. Ext. cabs add a LH coat hook.
- COLORS: Choice of five on reg. cabs and three on ext. cabs. See Color and Trim specifications for details.
- DOME LAMP: Switch in LH door jamb.
- DOOR PANELS: Grained molded plastic.
- DOOR SILL PLATE: Gray.
- FLOOR COVERING: Embossed black rubber mat.
- GAGES: Including speedometer, odometer, fuel level, voltmeter, temperature, oil pressure and additional telltale lights.

- GLOVE BOX: Latched door and beverage holder.
- HEADLINER: Vinyl with matching retainer moldings.
- HEATER: Deluxe with windshield and side window defoggers.
- INSULATION: Provided on dash panel, cowl top and sides, and doors. Ext. cabs have additional insulation on the rear quarter and back panels and on floor coverings. Extra insulation is provided with diesel engines.
- MIRROR: 10-inch rearview.
- RADIO: Manually-tuned AM radio with two 4" x 6" standard front dash speakers and a fixed mast antenna. (Refer to

the Delco Electronics brochure in RPO Detail for further information).

- SEATS: 3-passenger all-vinyl trim front bench with folding backrest.
- STEERING WHEEL: Custom urethane 4-spoke.
- SUNSHADES: Color-keyed vinyl RH and LH padded.
- TOOLS: Mechanical jack and wheel wrench located behind front seat or on rear compartment floor.
- TRIM PANELS: Ext. cabs have rear upper, lower and side trim panels and a molded color-keyed cloth headliner with matching retaining moldings.
- WINDOWS: Tinted glass.

454 SS

(B4U)

The 454 SS is a 2-wheel drive sport truck package aimed specifically at the performance-minded buyer. It begins with Silverado trim and adds special performance equipment and features to create a unique-to-Chevrolet sport truck.

The following features are standard. Bold type denotes equipment in addition to or replacing that of the Silverado trim level.

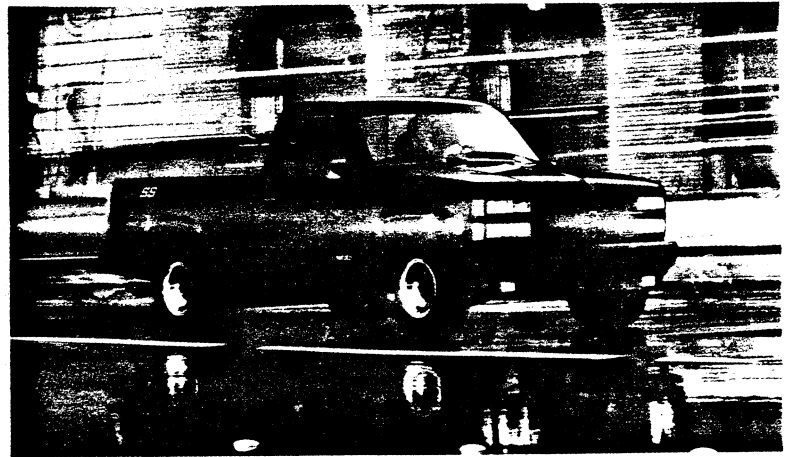

Some equipment shown may be optional or extra cost.

POWERTRAIN/CHASSIS

- ALTERNATOR: **100 amp Delcotron.**
- BATTERY: 12 volt, neg. ground; 630 CCA @ 0 degrees F.
- BRAKES: Power; vacuum. Front—disc. Rear—drum. Includes rear wheel anti-lock braking system.
- ENGINES: **7.4-liter V8 EFI. 230 net hp @ 3600 rpm and 385 lb. ft. of net torque @ 1600 rpm.**
- EXHAUST: **Dual—Pipes.**
- FRAME: All-welded ladder-type, channel design and boxed front-end section.
- FUEL TANK: 25.0-gallon (approx.).
- REAR AXLE: Hypoid, Semi-Floating with a **4.10 axle ratio.**
- SHOCK ABSORBERS: **46 mm piston dia. front and rear.**
- STABILIZER BAR: Front—1.25 inch dia.
- STEERING: Integral Power. **Ratio—12.7:1.**
- SUSPENSION: Front—Independent with computer-selected springs. Two-wheel drives with coil springs. Rear—Multi-Leaf springs; Semi-Elliptic two-stage.
- TRANSMISSION: **Heavy-Duty 4-speed automatic with overdrive.**

EXTERIOR

- AIR DAM: Black with fog lamps.
- BUMPER: **Black front and rear with rub strips.**
- COLORS: **Onyx black** in a solid paint scheme.
- DECALS: **Sport identification.**
- EXTERIOR TRIM: **Blackout.**
- GRILLE: **Blackout.**
- HEADLAMPS: Composite halogen.
- HORN: Dual low- and high-note.
- MIRRORS: Black RH and LH fixed with adjustable heads. **Head size is 6.0" x 4.5".**
- MOLDINGS: Black body side.
- PICKUP BOX: All-welded **6.5-foot**, double wall construction and extensive corrosion protection throughout.
- SPARE TIRE/WHEEL: Full-size.
- SPARE TIRE CARRIER: Winch-type mounted under frame at rear.
- TIRES: Four **P275/60R15AS** steel-belted radials.
- WHEELS: **15.0" x 7.0" Chrome Styled.**

INTERIOR

- AIR CONDITIONING.
- AUXILIARY LIGHTING: Includes dome and reading, courtesy, ashtray, glove box, cargo area and underhood lamps.
- ARMREST: RH and LH padded; integral with door panels.
- CAB BACK PANELS: Color-keyed carpet and insulation.
- CIGARETTE LIGHTER.
- COAT HOOK: RH and LH.
- COLORS: **Garnet Custom Cloth.**
- COMFORTILT STEERING.
- DOME LAMP: Switches in LH and RH door jambs.
- DOOR PANELS: Two-toned soft vinyl over plastic trim and includes map pocket, door closing assist straps, and Silverado emblems.
- DOOR PILLAR AND ROOF SIDE PANELS: Color-keyed.
- DOOR SILL PLATE: Color-keyed.
- ELECTRONIC SPEED CONTROL.
- FLOOR COVERING: Color-keyed carpeting.
- FLOOR MATS: Front removable color-keyed.
- GAGES: Including speedometer, odometer, fuel level, **tachometer**, fuel level, voltmeter, temperature, oil pressure and additional telltale lights.
- GLOVE BOX: Latched door and beverage holder.
- HEADLINER: Color-keyed cloth. Includes matching retainer moldings.
- HEATER: Deluxe with windshield and side window defoggers.
- INSULATION: Provided on dash panel, cowl top and sides, doors, headliners, and on back panels.
- POWER DOOR LOCKS.
- POWER WINDOWS.
- RADIO: Electronically-tuned AM /FM stereo radio with seek-scan, **stereo cassette tape with search and repeat, graphic equalizer and digital clock. Includes four 4" x 6" extended range speakers—two located in the front dash and two located in the rear above the door. (Refer to the Delco Electronics brochure in RPO Detail for further information).**
- SEATS: **Reclining, high-back bucket seats with console. In Garnet Custom Cloth only.**
- STEERING WHEEL: Sport urethane 4-spoke.
- STORAGE TRAY: Full width behind seat on floor.
- SUNSHADES: Color-keyed RH and LH padded with cloth covering, storage strap on LH unit and visor mirror on RH unit.
- TOOLS: Mechanical jack and wheel wrench located behind front seat or on rear compartment floor.
- WINDOWS: Tinted glass. **Includes sliding rear.**
- WINDSHIELD WIPERS: Intermittent.

SILVERADO

(YE9)

The Silverado trim level is an optional trim level for the C/K series. It is designed to offer truck buyers an increased level of comfort and convenience features compared to the standard Cheyenne and the optional Scottsdale trim levels.

The following features are standard. Bold type denotes equipment in addition to or replacing that of the Scottsdale trim level.



Some equipment shown may be optional or extra cost.

POWERTRAIN/CHASSIS

- ALTERNATOR: 85 Amp Delcotron.
- BATTERY: Gas engines—12 volt, neg. ground; 630 CCA @ 0 degrees F. Diesel engines—Two 12 volt, neg. ground; 570 CCA @ 0 degrees F.
- BRAKES: Power; vacuum. Front—disc. Rear—drum. (except C/K3500). Includes rear wheel anti-lock. Power; hydraulic. Front—disc. Rear—drum. (C/K3500 series only). Includes rear wheel anti-lock braking system.
- ENGINE: 4.3-liter V6 EFI on C/K1500 and 7200-lb. GVWR C/K2500. 160 net HP @ 4000 rpm and 235 lb. ft. of net torque @ 2400 rpm. Heavy-Duty 4.3-liter V6 EFI on C/K2500 8600-lb. GVWR. 150 net HP @ 4000 rpm and 230 lb. ft. of net torque @ 2400 rpm. 6.2-liter V8 diesel with mechanical fuel injection is available with B3J diesel equip. (see Powertrains for details).

- 5.7-liter V8 EFI on C/K3500. 190 net HP @ 4000 rpm and 300 lb. ft. of net torque @ 2400 rpm.
- EXHAUST: Single.
- FRAME: All-welded ladder-type, channel design and boxed front-end section.
- FUEL TANK: 25.0-gallon (approx.) on C/K10703, and C/K10753 and C/K20753. 34.0-gallon (approx.) on C/K10903, C/K10953, C/K20903, C/K20953 and C/K3500.
- REAR AXLE: Hypoid, Semi-Floating on C/K1500, and 2500. Standard axle ratio varies. Hypoid, Full-Floating on C/K3500 series. Standard axle ratios vary.
- SHOCK ABSORBERS: —25 mm piston dia. front and rear on C/K1500. —32 mm piston dia. front on C/K2500 at 7200 lbs. GVWR and C/K3500. Also, rear on C/K2500 and 3500.

- 35 mm piston diameter front on C/K2500 at 8600 lbs. GVWR.
- STABILIZER BAR: Front—1.25 inch diameter on 2-wheel drive models and 1.18 inch diameter on 4-wheel drive models
- STEERING: Integral Power. Ratio—16/13:1.
- SUSPENSION: Front—Independent with computer-selected springs. Two-wheel drive models with coil springs; four-wheel drive models with torsion bars. Rear—Multi-Leaf springs; Semi-Elliptic two-stage on C/K models except C/K3500. Combined Semi-Elliptic two-stage Main/Auxiliary on C/K3500.
- TOW HOOKS: Two front on 4-wheel drives.
- TRANSMISSION: Manual (4-speed or 5-speed depending on model. See Powertrains section for details).

EXTERIOR

- AIR DAM: Black. (Not included on model at or above 8600 lbs. GVWR).
- BUMPER: Chromed front with black strip and bright trim.
- COLORS: Choice of ten in a solid paint scheme. See Color and Trim specifications for details.
- GRILLE: Deluxe dark argent grille with bright trim.
- HEADLAMPS: Composite halogen.
- HORN: Dual low- and high-note.
- INSULATION: Hood and cab-to-fender.

- MOLDINGS: Black body side with bright trim and bright wheel opening (except K2500 C6P, K3500, and Sportside models.)
- MIRRORS: Black RH and LH below-eye-line type with adjustable heads. Head size is 9.0" x 6.5".
- NAMEPLATES: Silverado.
- PICKUP BOX: All-welded double wall construction and extensive corrosion protection throughout.
- SPARE TIRE/WHEEL: Full-size on C/K1500 only. (Optional on C/K2500 and 3500).

- SPARE TIRE CARRIER: Winch-type mounted under frame at rear. (C/K1500 only).
- TIRES: Four steel-belted radials. Tire size varies with model. (See Wheels and Tires for details).
- WHEELS: Rally (except dual rear-wheel models.) (Wheel size varies with model. See Wheels and Tires for details).
- WHEEL OPENING FLARES: Black on K2500 C6P and K3500. (Dual rear-wheel models have front flares only).
- WINDOWS: Swing-out rear quarter windows on ext. cabs.

INTERIOR

- ARMREST: RH and LH padded; integral with door panels.
- CAB BACK PANELS: Color-keyed carpet.
- CIGARETTE LIGHTER.
- COAT HOOKS: RH and LH.
- COLORS: Choice of five on reg. cabs and three on ext. cabs. See Color and Trim specifications for details.
- DOME LAMP: Switches in LH and RH door jambs.
- DOOR PANELS: Two-toned soft vinyl over plastic trim and includes map pocket, door closing assist straps and Silverado emblems.
- DOOR PILLAR AND ROOF SIDE PANELS: Color-keyed.
- DOOR SILL PLATE: Color-keyed.
- FLOOR COVERING: Color-keyed carpeting.
- FLOOR MATS: Front and rear removable color-keyed (front only on regular cab.)
- GAGES: Including speedometer, odometer, fuel level, voltmeter, temperature, oil pressure and additional telltale lights.

- GLOVE BOX: Latched door and beverage holder.
- HEADLINER: Color-keyed cloth. Reg. and ext. cabs include matching retainer moldings.
- HEATER: Deluxe with windshield and side window defoggers.
- INSULATION: Provided on the dash panel, cowl top and sides, and doors. Ext. cabs have additional insulation on the rear quarter and back panels and on floor coverings, plus insulation on headliners and on reg. cab back panels. In addition, diesel engines are provided with extra insulation.
- MIRROR: 10-inch rearview mirror.
- RADIO: Electronically-tuned AM/FM stereo radio with seek-scan and digital clock. Includes two 4" x 6" front dash standard speakers and two 4" x 6" rear extended range speakers located to the rear above the door. (Refer to the Delco Electronics brochure in RPO Detail for further information).

- SEATS: 3-passenger front bench with choice of Custom Vinyl or Custom Cloth with folding backrest. (Ext. cabs offer a choice of Custom Vinyl or Custom Cloth split front bench seat with RH easy-entry feature).
- STEERING WHEEL: Sport urethane 4-spoke.
- STORAGE TRAY: Full width behind seat on floor.
- SUNSHADES: Color-keyed RH and LH padded with cloth covering, storage strap on LH unit and visor mirror on RH unit.
- TOOLS: Mechanical jack and wheel wrench located behind front seat or on rear compartment floor.
- TRIM PANELS: Ext. cabs have cab rear upper, lower and side trim panels.
- WINDOWS: Tinted glass.
- WINDSHIELD WIPERS: Intermittent.

Y: S Standard O Optional
 — Not Offered H High Altitude Emissions only. Red Print Not Available w/California Emissions.
 Bold Print Not Available w/High Altitude Emissions.

MODEL	ENGINE	TRANSMISSION			AXLES					GVWR
		(MM4) MANUAL 4-SPEED	(MM5) MANUAL 5-SPEED	(MX0) AUTO 4-SPEED	ECONOMY		POWER			
					3.08	3.42	3.73	4.10	4.56	
TWO-WHEEL DRIVE MODELS										
C2500 EXTENDED CAB FLEETSIDE CC20753/E63 CC20953/E63	7.4L V8 (L19)	S	—	—	—	S	O	O ¹	—	8600 (C6P)
	6.2L V8 (LH6) DIESEL	S	—	—	—	S	O ⁴	H	—	7200
	6.2L V8 (LL4) DIESEL	S	—	—	—	—	S	O	—	8600 ⁸ (C6P)
C3500 REGULAR CAB BIG DOOLEY CC30903/E63 (R05)	5.7L V8 (L05)	S	—	—	—	—	—	S ¹	O ¹	10,000
	7.4L V8 (L19)	S	—	—	—	—	S	O ¹	O ¹	10,000
	6.2L V8 (LL4) DIESEL	S	—	—	—	—	—	S	O ³	10,000
C3500 EXTENDED CAB BIG DOOLEY CC30953/E63 (R05)	5.7L V8 (L05)	S	—	—	—	—	—	S ¹	O ¹	10,000
	7.4L V8 (L19)	S	—	—	—	—	S ²	O ²	O ^{1.7}	10,000
	6.2L V8 (LL4) DIESEL	S	—	—	—	—	—	S ²	O ^{2.7}	10,000

FOUR-WHEEL DRIVE MODELS

K1500 REGULAR CAB SPORTSIDE CK10703/E62	4.3L V6 (LB4)	O	—	—	—	S ¹¹	O ¹	—	—	5600/ 6100 ⁹
		—	S	—	—	S ¹¹	O ¹	—	—	
		—	—	O	—	S ¹¹	O ¹	—	—	
K1500 REGULAR CAB FLEETSIDE CK10703/E63	5.0L V8 (L03)	—	S	—	—	S ¹¹	O	—	—	5600/ 6100 ^{9,9}
		—	—	O ⁵	—	S ¹¹	O	—	—	
		O	—	—	—	S	O ¹	—	—	5600/ 6100 ⁹
K1500 REGULAR CAB FLEETSIDE CK10903/E63	4.3L V6 (LB4)	—	S	—	—	S ¹¹	O ¹	—	—	5600/ 6100 ⁹
		—	—	O	—	S ¹¹	O ¹	—	—	
		O ¹⁰	—	—	—	S ¹¹	O ¹	—	—	
	5.0L V8 (L03)	—	S	—	—	S ¹¹	O ⁵	—	—	5600/ 6100 ⁹
		—	—	O ⁵	—	S ¹¹	O ⁶	—	—	
		O	—	—	—	S	O ¹	—	—	5600/ 6100 ⁹
	5.7L V8 (L05)	—	S	—	—	S	O ¹	—	—	5600/ 6100 ⁹
		—	—	O	—	S	O ¹	—	—	
		—	—	—	—	S	O ¹	H ^{1.8}	—	
	6.2L V8 (LH6) DIESEL	S	—	—	—	S ¹¹	O	—	—	6100
		—	—	O	—	S ¹¹	O ¹	—	—	
		—	—	—	—	S ¹¹	O ¹	—	—	
K1500 EXTENDED CAB FLEETSIDE CK10753/E63 CK10953/E63	4.3L V6 (LB4)	O	—	—	—	S ¹¹	O ¹	—	—	6200/ 6600 ⁹
		—	S	—	—	S ¹¹	O ¹	—	—	
		—	—	O	—	S ¹¹	O ¹	—	—	
	5.0L V8 (L03)	—	S	—	—	S ¹¹	O ¹	—	—	6200/ 6600 ⁹
		—	—	O ⁵	—	S ¹¹	O ¹	H ^{1.8}	—	
		O	—	—	—	S	O ¹	—	—	6200/ 6600 ⁹
	5.7L V8 (L05)	—	S	—	—	S	O ¹	—	—	6600
		—	—	O	—	S	O ¹	H ^{1.8}	—	
		—	—	—	—	S ¹¹	O	—	—	
6.2L V8 (LH6) DIESEL	S	—	—	—	S ¹¹	O	—	—	6600	
	—	—	O	—	S ¹¹	O	—	—		
	—	—	—	—	S ¹¹	O	—	—		
K2500 REGULAR CAB FLEETSIDE CK20903/E63	4.3L V6 (LB4)	O	—	—	—	S	O ¹	—	—	7200
		—	S	—	—	S	O ¹	—	—	
		—	—	O	—	S	O ^{1.4}	O ¹	—	8600 (C6P)
	5.0L V8 (L03)	—	—	O	—	—	—	—	S ¹	7200
		—	S	—	—	S	O	—	—	
		—	—	O ⁵	—	S	O ⁶	O ⁶	—	8600 (C6P)
	7.4L V8 (L19)	S	—	—	—	S	O	O ¹	—	8600 (C6P)
		—	—	O	—	—	S	O ¹	—	
		—	—	—	—	—	—	—	—	

¹Requires KC4 Engine Oil Cooler.
²Requires V02 H.D. Cooling.
³Requires KC4 and V02 Cooling.
⁴Standard with High Altitude Emissions.

⁵Standard with California Emissions.
⁶With C60 Air Req. KC4.
⁷Requires 7.50-16D Tires.
⁸N/A C/K20753 Models.

⁹Requires F44 H.D. Chassis.
¹⁰N/A with RPO VLA.
¹¹N/A with LT265/75R16C Tires.

¹²California Requires V02 Cooling.
¹³454SS Model only.

KEY: S Standard O Optional Red Print Not Available w/California Emissions.
 — Not Offered H High Altitude Emissions only. Bold Print Not Available w/High Altitude Emissions.

MODEL	ENGINE	TRANSMISSION			AXLES					GVWR
		(MM4) MANUAL 4-SPEED	(MM5) MANUAL 5-SPEED	(MX0) AUTO 4-SPEED	ECONOMY		POWER			
					3.08	3.42	3.73	4.10	4.56	
TWO-WHEEL DRIVE MODELS										
C1500 REGULAR CAB SPORTSIDE CC10703/E62	4.3L V6 (LB4)	—	S	—	S	O	—	—	—	5600
	5.0L V8 (L03)	—	—	O	S	O ⁴	H ³	—	—	5600
		—	S	—	S	O	—	—	—	
	C1500 REGULAR CAB FLEETSIDE CC10703/E63	5.7L V8 (L05)	—	S	—	S	O	—	—	—
7.4L V8 (L19)¹³		—	—	O	S	O	O ²	—	—	5600
	—	—	S	—	—	—	S	—		
C1500 REGULAR CAB FLEETSIDE CC10903/E63	4.3L V6 (LB4)	O ¹⁰	—	—	S	O	—	—	—	5600/
		—	S	—	S	O	—	—	—	6100 ⁹
	5.0L V8 (L03)	—	—	O	S	O ⁴	H ²	—	—	5600/
		—	S	—	S	O	—	—	—	
	5.7L V8 (L05)	O	—	—	S	O	—	—	—	5600/
		—	S	—	S	O	—	—	—	6100 ⁹
6.2L V8 (LH6) DIESEL	S	—	—	S	O	O ²	—	—	6100	
	—	—	O	S	O	H	—	—		
C1500 EXTENDED CAB FLEETSIDE CC10753/E63 CC10953/E63	4.3L V6 (LB4)	O	—	—	S	O ⁴	—	—	—	6200
		—	S	—	S	O	—	—	—	
	5.0L V8 (L03)	—	S	—	S	O ⁴	H ¹	—	—	6200
		—	—	O ⁵	S	O	—	—	—	
	5.7L V8 (L05)	O	—	—	S	O	—	—	—	6200
		—	S	—	S	O	—	—	—	
6.2L V8 (LH6) DIESEL	S	—	—	S	O	O ¹	—	—	6200	
	—	—	O	S	O	H	—	—		
C2500 REGULAR CAB FLEETSIDE CC20903/E63	4.3L V6 (LB4)	O	—	—	—	S	O ^{1,4}	—	—	7200
		—	S	—	—	S	O ^{1,4}	—	—	
		—	—	O	—	S	O ^{1,4}	O ¹	—	
	5.0L V8 (L03)	—	—	O	—	—	—	—	S ¹	8600 (C6P)
		—	S	—	—	—	—	—	S ¹	
	5.7L V8 (L05)	—	—	O ⁵	—	S	O ⁶	O ⁶	—	7200
		O	—	—	—	S	O ¹	—	—	
	7.4L V8 (L19)	—	S	—	—	S	O ¹	—	—	8600 (C6P)
		—	—	O	—	S	O ³	O ³	—	
		—	—	O	—	S	O ¹	O ¹	—	
	6.2L V8 (LH6) DIESEL	S	—	—	—	S	O ²	H	—	7200
		—	—	O	—	S	O	—	—	
6.2L V8 (LL4) DIESEL	S	—	—	—	—	S	O	—	8600 (C6P)	
	—	—	O	—	—	S	O	O		
C2500 EXTENDED CAB FLEETSIDE CC20753/E63 CC20953/E63	4.3L V6 (LB4)	O	—	—	—	S	O ^{1,4}	—	—	7200
		—	S	—	—	S	O ^{1,4}	—	—	
		—	—	O	—	S	O ^{3,4}	O ³	—	
	5.0L V8 (L03)	—	—	O ²	—	—	—	—	S	8600 ⁸ (C6P)
		—	S	—	—	—	—	—	S	
	5.7L V8 (L05)	—	—	O ⁵	—	S	O ⁶	O ⁶	—	7200
		O	—	—	—	S	O ¹	—	—	
	7.4L V8 (L19)	—	S	—	—	S	O ¹	—	—	8600 ⁸ (C6P)
—		—	O	—	S	O ³	O ³	—		
—		—	O ²	—	—	S	O	O		

¹Requires KC4 Engine Oil Cooler.
²Requires V02 H.D. Cooling.
³Requires KC4 and V02 Cooling.
⁴Standard with High Altitude Emissions.

⁵Standard with California Emissions.
⁶With C60 Air Req. KC4.
⁷Requires 7.50-16D Tires.
⁸N/A C/K20753 Models.

⁹Requires F44 H.D. Chassis.
¹⁰N/A with RPO VLA.
¹¹N/A with LT265/75R16C Tires.

¹²California Requires V02 Cooling.
¹³454SS Model only.

HORSEPOWER AND TORQUE RATINGS

ENGINE	4.3L V6		5.0L V8	5.7L V8		7.4L V8		6.2L V8 DIESEL	
RPO CODE	LB4	LB4	L03	L05	L05	L19	L19	LH6	LL4
RESTRICTIONS	Below 8600 Lbs. GVWR	8600 Lbs. GVWR	Up to 7200 Lbs. GVWR	Below 8600 Lbs. GVWR	8,600-10,000 Lbs. GVWR	8,600-10,000 Lbs. GVWR	454 SS Only	GVWR Below 8600 Lbs. GVWR	8600-10,000 Lbs. GVWR
CHART REFERENCE CODE	A	B	C	D	E	F	G	H	I
SAE NET HORSEPOWER Horsepower @ RPM	160 @ 4000	155 @ 4000	175 @ 4000	210 @ 4000	190 @ 4000	230 @ 3600	255 @ 4000	140 @ 3600	150 @ 3500
SAE NET TORQUE Lb. Ft. @ RPM	235 @ 2400	230 @ 2400	270 @ 2400	300 @ 2800	300 @ 2400	385 @ 1600	405 @ 2400	255 @ 1900	280 @ 2000
FUEL SYSTEM	EFI	EFI	EFI	EFI	EFI	EFI	EFI	Gear Driven Mechanical Fuel Injection	Gear Driven Mechanical Fuel Injection
CLUTCH SIZE (in.)	11	11	11	12	12	12	12	12	12
STD. BATTERY (Cold Cranking Amps @ 0°F)	630	630	630	630	630	630	630	2 @ 570 Ea.	2 @ 570 Ea.

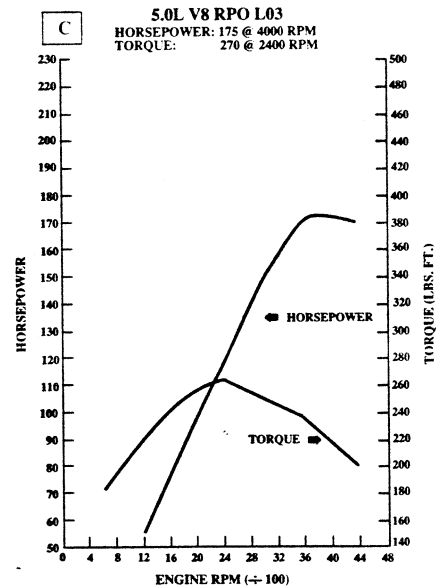
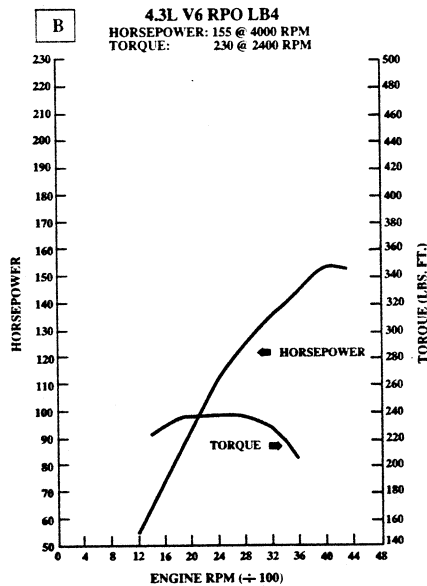
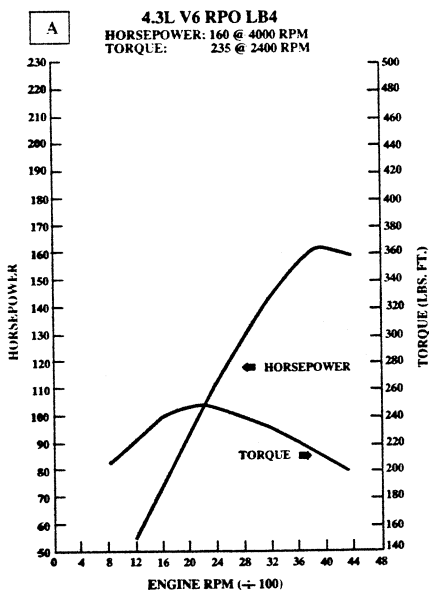

KEY: S Standard O Optional Red Print Not Available w/California Emissions.
 — Not Offered H High Altitude Emissions only. Bold Print Not Available w/High Altitude Emissions.

MODEL	ENGINE	TRANSMISSION			AXLES					GVWR
		(MM4) MANUAL 4-SPEED	(MM5) MANUAL 5-SPEED	(MX0) AUTO 4-SPEED	ECONOMY		POWER			
					3.08	3.42	3.73	4.10	4.56	
FOUR-WHEEL DRIVE MODELS										
K2500 REGULAR CAB FLEETSIDE CK20903/E63	5.7L V8 (L05)	O	—	—	—	S	O ¹	—	—	7200
		—	S	—	—	S	O ¹	—	—	
		—	—	O	—	S	O ¹	O ¹	—	
	6.2L V8 (LH6) DIESEL	—	—	—	—	S	O	—	—	7200
		S	—	—	—	S	O	O	—	
	6.2L V8 (LL4) DIESEL	—	—	—	—	—	S	O	—	8600 (C6P)
		—	—	O	—	—	S	O	O	
K2500 EXTENDED CAB FLEETSIDE CK20753/E63 ¹² CK20953/E63	4.3L V6 (LB4)	O	—	—	—	S	O ¹	—	—	7200
		—	S	—	—	S	O ¹	—	—	
		—	—	O	—	S	O ^{1,4}	O ¹	—	
	5.0L V8 (L03)	—	—	—	—	—	—	—	S	8600 ⁶ (C6P)
		—	S	—	—	S	O	—	—	
	5.7L V8 (L05)	—	—	O ⁵	—	S	O ⁶	O ⁶	—	7200
		O	—	—	—	S	O ¹	—	—	
		—	S	—	—	S	O ¹	—	—	
	S	—	—	—	—	S	O	O	—	8600 ⁶ (C6P)
		—	—	O ²	—	—	S	O	O	
	7.4L V8 (L19)	S	—	—	—	S	O	O ¹	—	8600 (C6P)
		—	—	O	—	—	S	O ¹	—	
	6.2L V8 (LH6) DIESEL	S	—	—	—	S	O	—	—	7200
		—	—	O	—	S	O	O	—	
	6.2L V8 (LL4) DIESEL	S	—	—	—	—	S	O	—	8600 ⁶ (C6P)
—		—	O	—	—	S	O	O		
K3500 REGULAR CAB BIG DOOLEY CK30903/E63 (R05)	5.7L V8 (L05)	S	—	—	—	—	—	S ¹	O ¹	10,000
		—	—	O	—	—	—	S ³	O ¹	
	7.4L V8 (L19)	S	—	—	—	—	S	O ¹	O ¹	10,000
		—	—	O	—	—	S	O ³	O ^{1,7}	
	6.2L V8 (LL4) DIESEL	S	—	—	—	—	—	S	O	10,000
		—	—	O	—	—	—	S	O ⁷	
K3500 EXTENDED CAB BIG DOOLEY CK30953/E63 (R05)	5.7L V8 (L05)	S	—	—	—	—	—	S ¹	O ¹	10,000
		—	—	O	—	—	—	S ³	O ¹	
	7.4L V8 (L19)	S	—	—	—	—	S	O ¹	O ⁷	10,000
		—	—	O	—	—	S	O ³	O ^{1,7}	
	6.2L V8 (LL4) DIESEL	S	—	—	—	—	—	S	O	10,000
		—	—	O	—	—	—	S	O ⁷	

¹Requires KC4 Engine Oil Cooler.
²Requires V02 H.D. Cooling.
³Requires KC4 and V02 Cooling.
⁴Standard with High Altitude Emissions.

⁵Standard with California Emissions.
⁶With C60 Air Req. KC4.
⁷Requires 7.50-16D Tires.
⁸N/A C/K20753 Models.

⁹Requires F44 H.D. Chassis.
¹⁰N/A with RPO VLA.
¹¹N/A with LT265/75R16C Tires.

¹²California Requires V02 Cooling.
¹³454SS Model only.

TRANSMISSION		MANUAL			AUTOMATIC	
TRANSMISSION MODEL	4-SPEED SM465	5-SPEED w/OVERDRIVE	HEAVY-DUTY w/OVERDRIVE NP4500 ¹	4-SPEED w/OVERDRIVE 4L80-E	4-SPEED w/OVERDRIVE 4L60	
RPO CODE	MM4	MM5	MM5	MX0	MX0	
SYNCHRONIZED SPEEDS	2/3/4	1/2/3/4/5	1/2/3/4/5	—	—	
GEAR RATIOS						
First	6.55	4.02	6.34	2.48	3.06	
Second	3.58	2.32	3.44	1.48	1.63	
Third	1.70	1.40	1.71	1.00	1.00	
Fourth	1.00	1.00	1.00	.75	.70	
Fifth	—	.73	.73	—	—	
Reverse	6.09	3.74	6.34	2.08	2.29	
GEAR TYPE				Planetary	Planetary	
Forward	Helical	Helical	Helical			
Reverse	Spur	Spur	Spur			
Center Distance (in.)	117	85	109			
TORQUE CONVERTER				Pump/Stator/ Turbine Automatic	Pump/Stator/ Turbine Automatic	
Element Types	—	—	—			
Lock-up Clutch						
POWER TAKE-OFF						
Opening Type	SAE Std. 6-Bolt	—	SAE Std. 6-Bolt	—	—	
Location	Both Sides ²		Both Sides ²			
Drive Gear	3rd Speed Counter Gear		3rd Speed Counter Gear			
PTO Gear RPM						
@1000 Engine RPM	425		425			
PTO Pitch Line Velocity						
@ 1000 Engine RPM	560ft./minute		560ft./minute			
LUBRICANT CAPACITY (pints)						
Oil	8	3.7	8.5	13.5	19	
Refill	—	—	—	6	10	

¹Interim availability only. Will replace the 4-speed manual, model SM 465 in certain applications. Please check your order guide for availability.
²Left hand side PTO not accessible on 4-wheel drive models.

TRANSFER CASE		
TRANSFER CASE MODEL	NEW PROCESS 241	BORG WARNER 1370
MODEL AVAILABILITY	K1500/2500	K3500
RATIOS: Hi Range	1.00:1	100:1
Lo Range	2.72:1	2.69:1
LEVER POSITIONS	4-Lo (All-wheel Underdrive) N (Neutral) 2-Hi (Rear-wheel Drive) 4-Hi (All-wheel Drive)	4-Lo (All-wheel Underdrive) N (Neutral) 2-Hi (Rear-wheel Drive) 4-Hi (All-wheel Drive)
LEVER LOCATION	Rear of Transmission at Center of Floor	Rear of Transmission at Center of Floor
POWER TAKE-OFF DATA		
Opening	—	SAE Std. 6 Bolt
Location	—	Right Hand Side
OIL CAPACITY (pints)	4.6	3.1

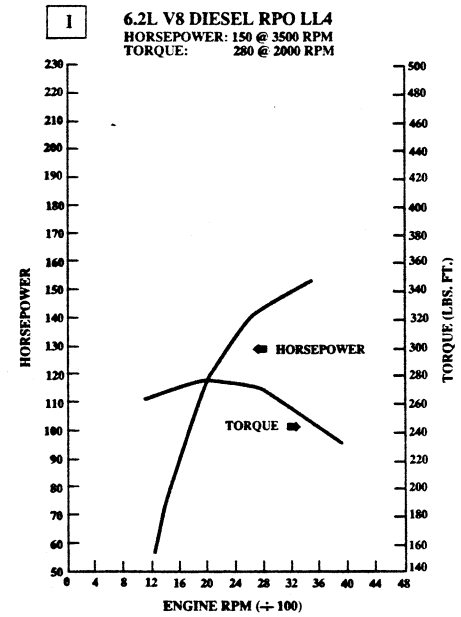
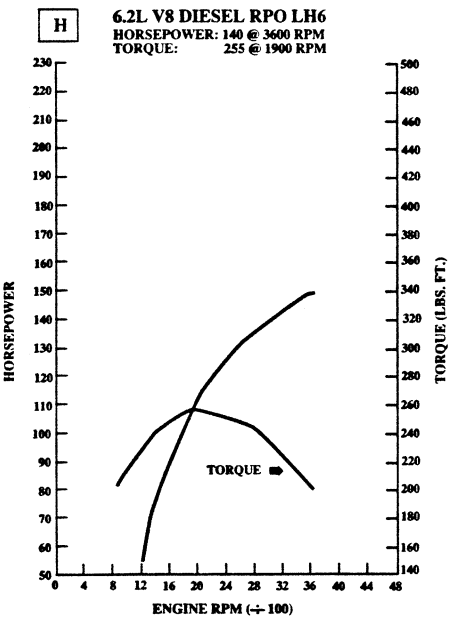
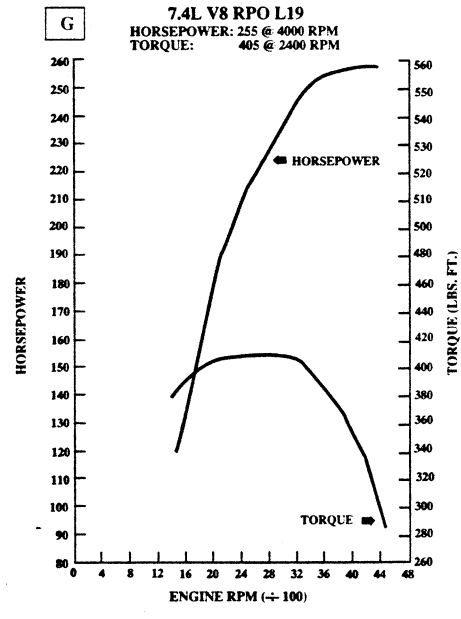
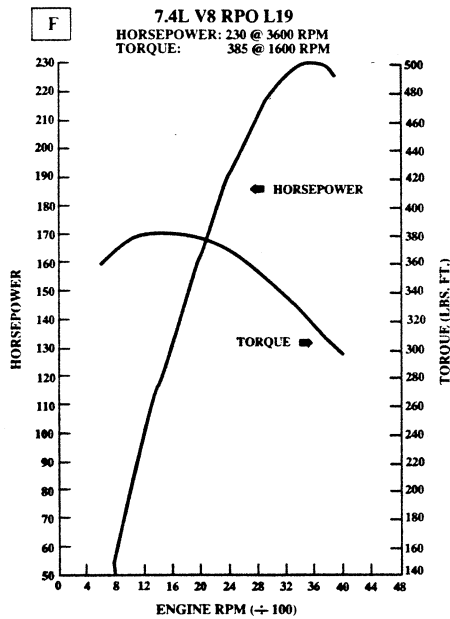
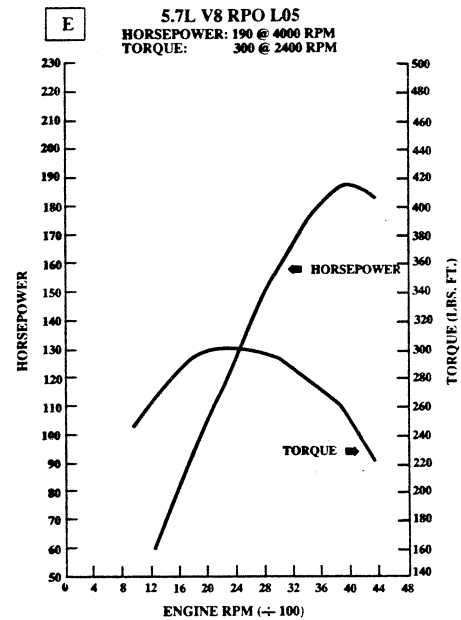
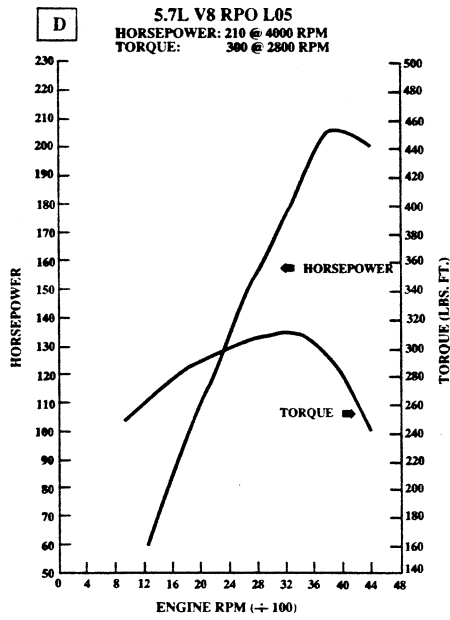

TWO-WHEEL DRIVE MODELS

MODEL	C1500 REG. CAB SPORTSIDE/FLEETSIDE		C1500 REG. CAB FLEETSIDE		C1500 EXT. CAB FLEETSIDE		C2500 REG. CAB FLEETSIDE		C2500 EXT. CAB FLEETSIDE		C3500 REG. CAB FLEETSIDE		C3500 EXT. CAB FLEETSIDE	
	MODEL NUMBER		CC10903/E63		CC10753/E63 CC10953/E63		CC20903/E63		CC20753/E63 CC20953/E63		CC30903/E63		CC30953/E63	
		GAS	B3J	GAS	B3J	GAS	B3J	GAS	B3J	GAS	B3J	GAS	B3J	

STANDARD SUSPENSION

PAYLOAD (Maximum lbs.)	1879	1899	1762	1741	2150	1612	3198		3039	2217	5055	5110	4757	4458
GVWR (lbs.)	5600		5600	6100	6200		7200		7200		10,000		10,000	
GAWR (lbs.) Front	2950		2950	3150	3500		3150	3400	3600		3600		3600	
Rear	3404		3404	3686	3686		4670	4670	7500		7500			
FRONT SUSPENSION Type	Independent Coil Spring		Independent Coil Spring		Independent Coil Spring		Independent Coil Spring		Independent Coil Spring		Independent Coil Spring		Independent Coil Spring	
Standard Spring Capacity Total (lbs.)	2950		2950	3200	3500		3150	3400	3600		3600		3600	
Front Shock Absorbers Piston Diameter (mm) Std/Opt	25/32 ²		25/32 ²		25/32 ²		32/—		32/—		32/—		32/—	
Front Stabilizer Bar Diameter (in.) Std/Opt	1.25		1.25		1.25		1.25		1.25		1.25		1.25	
REAR SUSPENSION Type	Semi-Elliptic 2-Stage Multi-Leaf Spring		Semi-Elliptic 2-Stage Multi-Leaf Spring		Semi-Elliptic 2-Stage Multi-Leaf Spring		Semi-Elliptic 2-Stage Multi-Leaf Spring		Semi-Elliptic 2-Stage Multi-Leaf Spring		Comb. Semi-Elliptic 2-Stage Main/Aux.		Comb. Semi-Elliptic 2-Stage Main/Aux.	
Standard Spring Cap. Total (lbs.)	3750		3750		3750		4800		4800		7500		7500	
Leaves Per Spring	4		4		4		5		5		6/1		6/1	
Leaf Thickness (in.)	2.14		2.14		2.14		2.71		2.71		4.86		4.86	
Rear Shock Absorber Piston Diameter (mm) Std/Opt	25/32 ²		25/32 ²		25/32 ²		32/—		32/—		32/—		32/—	
FRONT AXLE Type	—		—		—		—		—		—		—	
Make	—		—		—		—		—		—		—	
Maximum Capacity (lbs.)	2950		2950	3150	3600		3150	3400	3600		3800		3800	
Standard Hub Locks	—		—		—		—		—		—		—	
Pinion/Ring Gear Type	—		—		—		—		—		—		—	
REAR AXLE Type	Semi-Floating GM		Semi-Floating GM		Semi-Floating GM		Semi-Floating GM		Semi-Floating GM		Full-Floating GM		Full-Floating GM	
Make	GM		GM		GM		GM		GM		GM		GM	
Maximum Capacity (lbs.)	3750		3750		3750		4800		4800		7500		7500	
Pinion/Ring Gear Type	Hypoid		Hypoid		Hypoid		Hypoid		Hypoid		Hypoid		Hypoid	
STANDARD TIRES Front/Rear	Tubeless SBR P225/75R15 BW		Tubeless SBR P225/75 R15 BW P235/75 R15 BW		Tubeless SBR P235/75R15 BW		Tubeless SBR LT225/75R16D BW		Tubeless SBR LT225/75R16D BW		Tubeless SBR LT225/75R16-C/D BW		Tubeless SBR LT225/75R16-C/D BW	
Tire Capacity (lbs.) each	1703		1703	1843	1843		2335		2335		1940/2150		1940/2150	
Inflation (psi) max.	35		35	35	35		65		65		50/55		55	
Revolutions per mile @ 45 mph	737		737	722	722		706		706		704/706		704/706	
WHEELS Size	15.0 x 6.0		15.0x6.0	15.0x7.0	15.0 x 7.0		16.0 x 6.5		16.0 x 6.5		16.0 x 6		16.0 x 6	
Capacity (lbs.) each	1702		1702	1843	1843		2400		2400		2400		2400	
Bolt Holes	5		5	5	5		6		6		8		8	
Bolt Circle Diameter (in.)	5		5	5	5		5.5		5.5		6.5		6.5	
Offset (mm)	0		0	13	13		13		13		127		127	

Based on Curb Weight. ² 46mm shocks with ZQ8 Sport Handling Package.

REAR AXLES																				
AXLE MAKE AND CAPACITY (lbs.)	GM 3750					GM 4800			GM 6000				GM 6000 Full-Floating			GM 7500 Full-Floating				
PINION & RING GEAR Type	Hypoid					Hypoid			Hypoid				Hypoid			Hypoid				
	Ratio	2.73	3.08	3.42	3.73	4.10	3.42	3.73	4.10	3.42	3.73	4.10	4.56	3.42	3.73	4.10	3.42	3.73	4.10	4.56
	Pinion Teeth	15	13	12	11	10	12	11	10	12	11	10	9	12	11	10	12	11	10	9
	Ring Gear Teeth	41	41	41	41	41	41	41	41	41	41	41	41	41	41	41	41	41	41	41
	Ring Gear Dia. (in.)	8.5	8.5	8.5	8.5	8.5	9.5	9.5	9.5	9.5	9.5	9.5	9.5	10.5	10.5	10.5	10.5	10.5	10.5	10.5
DIFFERENTIAL Type Bearings, Type	2-Pinion Tapered Roller					2-Pinion Tapered Roller			2-Pinion Tapered Roller				4-Pinion Tapered Roller			4-Pinion Tapered Roller				
	AXLE SHAFTS Type	Semi-Floating Integral Shaft and Drive Flange					Semi-Floating Integral Shaft and Drive Flange			Semi-Floating Integral Shaft and Drive Flange				Full-Floating Integral Shaft and Drive Flange			Full-Floating Integral Shaft and Drive Flange			
Min. Diameter (in.)		—					—			1.42				1.35			1.35			
HOUSING @ SPRING SEAT Section Diameter and Thickness (in.)	3.0 x .25					3.0 x .25			3.34 x .268				3.49 x .215 (C)			3.49 x .265 (K)				

FRONT AXLES										
AXLE MAKE AND CAPACITY (lbs.)	GM 3350-3925					GM 3750-4250				
PINION & RING GEAR Type	Hypoid					Hypoid				
	Ratio	3.42	3.73	4.10			3.42	3.73	4.10	4.56
	Pinion Teeth	12	11	10			12	11	10	9
	Ring Gear Teeth	41	41	41			41	41	41	41
	Ring Gear Dia. (in.)	8.25	8.25	8.25			9.25	9.25	9.25	9.25
DIFFERENTIAL Type Bearings, Type	2-Pinion Tapered Roller					2-Pinion Tapered Roller				
	LUBRICANT CAPACITY (pints)	4.5					6			

FOUR-WHEEL DRIVE MODELS

MODEL	K1500 REG. CAB SPORTSIDE/ FLEETSIDE	K1500 REG. CAB FLEETSIDE	K1500 EXT. CAB FLEETSIDE	K2500 REG. CAB FLEETSIDE	K2500 EXT. CAB FLEETSIDE	K3500 REG. CAB FLEETSIDE	K3500 EXT. CAB FLEETSIDE
MODEL NUMBER	CK10703/E62 CK10703/E63	CK10903/E63	CK10753/E63 CK10953/E63	CK20903/E63	CK20753/E63 CK20953/E63	CK30903/E63	CK30953/E63
		GAS B3J	GAS B3J	GAS B3J	GAS B3J	GAS B3J	GAS B3J

STANDARD SUSPENSION

PAYLOAD (Maximum lbs.) ¹	1459	1489	1336	1440	1750 1615	1572 1431	2848	2339	2719 2511	2817 1668	4684	4739	4347	4468
GVWR (lbs.)	5600		5600	6100	6200	6600	7200		7200		10,000		10,000	
GAWR (lbs.) Front Rear	3350 3400		3400 3400	3600 3750	3600 3750		3750 4670		3750 4410		3750 7500		3750 7500	
FRONT SUSPENSION Type Standard Spring Capacity Total (lbs.)	Independent Torsion Bar		Independent Torsion Bar		Independent Torsion Bar		Independent Torsion Bar		Independent Torsion Bar		Independent Torsion Bar		Independent Torsion Bar	
Front Shock Absorbers Piston Diameter (mm) Std/Opt	25/32 ²		25/32 ²		25/32 ²		32/—		32/—		32/—		32/—	
Front Stabilizer Bar Diameter (in.) Std/Opt	1.18		1.18		1.18		1.18		1.18		1.18		1.18	
REAR SUSPENSION Type	Semi-Elliptic 2-Stage Multi-Leaf Spring		Semi-Elliptic 2-Stage Multi-Leaf Spring		Semi-Elliptic 2-Stage Multi-Leaf Spring		Semi-Elliptic 2-Stage Multi-Leaf Spring		Semi-Elliptic 2-Stage Multi-Leaf Spring		Comb. Semi-Elliptic 2-Stage Main/Aux		Comb. Semi-Elliptic 2-Stage Main/Aux	
Standard Spring Cap. Total (lbs.) Leaves Per Spring Leaf Thickness (in.)	3750 4 2.14		3750 4 2.14		3750 4 2.14		4800 5 2.71		4800 5 2.71		7500 6/1 4.86		7500 6/1 4.86	
Rear Shock Absorber Piston Diameter (mm) Std/Opt	25/32 ²		25/32 ²		25/32 ²		32/—		32/—		32/—		32/—	
FRONT AXLE Type Make Maximum Capacity (lbs.) Standard Hub Locks Pinion/Ring Gear Type	Independent GM 3350 Insta-Trac Hypoid		Independent GM 3450 3925 Insta-Trac Hypoid		Independent GM 3925 Insta-Trac Hypoid		Independent GM 3925 Insta-Trac Hypoid		Independent GM 3925 Insta-Trac Hypoid		Independent GM 4250 Insta-Trac Hypoid		Independent GM 4250 Insta-Trac Hypoid	
REAR AXLE Type Make Maximum Capacity (lbs.) Pinion/Ring Gear Type	Semi- Floating GM 3750 Hypoid		Semi- Floating GM 3750 Hypoid		Semi- Floating GM 3750 4800 Hypoid		Semi- Floating GM 4800 Hypoid		Semi- Floating GM 4800 Hypoid		Full- Floating GM 7500 Hypoid		Full- Floating GM 7500 Hypoid	
STANDARD TIRES Front/Rear Tire Capacity (lbs.) each Front/Rear Inflation (psi) max. Revolutions per mile @ 45 mph	Tubeless SBR LT225/75R16C BW 1940 50 704		Tubeless SBR LT225/75R16C BW 1940 50 704 704		Tubeless SBR LT245/75R16C BW 2205 50 681		Tubeless SBR LT225/75R16D BW 2335 65 706		Tubeless SBR LT245/75R16D BW 2205 50 681		Tubeless SBR LT245/75R16D BW 2335 65 678		Tubeless SBR LT245/75R16D BW 2335 65 678	
WHEELS Size Capacity (lbs.) each Bolt Holes Bolt Circle Diameter (in.) Offset (mm)	16.0 x 6.5 1700 6 5.5 44		16.0 x 6.5 1700 6 5.5 44		16.0 x 6.5 2400 6 5.5 50		16.0 x 6.5 2400 6 5.5 50		16.0 x 6.5 2400 6 5.5 50		16.0 x 6.0 2440 8 6.5 127		16.0 x 6.0 2440 8 6.5 127	

¹Based on Curb Weight. ²46mm shocks on Z71 Off-Road Package.

TWO-WHEEL DRIVE MODELS

MODEL	C1500 REG. CAB SPORTSIDE/ FLEETSIDE	C1500 REG. CAB FLEETSIDE	C1500 EXT. CAB FLEETSIDE	C2500 REG. CAB FLEETSIDE	C2500 EXT. CAB FLEETSIDE	C3500 REG. CAB FLEETSIDE	C3500 EXT. CAB FLEETSIDE
MODEL NUMBER	CC10703/E62 CC10703/E63	CC10903/E63	CC10753/E63 CC10953/E63	CC20903/E63	CC20953/E63	CC30903/E63	CC30953/E63
		GAS B3J	GAS B3J	GAS B3J	GAS B3J	GAS B3J	GAS B3J

OPTIONAL SUSPENSION

OPTION	—	F44	—	—	C6P	C6P	—	—		
PAYLOAD (Maximum lbs.) ¹	—	2250	—	—	4368	3617	4073	3413	—	—
GVWR (lbs.)	—	6100	—	—	8600	8600	—	—	—	—
GAWR (lbs.) Front Rear	— —	3150 3686	— —	— —	3600 6000	3600 6000	— —	— —	— —	— —
FRONT SUSPENSION Type	—	Ind. Coil Spring	—	—	Independent Coil Spring	Independent Coil Spring	—	—	—	—
Spring Capacity Total (lbs.)	—	3150	—	—	3600	3600	—	—	—	—
Front Shock Absorbers Piston Diameter (mm) Std/Opt	—	25/32 ²	—	—	35/—	35/—	—	—	—	—
Front Stabilizer Bar Diameter (in.) Std/Opt	—	1.25	—	—	1.25	1.25	—	—	—	—
REAR SUSPENSION Type	—	Semi-Ell. 2-Stage Multi- Leaf Spring	—	—	Semi-Elliptic 2-Stage Multi-Leaf Spring	Semi-Elliptic 2-Stage Multi-Leaf Spring	—	—	—	—
Standard Spring Cap. Total (lbs.)	—	3750	—	—	6000	6000	—	—	—	—
Leaves Per Spring	—	4	—	—	6	6	—	—	—	—
Leaf Total Thickness (in.)	—	2.14	—	—	3.27	3.27	—	—	—	—
Rear Shock Absorber Piston Diameter (mm) Std/Opt	—	25/32 ²	—	—	32/—	32/—	—	—	—	—
FRONT AXLE Type	—	—	—	—	—	—	—	—	—	—
Make	—	—	—	—	—	—	—	—	—	—
Maximum Capacity (lbs.)	—	3150	—	—	3800	3800	—	—	—	—
Standard Hub Locks	—	—	—	—	—	—	—	—	—	—
Pinion/Ring Gear Type	—	—	—	—	—	—	—	—	—	—
REAR AXLE Type	—	Semi- Floating	—	—	Semi-Floating	Semi-Floating	—	—	—	—
Make	—	GM	—	—	GM	GM	—	—	—	—
Maximum Capacity (lbs.)	—	3750	—	—	6000	6000	—	—	—	—
Pinion/Ring Gear Type	—	Hypoid	—	—	Hypoid	Hypoid	—	—	—	—
STANDARD TIRES Front/Rear	—	Tbis SBR P235/ 75R15 BW 1843	—	—	Tubeless SBR LT245/75R16E BW	Tubeless SBR LT245/75R16E BW	—	—	—	—
Tire Capacity (lbs.) each Front/Rear	—	—	—	—	3042	3042	—	—	—	—
Inflation (psi) max.	—	35	—	—	80	80	—	—	—	—
Revolutions per mile @ 45 mph	—	722	—	—	678	678	—	—	—	—
WHEELS Size	—	15x7	—	—	16x6.5	16x6.5	—	—	—	—
Capacity (lbs.) each	—	1843	—	—	3000	3000	—	—	—	—
Bolt Holes	—	5	—	—	8	8	—	—	—	—
Bolt Circle Diameter (in.)	—	5	—	—	6.5	6.5	—	—	—	—
Offset (mm)	—	13	—	—	17	17	—	—	—	—

¹ Based on Curb Weight. ² 46mm shocks with ZQ8 Sport Handling Package.

K PICKUP

WHEELS AND TIRES

— - Not Available
 AS - All-Season
 SBR - Steel-Belted Radial Ply

BW - Blackwall
 WW - Whitewall
 WL - White Lettered

HWY - Highway
 ON-OFF - On-Off Road
 WOL - White Outline Lettered

TIRE SIZE	TYPE	RPO	PLY	LOAD RANGE	TIRE CAPACITY (lbs. ea.)	INFLATION (psi) max.	WHEEL SIZE (in.)	WHEEL CAPACITY (lbs. ea.)	BOLT HOLES	BOLT CIRCLE dia. (in.)	OFFSET (mm)	REV.PER mile @ 45 mph
P225/75R15 Tubeless	AS/SBR/WL Front	XEV	—	Std	1703	35	15.0 x 6.0	1702	5	5	0	737
	Rear	YEV	—	Std	1703	35	15.0 x 6.0	1702	5	5	0	737
	Spare	ZEV	—	Std	1703	35	15.0 x 6.0	1702	5	5	0	737
P225/75R15 Tubeless	AS/SBR/BW Front	XET	—	Std	1703	35	15.0 x 6.0	1702	5	5	0	737
	Rear	YET	—	Std	1703	35	15.0 x 6.0	1702	5	5	0	737
	Spare	ZET	—	Std	1703	35	15.0 x 6.0	1702	5	5	0	737
P235/75R15 Tubeless	AS/SBR/BW Front	XFL	—	Std	1843	35	15.0 x 6.0	1702	5	5	0	722
	Rear	YFL	—	Std	1843	35	15.0 x 6.0	1702	5	5	0	722
	Spare	ZFL	—	Std	1843	35	15.0 x 6.0	1702	5	5	0	722
P235/75R15 Tubeless	AS/SBR/WW Front											
	Reg. Cab											
	w/5600 GVWR	XFM	—	Std	1843	35	15.0 x 6.0	1702	5	5	0	722
	w/6100 GVWR	XFM	—	Std	1843	35	15.0 x 7.0	1843	5	5	13	722
	C1500 Ext Cab	XFM	—	Std	1843	35	15.0 x 7.0	1843	5	5	13	722
	Rear											
	Reg. Cab											
	w/5600 GVWR	YFM	—	Std	1843	35	15.0 x 6.0	1702	5	5	0	722
	w/6100 GVWR	YFM	—	Std	1843	35	15.0 x 7.0	1843	5	5	13	722
	C1500 Ext Cab	YFM	—	Std	1843	35	15.0 x 7.0	1843	5	5	13	722
	Spare											
	Reg. Cab											
w/5600 GVWR	ZFM	—	Std	1843	35	15.0 x 6.0	1702	5	5	0	722	
w/6100 GVWR	ZFM	—	Std	1843	35	15.0 x 7.0	1843	5	5	13	722	
C1500 Ext Cab	ZFM	—	Std	1843	35	15.0 x 7.0	1843	5	5	13	722	
P235/75R15 Tubeless	AS/SBR/WL Front											
	Reg. Cab											
	w/5600 GVWR	XFN	—	Std	1843	35	15.0 x 6.0	1702	5	5	0	722
	w/6100 GVWR	XFN	—	Std	1843	35	15.0 x 7.0	1843	5	5	13	722
	C1500 Ext Cab	XFN	—	Std	1843	35	15.0 x 7.0	1843	5	5	13	722
	Rear											
	Reg. Cab											
	w/5600 GVWR	YFN	—	Std	1843	35	15.0 x 6.0	1702	5	5	0	722
	w/6100 GVWR	YFN	—	Std	1843	35	15.0 x 7.0	1843	5	5	13	722
	C1500 Ext Cab	YFN	—	Std	1843	35	15.0 x 7.0	1843	5	5	13	722
	Spare											
	Reg. Cab											
w/5600 GVWR	ZFN	—	Std	1843	35	15.0 x 6.0	1702	5	5	0	722	
w/6100 GVWR	ZFN	—	Std	1843	35	15.0 x 7.0	1843	5	5	13	722	
C1500 Ext Cab	ZFN	—	Std	1843	35	15.0 x 7.0	1843	5	5	13	722	
P275/60R15 Tubeless	AS/SBR/BW Front	XCN	—	Std	1953	35	15.0 x 7.0	1843	5	5	0	743
	Rear	YCN	—	Std	1953	35	15.0 x 7.0	1843	5	5	0	743
	Spare	ZCN	—	Std	1953	35	15.0 x 7.0	1843	5	5	0	743
LT225/75R16C Tubeless	AS/SBR/BL Front											
	K1500 Series	XHE	6	C	1940	50	16.0 x 6.5	1700	6	5.5	44	704
	C3500 Series w/R05	XHE	6	C	1940	55	16.0 x 6.0	2400	8	6.5	127	704
	w/o B3J											
	C3500 Series w/R05 w/B3J	XHE	6	C	1940	55	16.0 x 6.0	2400	8	6.5	127	704
Rear	YHE	6	C	1940	50	16.0 x 6.5	1700	6	5.5	127	704	
Spare	ZHE	6	C	1940	50	16.0 x 6.5	1700	6	5.5	44	704	
LT225/75R16C Tubeless	ON-OFF SBR/BW Front											
	Rear	XHJ	6	C	1940	50	16.0 x 6.5	1700	6	5.5	44	704
	Spare	YHJ ZHJ	6	C	1940	50	16.0 x 6.5	1700	6	5.5	44	704

FOUR-WHEEL DRIVE MODELS

MODEL	K1500 REG. CAB SPORTSIDE/ FLEETSIDE	K1500 REG. CAB FLEETSIDE	K1500 EXT. CAB FLEETSIDE	K2500 REG. CAB FLEETSIDE	K2500 EXT. CAB FLEETSIDE	K3500 REG. CAB FLEETSIDE	K3500 EXT. CAB FLEETSIDE
MODEL NUMBER	CK10703/E62 CK10703/E63	CK10903/E63	CK10753/E63 CK10953/E63	CK20903/E63	CK20953/E63	CK30903/E63	CK30953/E63
		GAS B3J	GAS B3J	GAS B3J	GAS B3J	GAS B3J	GAS B3J

OPTIONAL SUSPENSION

OPTION	F44	F44	—	F44	—	C6P	C6P	—	—
PAYLOAD (Maximum lbs.) ¹	1935 1968	1819	—	1750 1615	—	4000 3739	3628 3739	—	—
GVWR (lbs.)	6100	6100	—	6600	—	8600	8600	—	—
GAWR (lbs.) Front Rear	3600 3750	3600 3750	—	3600 3750	—	3750 6000	3750 6000	—	—
FRONT SUSPENSION Type	Independent Torsion Bar	Ind. Torsion Bar	—	Ind. Torsion Bar	—	Independent Torsion Bar	Independent Torsion Bar	—	—
Standard Spring Capacity Total (lbs.)	3600	3600	—	3600	—	3750	3750	—	—
Front Shock Absorbers Piston Diameter (mm) Std/Opt	25/32 ²	25/32 ²	—	25/32 ²	—	35/—	35/—	—	—
Front Stabilizer Bar Diameter (in.) Std/Opt	1.18	1.18	—	1.18	—	1.18	1.18	—	—
REAR SUSPENSION Type	Semi-Elliptic 2-Stage Multi-Leaf Spring	Semi-Ell. 2-Stage Multi- Leaf Spring	—	Semi-Ell. 2-Stage Multi- Leaf Spring	—	Semi-Elliptic 2-Stage Multi-Leaf Spring	Semi-Elliptic 2-Stage Multi-Leaf Spring	—	—
Standard Spring Cap. Total (lbs.)	3750	3750	—	3750	—	6000	6000	—	—
Leaves Per Spring	4	4	—	4	—	6	6	—	—
Leaf Total Thickness (in.)	2.14	2.14	—	2.14	—	3.27	3.27	—	—
Rear Shock Absorber Piston Diameter (mm) Std/Opt	25/32 ²	25/32 ²	—	25/32 ²	—	32/—	32/—	—	—
FRONT AXLE Type	Independent	Indpt.	—	Indpt.	—	Independent	Independent	—	—
Make	GM	GM	—	GM	—	GM	GM	—	—
Maximum Capacity (lbs.)	3925	3925	—	4800	—	4250	4250	—	—
Standard Hub Locks	Insta-Trac	Insta- Trac	—	Insta- Trac	—	Insta-Trac	Insta-Trac	—	—
Pinion/Ring Gear Type	Hypoid	Hypoid	—	Hypoid	—	Hypoid	Hypoid	—	—
REAR AXLE Type	Semi-Floating	Semi- Floating	—	Semi- Floating	—	Semi-Floating ³	Semi-Floating ³	—	—
Make	GM	GM	—	GM	—	GM	GM	—	—
Maximum Capacity (lbs.)	3750	3750	—	3925	—	6000	6000	—	—
Pinion/Ring Gear Type	Hypoid	Hypoid	—	Hypoid	—	Hypoid	Hypoid	—	—
STANDARD TIRES Front/Rear	Tubeless SBR LT225/75R16C BW	TbIs. SBR LT225/ 75R16C BW	—	TbIs. SBR LT245/ 75R16C BW	—	Tubeless SBR LT245/75R16E BW	Tubeless SBR LT245/75R16E BW	—	—
Tire Capacity (lbs.) each Front/Rear	1940	1940	—	2205	—	3042	3042	—	—
Inflation (psi) max.	50	50	—	45	—	80	80	—	—
Revolutions per mile @ 45 mph	704	704	—	681	—	678	678	—	—
WHEELS Size	16.0 x 6.5	16.0 x 6.5	—	16.0 x 6.5	—	16.0 x 6.5	16.0 x 6.5	—	—
Capacity (lbs.) each	2400	2400	—	2400	—	3000	3000	—	—
Bolt Holes	6	6	—	6	—	8	8	—	—
Bolt Circle Diameter (in.)	5.5	5.5	—	5.5	—	6.5	6.5	—	—
Offset (mm)	50	50	—	50	—	17	17	—	—

¹ Based on Curb Weight ² 46mm shocks on Z71 Off-Road Package. ³ Full-Floating rear axle w/7.4L engine.

K PICKUP

WHEELS AND TIRES

— Not Available
AS - All-Season
SBR - Steel-Belted Radial Ply

BW - Blackwall
WW - Whitewall
WL - White Lettered

HWY - Highway
ON-OFF - On-Off Road
WOL - White Outline Lettered

TIRE SIZE	TYPE	RPO	PLY	LOAD RANGE	TIRE CAPACITY (lbs.) ea.	INFLATION (psi) max.	WHEEL SIZE (in.)	WHEEL CAPACITY (lbs.) ea.	BOLT HOLES	BOLT CIRCLE dia. (in.)	OFFSET (mm)	REV.PER mile @ 45 mph
LT245/75R16E Tubeless	ON-OFF SBR/BW Front K2500 Reg. Cab w/o C6P K2500/3500 w/C6P	XGK	10	E	3042	80	16.0 x 6.5	2400	6	5.5	50	678
		XGK	10	E	3042	80	16.0 x 6.5	3000	8	6.5	17	678
	Rear K2500 Reg. Cab w/o C6P K2500/3500 w/C6P	YGK	10	E	3042	80	16.0 x 6.5	2400	6	5.5	50	678
		YGK	10	E	3042	80	16.0 x 6.5	3000	8	6.5	17	678
	Spare C/K2500 C/K3500	ZGK	10	E	3042	80	16.0 x 6.5	2400	6	5.5	50	678
		ZGK	10	E	3042	80	16.0 x 6.5	3000	8	6.5	17	678
LT265/75R16C Tubeless	ON-OFF SBR/BW Front Reg. Cab Ext. Cab	XGL	6	C	2470	50	16.0 x 6.5	1700	6	5.5	44	655
		XGL	6	C	2470	50	16.0 x 6.5	2400	6	5.5	50	655
	Rear Reg. Cab Ext. Cab	YGL	6	C	2470	50	16.0 x 6.5	1700	6	5.5	44	655
		YGL	6	C	2470	50	16.0 x 6.5	2400	6	5.5	50	655
	Spare Reg. Cab Ext. Cab	ZGL	6	C	2470	50	16.0 x 6.5	1700	6	5.5	44	655
		ZGL	6	C	2470	50	16.0 x 6.5	2400	6	5.5	50	655
LT265/75R16C Tubeless	ON-OFF SBR/WOL Front Reg. Cab Ext. Cab	XGM	6	C	2470	50	16.0 x 6.5	1700	6	5.5	44	655
		XGM	6	C	2470	50	16.0 x 6.5	2400	6	5.5	50	655
	Rear Reg. Cab Ext. Cab	YGM	6	C	2470	50	16.0 x 6.5	1700	6	5.5	44	655
		YGM	6	C	2470	50	16.0 x 6.5	2400	6	5.5	50	655
	Spare Reg. Cab Ext. Cab	ZGM	6	C	2470	50	16.0 x 6.5	1700	6	5.5	44	655
		ZGM	6	C	2470	50	16.0 x 6.5	2400	6	5.5	50	655
7.50-16D Tubeless	HWY Nylon BW Front w/o B3J w/B3J	XDE	8	D	2140	60	16.0 x 6.0	2440	8	6.5	127	652
		XDE										
	Rear w/o B3J w/B3J	YDE	8	D	2140	60	16.0 x 6.0	2440	8	6.5	127	652
Spare	ZDE	8	D	2140	60	16.0 x 6.0	2440	8	6.5	127	652	
7.50-16D Tubeless	ON-OFF Nylon BW Front w/o B3J w/B3J	XDL	8	D	2140	60	16.0 x 6.0	2440	8	6.5	127	652
		XDL										
	Rear w/o B3J w/B3J	YDL	8	D	2140	60	16.0 x 6.0	2440	8	6.5	127	652
Spare	ZDL	8	D	2140	60	16.0 x 6.0	2440	8	6.5	127	652	

WHEELS AND TIRES

KEY: --- Not Available
 AS - All-Season
 SBR - Steel-Belted Radial Ply
 BW - Blackwall
 WW - Whitewall
 WL - White Lettered
 HWY - Highway
 ON-OFF - On-Off Road
 WOL - White Outline Lettered

TIRE SIZE	TYPE	RPO	PLY	LOAD RANGE	TIRE CAPACITY (lbs. ea.)	INFLATION (psi) max.	WHEEL SIZE (in.)	WHEEL CAPACITY (lbs. ea.)	BOLT HOLES	BOLT CIRCLE dia. (in.)	OFFSET (mm)	REV.PER mile @ 45 mph
LT225/75R16C Tubeless	ON-OFF SBR/WOL Front Rear Spare	XHN YHN ZHN	6	C	1940	50	16.0 x 6.5	1700	6	5.5	44	704
LT225/75R16D Tubeless	AS/SBR/BW Front	XHP	8	D	2335	65	16.0 x 6.5	2400	6	5.5	50	706
	C3500 w/R05 w/o B3J	XHP	8	D	2150	55	16.0 x 6.0	2440	8	6.5	127	706
	C3500 w/R05 w/ B3J	XHP	8	D	2150	55	16.0 x 6.0	2440	8	6.5	127	706
	Rear C3500 w/R05 w/o B3J	YHP	8	D	2335	65	16.0 x 6.5	2400	6	5.5	50	706
	C3500 w/R05 w/ B3J	YHP	8	D	2150	55	16.0 x 6.0	2440	8	6.5	127	706
	C3500 w/R05 w/ B3J	YHP	8	D	2150	55	16.0 x 6.0	2440	8	6.5	127	706
	Spare C3500 w/R05	ZHP ZHP	8 8	D D	2335 2150	65 55	16.0 x 6.5 16.0 x 6.0	2400 2440	6 8	5.5 6.5	50 127	706 706
LT225/75R16D Tubeless	ON-OFF AS/SBR/BW Front											
	K2500 Reg. Cab	XHR	8	D	2335	65	16.0 x 6.5	2400	6	5.5	50	706
	K3500 w/o B3J	XHR	8	D	2335	65	16.0 x 6.5	3000	8	6.5	17	706
	K3500 w/B3J	XHR	8	D	2335	65	16.0 x 6.0	2440	8	6.5	127	706
	Rear C/K2500 Reg. Cab	YHR	8	D	2335	65	16.0 x 6.5	2400	6	5.5	50	706
	C/K3500 w/R05 w/o B3J	YHR	8	D	2335	65	16.0 x 6.0	2440	8	6.5	127	706
	C/K3500 w/R05 w/B3J	YHR	8	D	2335	65	16.0 x 6.0	2440	8	6.5	127	706
Spare K3500, C2500 Reg. Cab	ZHR	8	D	2335	65	16.0 x 6.5	2400	6	5.5	50	706	
	CK3500 w/o R05	ZHR	8	D	2335	65	16.0 x 6.0	2440	8	6.5	127	706
LT245/75R16C Tubeless	AS/SBR/BW Front Rear Spare K1500 K2500	XBK YBK ZBK ZBK	6	C	2205	50	16.0 x 6.5	2400	6	5.5	50	681
LT245/75R16C Tubeless	ON-OFF SBR/BW Front Rear Spare K1500 K2500	XBN YBN ZBN ZBN	6	C	2205	50	16.0 x 6.5	2400	6	5.5	50	681
LT245/75R16C Tubeless	ON-OFF SBR/WL Front Rear Spare K1500 K2500	XBX YBX ZBX ZBX	6	C	2205	50	16.0 x 6.5	2400	6	5.5	50	681
LT245/75R16E	AS/SBR/BW Front Rear Spare	XHH YHH ZHH	10	E	3042	80	16.0 x 6.5	3000	8	6.5	17	678

TWO-WHEEL DRIVE MODELS

MODEL	C1500 REG. CAB SPORTSIDE/ FLEETSIDE	C1500 REG. CAB FLEETSIDE	C1500 EXT. CAB FLEETSIDE	C2500 REG. CAB FLEETSIDE	C2500 EXT. CAB FLEETSIDE			C3500 REG. CAB FLEETSIDE	C3500 EXT. CAB FLEETSIDE
MODEL NUMBER	CC10703/E62 CC10703/E63	CC10903/E63	CC10753/E63 CC10953/E63	CC20903/E63	CC20753/ E63	CC20953/ E63	CC20953/ E63 C6P	CC30903/E63	CC30953/E63

FRAME

Side Rail Dimensions Width (in.)	2.28	2.28	2.28	2.28		2.28			2.28	2.28	
Depth (in.)	6.30	6.30	6.30	6.30	7.24	6.30	6.30	7.24	7.24	7.24	
Thickness (in.)	.130	.130	.165	.130	.213	.165	.165	.244	.213	.244	
Section Modulus Rails only (cu. in.)	2.66	2.66	3.37	2.26	5.26	3.37	3.37	6.06	5.26	6.06	
RBM of Frame (lb. in.)	95,760	95,760	121,320	95,760	189,360	121,320	121,320	218,160	189,360	218,160	
Width Over Rails Front (in.)	45.3	45.3	45.3	45.3		45.3			45.3	45.3	
Rear (in.)	36.7	36.7	36.7	36.7		36.7			36.7	36.7	
Overall Length of Rail (in.)	181.1	200.0	205.1	224.0	200.0	200.1	205.1	224.0	224.1	200.1	224.1

STEERING

Type	Variable Ratio Integral Power	Variable Ratio Integral Power	Variable Ratio Integral Power	Variable Ratio Integral Power	Variable Ratio Integral Power			Variable Ratio Integral Power	Variable Ratio Integral Power		
Steering Ratio On Center/At Lock	16/13:1 ¹	16/13:1 ¹	16/13:1 ¹	16/13:1	16/13:1	16/13:1	16/13:1	16/13:1	16/13:1	16/13:1	
Turning Diameter Curb-To-Curb (ft.) Wall-To-Wall (ft.)	41.3 43.2	44.6 46.5	48.1 50.0	52.9 54.8	44.6 46.5	45.7 47.5	48.1 50.1	52.9 54.8	52.9 54.8	45.7 47.5	52.9 54.8

BRAKES

GVWR (lbs.)	5600	5600	6100	6200	7200	8600	7200	8600	10,000	10,000
Type	Vac. Power	Vac. Power		Vac. Power	Vac. Power		Vac. Power		Hyd. Power	Hyd. Power
	Front Disc/Rear Drum w/Rear Wheel Anti-Lock Brake System	Front Disc/Rear Drum w/Rear Wheel Anti-Lock Brake System	Front Disc/Rear Drum w/Rear Wheel Anti-Lock Brake System	Front Disc/Rear Drum w/Rear Wheel Anti-Lock Brake System	Front Disc/Rear Drum w/Rear Wheel Anti-Lock Brake System	Front Disc/Rear Drum w/Rear Wheel Anti-Lock Brake System	Front Disc/Rear Drum w/Rear Wheel Anti-Lock Brake System	Front Disc/Rear Drum w/Rear Wheel Anti-Lock Brake System	Front Disc/Rear Drum w/Rear Wheel Anti-Lock Brake System	Front Disc/Rear Drum w/Rear Wheel Anti-Lock Brake System
Booster Diaphragm Diameter (in.)	9.5 Tandem	9.5 Tandem		9.5 Tandem	9.5 Tandem		9.5 Tandem		—	—
Front Rotor Size Diameter x Thickness (in.)	11.57 x 1.0	11.57 x 1.0	11.57 x 1.25	11.57 x 1.25	11.57 x 1.25	12.50 x 1.26	11.57 x 1.25	12.50 x 1.26	12.50 x 1.26	12.50 x 1.26
Front Facing Contact Per Axle (sq. in.)	34.8	34.8		34.8	34.8	38.0	34.8	38.0	38.0	38.0
Rear Drum Size Diameter x Width (in.)	10.0 x 2.25	10.0 x 2.25		10.0 x 2.25	11.15 x 2.75	13.0 x 2.5	11.15 x 2.75	13.0 x 2.5	13.0 x 3.5	13.0 x 3.5
Rear Facing Contact Per Axle (sq. in.)	84.88	84.88		84.88	115.84	116.73	115.84	116.73	166.04	166.04
Parking Brake Type	Cable To Rear Wheels	Cable To Rear Wheels		Cable To Rear Wheels	Cable To Rear Wheels		Cable To Rear Wheels		Cable To Rear Wheels	Cable To Rear Wheels

¹ZQ8 Sport Suspension has a 12.7:1 ratio.

OPTIONAL WHEELS

RPO	DESCRIPTION	WHEEL SIZE (in.)	CAPACITY (lbs.)	BOLT HOLES	BOLT CIRCLE dia. (in.)	OFFSET (mm)
—	Wheels—Chrome (Part of BYP 2-Wheel Drive Sport Equip. Pkg.)	15.0 x 7.0	1843	5	5.0	13
—	Wheels—Chrome (Part of B4U and ZQ8 w/BYP)	15.0 x 7.0	1843	5	5.0	0
—	Wheels—Styled Painted (Part of ZQ8)	15.0 x 7.0	1843	5	5.0	0
N90	Wheels—Aluminum, Cast (2-Wheel Drive)	15.0 x 7.0	1843	5	5.0	13
PF4	Wheels—Aluminum, Cast (4-Wheel Drive)	16.0 x 7.0	1702	6	5.5	44

TWO WHEEL DRIVE AND FOUR WHEEL DRIVE MODELS

MODEL	C/K1500 REG. CAB SPORTSIDE/ FLEETSIDE	C/K1500 REG. CAB FLEETSIDE	C/K1500 EXTENDED CAB FLEETSIDE	C/K2500 REGULAR/EXTENDED CAB FLEETSIDE	C/K3500 REGULAR CAB FLEETSIDE	C/K3500 EXTENDED CAB FLEETSIDE
MODEL NUMBER	C/K10703/E62 C/K10703/E63	C/K10903/E63	C/K10753/E63 C/K10953/E63	C/K20903/E63-C/K20753/E63 C/K20953/E63	C/K30903/E63	C/K30953/E63

ELECTRICAL

ENGINE Std/Opt	4.3L V6/ 5.7L V8	5.0L V8	4.3L V6/ 5.7L V8	5.0L V8	6.2L V8	4.3L V6/ 5.7L V8	5.0L V8	6.2L V8	4.3L V6/ 5.7L V8	5.0L V8	6.2L V8	7.4L V8	7.4L V8	5.7L V8	6.2L V8	7.4L V8	5.7L V8	6.2L V8
STANDARD BATTERY Cold Cranking Amps @ 0° F @ -20° F Reserve Capacity Minutes @ 80° F	630 470	630 470	630 470	630 470	Two at 570 425	630 470	630 470	Two at 570 425	630 470	630 470	Two at 570 425	630 470	630 470	630 470	Two at 570 425	630 470	630 470	Two at 570 425
AUXILIARY BATTERY Cold Cranking Amps @ 0° F @ -20° F Reserve Capacity Minutes @ 80° F	TP2 540 405	TP2 540 405	TP2 540 405	TP2 540 405	— —	TP2 540 405	TP2 540 405	— —	TP2 540 405	TP2 540 405	— —	TP2 540 405	TP2 540 405	TP2 540 405	— —	TP2 540 405	TP2 540 405	— —
STANDARD ALTERNATOR Max. Capacity (Amps) Max. Watts @ 12 Volts Nominal Amp @ Idle approximately Drive Pulley Ratio Model Number	85 1020 30 3.2:1 CS130	85 1020 30 3.2:1 CS130	85 1020 30 3.2:1 CS130	85 1020 30 3.2:1 CS130	85 1020 30 3.0:1 CS130	85 1020 30 3.2:1 CS130	85 1020 30 3.2:1 CS130	85 1020 30 3.0:1 CS130	85 1020 30 3.2:1 CS130	85 1020 30 3.2:1 CS130	85 1020 30 3.0:1 CS130	85 1020 30 3.2:1 CS130	85 1020 30 3.2:1 CS130	85 1020 30 3.2:1 CS130	85 1020 30 3.0:1 CS130	85 1020 30 3.2:1 CS130	85 1020 30 3.2:1 CS130	85 1020 30 3.0:1 CS130
OPTIONAL ALTERNATOR¹ Max. Capacity (Amps) Max. Watts @ 12 Volts Nominal Amp @ Idle approximately Drive Pulley Ratio Model Number	C60 100 1200 36 3.2:1 CS130	C60 100 1200 36 3.2:1 CS130	C60 100 1200 36 3.2:1 CS130	C60 100 1200 36 3.2:1 CS130	C60 100 1200 36 3.0:1 CS130	C60 100 1200 36 3.2:1 CS130	C60 100 1200 36 3.2:1 CS130	C60 100 1200 36 3.0:1 CS130	C60 100 1200 36 3.2:1 CS130	C60 100 1200 36 3.2:1 CS130	C60 100 1200 36 3.0:1 CS130	C60 100 1200 36 3.2:1 CS130	C60 100 1200 36 3.2:1 CS130	C60 100 1200 36 3.2:1 CS130	C60 100 1200 36 3.0:1 CS130	C60 100 1200 36 3.2:1 CS130	C60 100 1200 36 3.2:1 CS130	C60 100 1200 36 3.0:1 CS130

¹NOTE: This alternator is available only as part of noted RPO.

ALTERNATOR CURVES

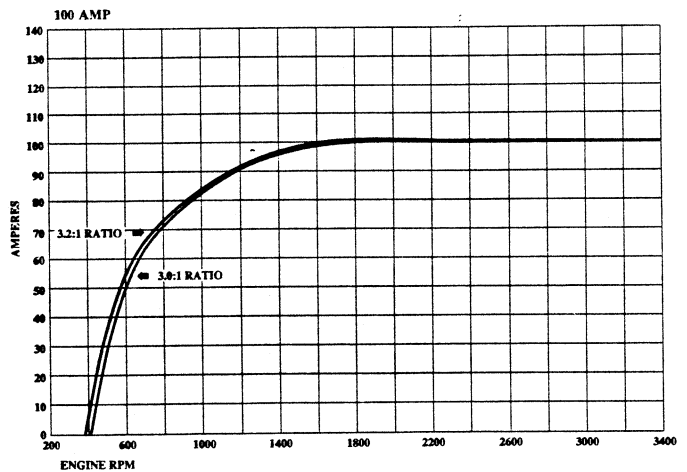
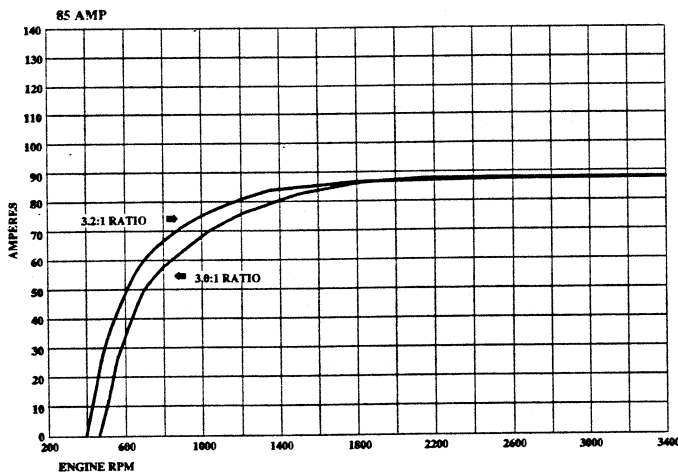

FOUR-WHEEL DRIVE MODELS

MODEL	K1500 REG. CAB SPORTSIDE/ FLEETSIDE	K1500 REG. CAB FLEETSIDE	K1500 EXT. CAB FLEETSIDE	K2500 REG. CAB FLEETSIDE	K2500 EXT. CAB FLEETSIDE			K3500 REG. CAB FLEETSIDE	K3500 EXT. CAB FLEETSIDE
MODEL NUMBER	CK10703/E62 CK10703/E63	CK10903/E63	CK10753/E63 CK10953/E63	CK20903/E63	CK20753/ E63	CK20953/ E63	CK20953/ E63 C6P	CK30903/E63	CK30953/E63
				C6P					

FRAME

Side Rail Dimensions Width (in.)	2.28	2.28	2.28	2.28	2.28			2.28	2.28
Depth (in.)	7.48	7.48	7.48	7.48	7.48			7.48	7.48
Thickness (in.)	.134	.134	.165	.134	.213	.165	.165	.244	.244
Section Modulus Rails only (cu. in.)	3.27	3.27	4.06	3.27	5.25	4.06	4.06	6.06	6.06
RBM of Frame (lb. in.)	117,720	117,720	146,160	117,720	189,000	146,160	146,160	218,160	218,160
Width Over Rails Front (in.)	45.3	45.3	45.3	45.3	45.3			45.3	45.3
Rear (in.)	36.7	36.7	36.7	36.7	36.7			36.7	36.7
Overall Length of Rail (in.)	180.8	199.7	204.8	223.7	199.7	201.0	204.8	223.7	225.1

STEERING

Type	Variable Ratio Integral Power	Variable Ratio Integral Power	Variable Ratio Integral Power	Variable Ratio Integral Power	Variable Ratio Integral Power			Variable Ratio Integral Power	Variable Ratio Integral Power
Steering Ratio On Center/At Lock	16/13:1	16/13:1	16/13:1	16/13:1	16/13:1	16/13:1	16/13:1	16/13:1	16/13:1
Turning Diameter Curb-To-Curb (ft.)	40.3	44.4	47.9	52.2	44.4	45.1	47.9	52.2	52.2
Wall-To-Wall (ft.)	42.3	46.3	49.8	53.7	46.3	46.7	49.8	53.7	53.7

BRAKES

GVWR (lbs.)	5600	6100	5600	6100	6200	6600	7200	8600	7200	8600	10,000	10,000
Type	Vac. Power		Vac. Power		Vac. Power		Vac. Power		Vac. Power		Hyd. Power	Hyd. Power
	Front Disc/Rear Drum w/Rear Wheel Anti-Lock Brake System		Front Disc/Rear Drum w/Rear Wheel Anti-Lock Brake System		Front Disc/Rear Drum w/Rear Wheel Anti-Lock Brake System		Front Disc/Rear Drum w/Rear Wheel Anti-Lock Brake System		Front Disc/Rear Drum w/Rear Wheel Anti-Lock Brake System		Front Disc/Rear Drum w/Rear Wheel Anti-Lock Brake System	Front Disc/Rear Drum w/Rear Wheel Anti-Lock Brake System
Booster Diaphragm Diameter (in.)	9.5 Tandem		9.5 Tandem		9.5 Tandem		9.5 Tandem		9.5 Tandem		—	—
Front Rotor Size Diameter x Thickness (in.)	11.57 x 1.0	11.57 x 1.25	11.57 x 1.0	11.57 x 1.25	11.57 x 1.25		11.57 x 1.20	12.50 x 1.26	11.57 x 1.25	12.50 x 1.26	12.50 x 1.26	
Front Facing Contact Per Axle (sq. in.)	42.24		42.24		42.24		42.24	42.24	42.24	42.24	42.24	42.24
Rear Drum Size Diameter x Width (in.)	10.0 x 2.25		10.0 x 2.25		10.0 x 2.25	11.15 x 2.75	11.15 x 2.75	13.0 x 2.5	11.15 x 2.75	13.0 x 2.5	13.0 x 3.5	13.0 x 3.5
Rear Facing Contact Per Axle (sq. in.)	84.88		84.88		115.84		115.84	116.73	115.84	116.73	166.04	166.04
Parking Brake Type	Cable To Rear Wheels		Cable To Rear Wheels		Cable To Rear Wheels		Cable To Rear Wheels		Cable To Rear Wheels		Cable To Rear Wheels	Cable To Rear Wheels

C/K REGULAR CAB MODELS

MODEL	C/K 1500 PICKUP SPORTSIDE	C/K 1500 PICKUP FLEETSIDE	C/K 2500 PICKUP FLEETSIDE	C/K 3500 PICKUP FLEETSIDE
MODEL NUMBER	CC10703/E62 CC10703/E63 CK10703/E62 CK10703/E63	CC10903/E63 CK10903/E63	CC20903/E63 CK20903/E63 C6P	CC30903 CK30903

EXTERIOR

BODY					
Wheelbase (in.)	WB	117.5	131.5	131.5	131.5
Overall Length (in.) w/o Rear Bumper	OAL	194.0 194.1	212.6	212.6	212.6
Overall Height (in.) Nominal	OAH	2WD 70.4 4WD 73.8	2WD 70.4 4WD 73.8	2WD 73.0 4WD 74.3	2WD 75.5 4WD 75.8
Maximum Width (in.)	OAW	77.1 76.8	76.8	76.8	94.2
Bumper to Axle Front (in.)	BA	34.9	34.9	34.9	34.9
Rear (in.)		47.25	47.27	52.2	52.2
Cab Axle (in.)	CA	41.8	55.9	55.9	55.9
Cab to End of Frame (in.)	—	78.7	97.6	97.6	97.6
Bumper to Back of Cab (in.)	BBC	110.6	110.6	110.6	110.6
Ground To Top of Rear Load Floor (in.)	GF	2WD 29.0 4WD 32.4	2WD 29.0 4WD 32.4	2WD 31.6 4WD 32.9	2WD 34.2 4WD 34.4
Ground Clearance (in.) Front/Rear	—	2WD 7.0/8.4 4WD 8.6/9.0	2WD 7.0/8.4 4WD 8.6/9.0	2WD 7.8/7.8 4WD 8.7/7.7	2WD 8.4/8.1 4WD 7.8/8.1
CARGO BOX					
Inside Length At Floor (in.)	IBL	78.7	97.6	97.6	97.6
Inside Length At Top (in.) Rear	IWR	49.1 61.9	61.9	61.9	61.9
Inside Width At Floor (in.)	IWF	49.1 64.7	64.7	64.7	64.7
Inside Width At Wheelhousing (in.)	IWW	49.1	49.1	49.1	49.1
Inside Height (in.)	—	19.3	19.3	19.3	19.3
Tailgate Width (in.) Top	—	50.9 62.0	62.0	62.0	62.0
SIGN PANEL AREA (in.)	Shaded Area	17 x 48 ³ / ₄	17 x 48 ³ / ₄	17 x 48 ³ / ₄	17 x 48 ³ / ₄

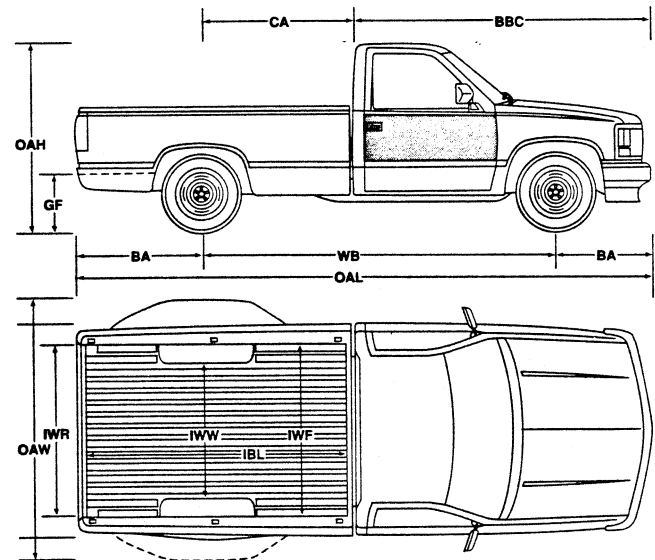
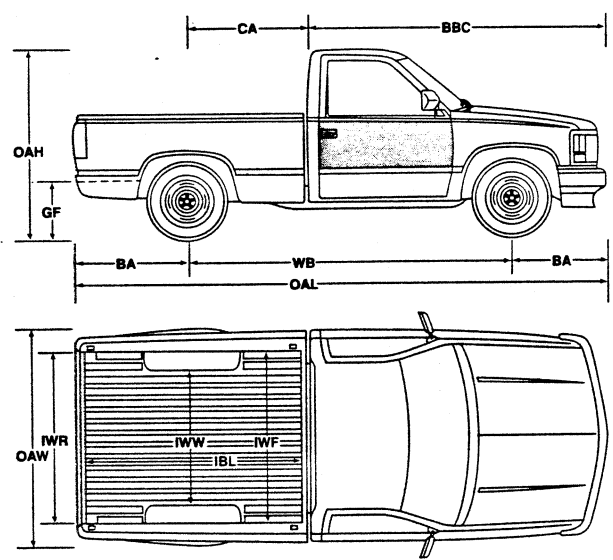

KEY: Reg Type Manual and Automatic Transmission **Bold Type** Automatic Transmission Only

TWO-WHEEL DRIVE AND FOUR-WHEEL DRIVE MODELS

MODEL	C/K1500 REG. CAB SPORTSIDE/ FLEETSIDE	C/K1500-CK2500 REG. CAB-EXT. CAB FLEETSIDE	C/K3500 REG. CAB-EXT. CAB FLEETSIDE
MODEL NUMBER	C/K10703/E62 C/K10703/E63	C/K10753-C/K10903-C/K10953/E63 C/K20753-C/K20903-C/K20953/E63	C/K30903 C/K30953/E63

STANDARD COOLING SYSTEM

ENGINE	4.3L	5.0L	5.7L	4.3L	5.0L	5.7L	6.2L ¹	7.4L	5.7L	7.4L	6.2L
Radiator Thickness (in.)	.93	.93	1.34	.93	.93	1.34	1.58	2.17	1.34	2.17	1.58
System Cap. (gal.)	3.6	3.8	3.9	3.6	3.8	3.9	6.2	6.3	3.9	6.3	6.2
Fan - No. Blades x Diameter x Pitch (in.)	3 x 19 x 2.0			3 x 19 x 2.0	3 x 19 x 2.0	3 x 19 x 2.0	5 x 20 x 2.56	5 x 20 x 2.56	3 x 19 x 2.0	5 x 20 x 2.56	5 x 20 x 2.56

OPTIONAL COOLING SYSTEMS

ENGINE	4.3L	5.0L	5.7L	4.3L	5.0L	5.7L	6.2L ¹	7.4L	5.7L	7.4L	6.2L
AUTOMATIC TRANS.	MX0			MX0				MX0			
Radiator Thickness (in.)	.93	1.34	1.34	.93	1.34	1.34	1.58	2.17	1.34	2.17	1.58
System Capacity (gal.)	3.6	3.8	3.8	3.6	3.8	3.8	6.2	6.3	3.8	6.3	6.2
Fan - No. Blades x Diameter x Pitch (in.)	3 x 19 x 2.0			3 x 19 x 2.0	3 x 19 x 2.0	3 x 19 x 2.0	5 x 20 x 2.56	5 x 20 x 2.56	5 x 19.5 x 2.0	5 x 20 x 2.56	5 x 20 x 2.56
OPT. H.D. RADIATOR	V01 ²			V01 ²				V01 ²			
Radiator Thickness (in.)	1.34	.93	1.34	1.34	.93	1.34	2.17	2.17	1.34	2.17	—
System Capacity (gal.)	3.6	4.2	3.9	3.6	4.2	3.9	6.2	6.3	3.8	6.3	—
Fan - No. Blades x Diameter x Pitch (in.)	5 x 19.5 x 2.0			5 x 19.5 x 2.0	5 x 19.5 x 2.0	5 x 19.5 x 2.0	5 x 20 x 2.56	5 x 20 x 2.56	5 x 19.5 x 2.0	5 x 20 x 2.56	—
OPT. AIR CONDITIONING	C60			C60				C60			
Radiator Thickness (in.)	1.34	.93	1.34	1.34	.93	1.34	1.58	2.17	1.34	2.17	2.17
System Capacity (gal.)	3.6	3.8	3.9	3.6	3.8	3.9	6.2	6.3	3.9	6.3	6.2
Fan - No. Blades x Diameter x Pitch (in.)	5 x 19.5 x 2.0			5 x 19.5 x 2.0	5 x 19.5 x 2.0	5 x 19.5 x 2.0	5 x 20 x 2.56	5 x 20 x 2.56	5 x 19.5 x 2.0	5 x 20 x 2.56	5 x 20 x 2.56
OPT. ENG. OIL COOLER	KC4			KC4	KC4	KC4	—	KC4	—	KC4	—
Radiator Thickness (in.)	1.34			1.34	1.34	1.34	—	2.17	—	2.17	—
System Capacity (gal.)	3.6	3.9	3.9	3.6	3.9	3.9	—	6.2	—	6.2	—
Fan - No. Blades x Diameter x Pitch (in.)	5 x 19.5 x 2.0			5 x 19.5 x 2.0	5 x 19.5 x 2.0	5 x 19.5 x 2.0	—	5 x 20 x 2.56	—	5 x 20 x 2.56	—
OPT. TRANS OIL COOLER AND ENG. OIL COOLER	KC4/ V02			KC4/ V02	KC4/ V02	KC4/ V02	—	KC4/ V02	—	KC4/ V02	—
Radiator Thickness (in.)	1.34			1.34	1.34	1.34	—	2.17	—	2.17	—
System Capacity (gal.)	3.6	3.9	3.9	3.6	3.9	3.9	—	6.2	—	6.2	—
Fan - No. Blades x Diameter x Pitch (in.)	5 x 19.5 x 2.0			5 x 19.5 x 2.0	5 x 19.5 x 2.0	5 x 19.5 x 2.0	—	5 x 20 x 2.56	—	5 x 20 x 2.56	—
OPT. H.D. RADIATOR AND ENGINE OIL COOLER	V02 ³			V02 ³				—			
Radiator Thickness (in.)	1.34	1.34	1.34	1.34	1.34	1.34	2.17	2.17	—	2.17	—
System Capacity (gal.)	3.9	3.9	3.9	3.9	3.9	3.9	6.2	6.2	—	6.2	—
Fan - No. Blades x Diameter x Pitch (in.)	5 x 19.5 x 2.0	5 x 19.5 x 2.0	5 x 19.5 x 2.0	5 x 19.5 x 2.0	5 x 19.5 x 2.0	5 x 19.5 x 2.0	5 x 20 x 2.56	5 x 20 x 2.56	—	5 x 20 x 2.56	—
OPT. AIR CONDITIONING AND TRANS. OIL COOLER								C60/ K34			
Radiator Thickness (in.)	—	—	—	—	—	—	2.17	—	—	—	—
System Capacity (gal.)	—	—	—	—	—	—	6.2	—	—	—	—
Fan - No. Blades x Diameter x Pitch (in.)	—	—	—	—	—	—	5 x 20 x 2.56	—	—	—	—

¹6.2 Diesel N/A in California on C/K1500 Series Model.

² N/A C60 Air or V02 Cooling.

³ Included w/Z82 Trailing.

C/K REGULAR CAB MODELS

MODEL	C/K 1500 PICKUP SPORTSIDE	C/K 1500 PICKUP FLEETSIDE	C/K 2500 PICKUP FLEETSIDE	C/K 3500 PICKUP FLEETSIDE
MODEL NUMBER	CC10703/E62, CK10703/E62 CC10703/E63, CK10703/E63	CC10903/E63, CK10903/E63	CC20903/E63, CK20903/E63	CC30903/E63, CK30903/E63

INTERIOR

CAB		C/K 1500 PICKUP SPORTSIDE	C/K 1500 PICKUP FLEETSIDE	C/K 2500 PICKUP FLEETSIDE	C/K 3500 PICKUP FLEETSIDE
Head Room (in.)	HR	40.0	40.0	40.0	40.0
Leg Room (in.)	LR	41.7	41.7	41.7	41.7
Shoulder Room (in.)	SR	66.0	66.0	66.0	66.0
Hip Room (in.)	HP	60.7	60.7	60.7	60.7

FUEL TANK

Std. Tank Nominal (gal.)	25.0	34.0	34.0	34.0
Location of Tank	Inboard LH Frame Rail	Inboard LH Frame Rail	Inboard LH Frame Rail	Inboard LH Frame Rail
Location of Filler	Left Side	Left Side	Left Side	Left Side

C/K EXTENDED CAB MODELS

MODEL	C/K 1500 PICKUP FLEETSIDE		C/K 2500 PICKUP FLEETSIDE		C/K 3500 PICKUP FLEETSIDE	
MODEL NUMBER	CC10753/E63 CK10753/E63	CC10953/E63 CK10953/E63	CC20753/E63 CK20753/E63	CC20953/E63 CK20953/E63	CC30953/E63	CK30953/E63

INTERIOR

CAB		C/K 1500 PICKUP FLEETSIDE	C/K 2500 PICKUP FLEETSIDE	C/K 3500 PICKUP FLEETSIDE
Head Room (in.)	HR	40.0	40.0	40.0
Leg Room (in.)	LR	41.7	41.7	41.7
Shoulder Room (in.)	SR	66.0	66.0	66.0
Hip Room (in.)	HP	60.7	60.7	60.7
Extended Cab Cargo Volume (cu. ft.) w/o Rear Seat	CV	40.5	40.5	40.5

FUEL TANK

Std. Tank Nominal (gal.)	25.0	34.0	25.0	34.0	34.0
Location of Tank	Inboard LH Frame Rail		Inboard LH Frame Rail		Inboard LH Frame Rail
Location of Filler	Left Side		Left Side		Left Side

C/K EXTENDED CAB MODELS

MODEL		C/K 1500 PICKUP EXT. CAB FLEETSIDE		C/K 2500 PICKUP EXT. CAB FLEETSIDE			C/K 3500 PICKUP EXT. CAB FLEETSIDE
MODEL NUMBER		CC10753/E62 CK10753/E62	CC10953/E63 CK10953/E63	CC20753/E63 CK20753/E63	CC20953/E63 CK20953/E63		CC30953/E63 CK30953/E63
					C6P		
EXTERIOR DIMENSIONS							
BODY							
Wheelbase (in.)	WB	141.5	155.5	141.5	155.5	155.5	155.5
Overall Length (in.) w/o Rear Bumper	OAL	218.0	237.0	218.0	237.0	212.6	237.0
Overall Height (in.) Nominal	OAH	2WD 70.6 4WD 73.8		2WD 74.0 4WD 74.4	2WD 74.0 4WD 74.4	2WD 75.6 4WD 75.8	2WD 75.6 4WD 75.8
Maximum Width (in.)	OAW	76.8		76.8			94.2
Bumper to Axle Front (in.)	BA	34.9	34.9	34.9	34.9	34.9	34.9
Rear (in.)		47.27	52.2	47.27	52.2	52.2	52.2
Cab Axle (in.)	CA	41.8	55.9	41.8	55.9	55.9	55.9
Cab to End of Frame (in.)	—	78.7	97.6	78.7	97.6	97.6	97.6
Bumper to back of Cab (in.)	BBC	134.6		134.6			134.6
Ground To Top of Rear Load Flr. (in.)	GF	2WD 29.0 4WD 32.4		2WD 31.6 4WD 32.9	2WD 31.6 4WD 32.9	2WD 34.0 4WD 34.4	2WD 34.0 4WD 34.4
Ground Clearance (in.) Front/Rear	—	2WD 7.2/7.1 4WD 9.2/9.6		2WD 7.9/7.7 4WD 9.2/8.2	2WD 7.9/7.7 4WD 9.2/8.2	2WD 8.4/8.0 4WD 9.2/8.1	2WD 7.9/7.6 4WD 7.2/7.4
CARGO BOX							
Inside Length At Floor (in.)	IBL	78.7	97.6	78.6	97.6	97.6	97.6
Inside Width At Top Rear (in.)	IWR	61.9		61.9			61.9
Inside Width At Floor (in.)	IWF	64.7		64.7			64.7
Inside Width At Wheelhousing (in.)	IWW	49.1		49.1			49.1
Inside Height (in.)	—	19.3		19.3			19.3
Tailgate Width (in.) Top	—	62.0		62.0			62.0
SIGN PANEL AREA (in.)	Shaded Area	17 x 77 1/2		17 x 77 1/2			17 x 77 1/2

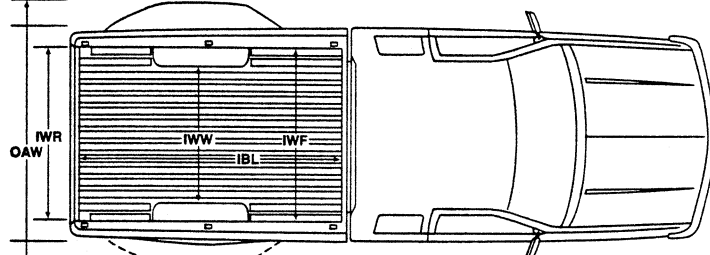
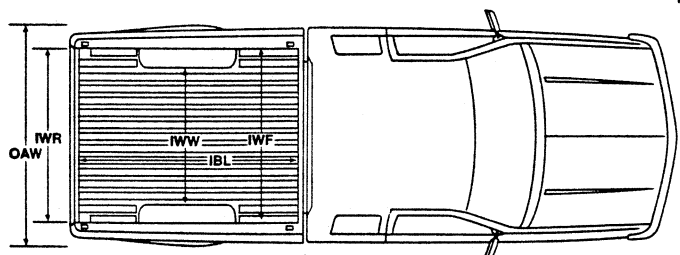
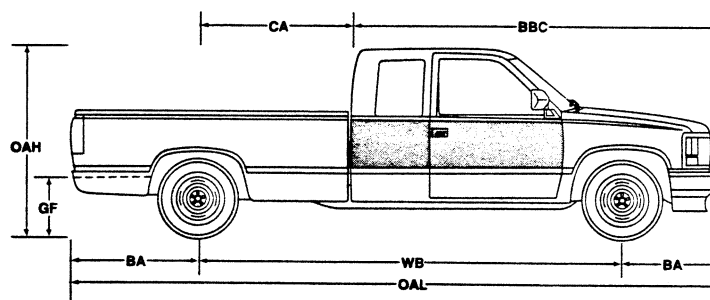
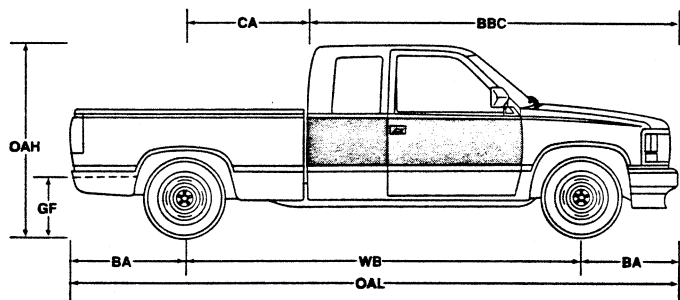

< PICKUP

- S - Standard
 - O - Optional
 - Not Available
- | | | | |
|----------------|-----------------|-----------------|-----------------|
| 1. CC10703/E62 | 6. CC20903/E63 | 11. CK10703/E62 | 16. CK20903/E63 |
| 2. CC10703/E63 | 7. CC20753/E63 | 12. CK10703/E63 | 17. CK20753/E63 |
| 3. CC10903/E63 | 8. CC20953/E63 | 13. CK10903/E63 | 18. CK20953/E63 |
| 4. CC10753/E63 | 9. CC30903/E63 | 14. CK10753/E63 | 19. CK30903/E63 |
| 5. CC10953/E63 | 10. CC30953/E63 | 15. CK10953/E63 | 20. CK30953/E63 |

JTE: Refer to Dealer Order Guide for Updated Option Availability.

				MODELS																			
				2-WHEEL DRIVE										4-WHEEL DRIVE									
				1	2	3	4	5	6	7	8	9	10	11	12	13	14	15	16	17	18	19	20
OPTION	CODE	DESCRIPTION	RESTRICTIONS																				
DEFOGGER	C49	Rear Window	N/A A28 Window or BYP Sport Pkg; Reqs YE9 Silverado or Z62 Scottsdale; N/A on WT1500 or 454SS	O	O	O	O	O	O	O	O	O	O	O	O	O	O	O	O	O	O	O	O
ENGINES		(See Powertrains)																					
4.3-liter V6 EFI	LB4			S	S	S	S	S	S	S	S	S	S	S	S	S	S	S	S	S	S	S	S
5.0-liter V8 EFI	L03			O	O	O	O	O	O	O	O	O	O	O	O	O	O	O	O	O	O	O	O
5.7-liter V8 EFI	L05			O	O	O	O	O	O	O	O	O	S	O	O	O	O	O	O	O	O	O	S
7.4-liter V8 EFI	L19		C/K2500 at 8600 GVWR only	-	O	-	-	O	-	O	O	O	O	-	-	-	-	-	-	-	O	O	O
6.2-liter V8 Diesel	LH6			-	-	O	O	O	O	O	O	O	O	-	-	O	O	O	O	O	O	O	O
6.2-liter V8 H.D. Diesel	LL4			-	-	-	-	O	O	O	O	O	O	-	-	-	-	O	O	O	O	O	O
FILLER CAP, FUEL	N05	Locking		O	O	O	O	O	O	O	O	O	O	O	O	O	O	O	O	O	O	O	O
GLASS																							
Deep Tinted	AJ1	Incls A20 Swing-Out Quarter Windows	N/A w/A28 Sliding Rear Windows or C49 Defogger; Ext Cab only	-	-	-	O	O	-	O	O	-	O	-	-	O	O	-	O	O	-	O	O
HARNES, WIRING	UY7	Trailer, Heavy-Duty 7-Lead; Incl w/Z82 Trailering		O	O	O	O	O	O	O	O	O	O	O	O	O	O	O	O	O	O	O	O
LAMPS																							
Cargo Area	UF2	Incl w/TR9 Lighting	N/A on WT1500	O	O	O	O	O	O	O	O	O	O	O	O	O	O	O	O	O	O	O	O
Dome and Reading	C95	Incl w/TR9 Lighting	N/A on WT1500	O	O	O	O	O	O	O	O	O	O	O	O	O	O	O	O	O	O	O	O
Roof Marker	U01	Incl w/R05 Wheels	N/A w/YF5 CA. Emissions; N/A on WT1500 or 454SS;	O	O	O	O	O	O	O	O	S	S	O	O	O	O	O	O	O	O	S	S
LICENSE PLATE BRACKET	VK3	Front		O	O	O	O	O	O	O	O	O	O	O	O	O	O	O	O	O	O	O	O
LIGHTING, AUXILIARY	TR9	Incls C95 Dome and Reading Lamps and Ashtray, Glove Box and Underhood Lamps	N/A on WT1500; Std on 454SS	O	O	O	O	O	O	O	O	O	O	O	O	O	O	O	O	O	O	O	O
MIRRORS, EXTERIOR (LH/RH)																							
Below-Eye-Line Type	D45	Stainless Steel, 9.0" x 6.5"	N/A on WT1500 or 454SS	O	O	O	O	O	O	O	O	O	O	O	O	O	O	O	O	O	O	O	O
Camper Type	DF2	Stainless Steel; Incl w/Z81 Camper; 7.5" x 10.5"		O	O	O	O	O	O	O	O	O	O	O	O	O	O	O	O	O	O	O	O
MOLDINGS																							
Body Side	B84	Black; Incl w/Z62 Scottsdale w/o BYP Sport Package	N/A w/BYP; N/A w/YE9 Silverado or B85 Moldings; N/A R05 Wheels; N/A on WT1500 or 454SS	O	O	O	O	O	O	O	O	O	O	O	O	O	O	O	O	O	O	O	O
Body Side	B85	Bright; Incl w/YE9 Silverado w/o BYP Sport Package	N/A Std Decor; N/A R05 Wheels; N/A B84 Moldings; N/A on WT1500 or 454SS	O	O	O	O	O	O	O	O	O	O	O	O	O	O	O	O	O	O	O	O
OFF-ROAD CHASSIS PACKAGE	Z71	Incls Bilstein Shocks and NZZ Skid Plate	Reqs XGL or XGM Tires; N/A F60 Springs or F51 Shocks	-	-	-	-	-	-	-	-	-	-	-	O	O	O	O	-	-	-	-	-
PAINT, EXTERIOR		(See Color and Trim)																					
Solid	ZY1			S	S	S	S	S	S	S	S	S	S	S	S	S	S	S	S	S	S	S	S
Conventional Two-Tone	ZY2		N/A on WT1500 or 454SS	O	O	O	O	O	O	O	O	O	O	O	O	O	O	O	O	O	O	O	O
Special Two-Tone	ZY3		N/A on WT1500 or 454SS	O	O	O	O	O	O	O	O	O	O	O	O	O	O	O	O	O	O	O	O
Deluxe Two-Tone	ZY4		N/A on WT1500 or 454SS	O	O	O	O	O	O	O	O	O	O	O	O	O	O	O	O	O	O	O	O

OPTIONS

- | | | | | | |
|-----|-----------------|----------------|-----------------|-----------------|-----------------|
| KEY | S - Standard | 1. CC10703/E62 | 6. CC20903/E63 | 11. CK10703/E62 | 16. CK20903/E63 |
| | O - Optional | 2. CC10703/E63 | 7. CC20753/E63 | 12. CK10703/E63 | 17. CK20753/E63 |
| | — Not Available | 3. CC10903/E63 | 8. CC20953/E63 | 13. CK10903/E63 | 18. CK20953/E63 |
| | | 4. CC10753/E63 | 9. CC30903/E63 | 14. CK10753/E63 | 19. CK30903/E63 |
| | | 5. CC10953/E63 | 10. CC30953/E63 | 15. CK10953/E63 | 20. CK30953/E63 |

NOTE: Refer to Dealer Order Guide for Updated Option Availability.

CODES																			
2-WHEEL DRIVE										4-WHEEL DRIVE									
1	2	3	4	5	6	7	8	9	10	11	12	13	14	15	16	17	18	19	20

OPTION	CODE	DESCRIPTION	RESTRICTIONS
AIR CONDITIONING	C60	Incls 100 Amp Alternator	w/L03 Eng and MX0 Trans. and 3.73 or 4.10 axle ratio req KC4 Eng Oil Cooler
ANALOG GAGES	U16	With Tachometer	Std on 454SS
AXLES, REAR Locking Differential	G80		
BATTERY Heavy Duty, Auxiliary	TP2	Delco Freedom 540 Cold Cranking Amps	N/A on WT1500 Incl w/Z81 Camper; N/A B3J Diesel Equipment
BEDLINER	BZY	Pickup Box	N/A P13 Wheel Carrier
BUMPER EQUIPMENT Bumper, Painted	V43	Rear Step	Reqs E63 Body
Bumper, Chromed	VB3	Rear Step w/Rub Strip	E63 Body reqs Z62 Scottsdale or YE9 Silverado or VG3
Bumper, Chromed	VG3	Front Deluxe w/Rub Strip	Avail w/E62 Sportside only; Incl w/Z62 Scottsdale or YE9 Silverado
Guards, Front Bumper	V27	Black	N/A on WT1500. E63 Body reqs YE9 Silverado or Z62 Scottsdale. E62 Body reqs VG3 Bumper.
CAMPER SPECIAL CHASSIS EQUIPMENT	Z81	Basic Camper Group Incls DF2 Mirrors, Camper Wiring Harness; also TP2 (H.D. Aux.) Battery w/o B3J Diesel Equipment	N/A D45 Mirrors; MX0 Trans. reqs V02 Cooling; MM4 or MM5 Trans. reqs V01 Cooling or C60 Air; w/o B3J Diesel and C6P reqs KC4 Cooling
CARRIER, SPARE WHEEL AND TIRE	P13	Side Mounted	N/A ZQ8 Sport Chassis, BZY Bedliner or w/ R05 Wheels
CHASSIS	F44	Heavy-Duty Incl w/B3J Diesel Equip	Reqs XCN, XFL, XFM or XFN Tires on C10903; K10703 reqs 3.42 Axle; N/A PF4 Wheels
COLD-CLIMATE PACKAGE	V10	Incls Engine Block Heater, Special Insulation and Anti-Freeze Protection to -32° F	N/A B3J Diesel
CONVENIENCE PACKAGE Driver's	ZQ3	Incls Electronic Speed Control and Comfortilt Steering Wheel	N/A WT1500; Std on 454SS
Operating	ZQ2	Incls Power Door Locks and Power Windows	N/A WT1500; Std on 454SS
COOLING SYSTEM Engine Oil Cooler	KC4		N/A w/B3J Diesel Engine. Reqs V02 Cooling w/MX0 Trans L05 or L19 Eng; Incl w/Z82 Trailering.
Radiator, Heavy-Duty	V01		N/A V02 Cooling; C1500 w/C60 Air reqs LH6 Diesel and 3.08 or 3.42 Axle (K1500 and C/K2500 w/C60 Air reqs LH6 and 3.42 only); LL4 Diesel reqs 3.73 Axle and KC4 Eng Oil Cooler on C/K2500; N/A WT1500 or 454SS; C/K2500 N/A w/LB4 Eng w/C6P; C/K3500 N/A w/C60, MX0 Trans reqs L05
Radiator and Transmission Oil Cooler, Heavy-Duty	V02		Reqs MX0 Trans Incl w/Z82 Trailering; N/A V01 Cooling; LB4 or L05 Eng and C60 Air reqs KC4 Eng Oil Cooler

K PICKUP

- S - Standard
 - O - Optional
 - Not Available
- | | | | |
|----------------|-----------------|-----------------|-----------------|
| 1. CC10703/E62 | 6. CC20903/E63 | 11. CK10703/E62 | 16. CK20903/E63 |
| 2. CC10703/E63 | 7. CC20753/E63 | 12. CK10703/E63 | 17. CK20753/E63 |
| 3. CC10903/E63 | 8. CC20953/E63 | 13. CK10903/E63 | 18. CK20953/E63 |
| 4. CC10753/E63 | 9. CC30903/E63 | 14. CK10753/E63 | 19. CK30903/E63 |
| 5. CC10953/E63 | 10. CC30953/E63 | 15. CK10953/E63 | 20. CK30953/E63 |

NOTE: Refer to Dealer Order Guide for Updated Option Availability.

MODELS																			
2-WHEEL DRIVE										4-WHEEL DRIVE									
1	2	3	4	5	6	7	8	9	10	11	12	13	14	15	16	17	18	19	20

OPTION	CODE	DESCRIPTION	RESTRICTIONS	1	2	3	4	5	6	7	8	9	10	11	12	13	14	15	16	17	18	19	20
TIRE EQUIPMENT		(See Wheels and Tires for Details)	(Spare Tire is Optional on C/K2500 and C/K3500 Models)																				
P225/75R15	XEV YEV ZEV			O	O	O																	
P225/75R15	XET YET ZET			S	S	S																	
P235/75R15	XFL YFL ZFL		XFL and YFL Tires req w/BYP w/o ZQ8	O	O	O	S	S															
P235/75R15	XFM YFM ZFM			O	O	O	O	O															
P235/75R15	XFN YFN ZFN			O	O	O	O	O															
P275/60R15	XCN YCN ZCN		Reqs ZQ8	O	O	O	O	O															
LT225/75R16C	XHE YHE ZHE		(Incls YHP or YHR Rear Tires only)								S	S	S	S	S								
LT225/75R16C	XHJ YHJ ZHJ													O	O	O							
LT225/75R16C	XHN YHN ZHN													O	O	O							
LT225/75R16D	XHP YHP ZHP						S	S	S	O	O					S			S		S		
LT225/7516D	XHR YHR ZHR															O				O		O	
LT245/75R16C	XBK YBK ZBK															S	S		S	S			
LT245/75R16C	XBN YBN ZBN															O	O		O	O			
LT245/75R16C	XBX YBX ZBX															O	O		O	O			
LT245/75R16E	XHH YHH ZHH		XHH Tires are opt w/YGK Rear Tires (C Models only)								O	O	O						O		O		
LT245/75R16E	XGK YGK ZGK																		O		O		
LT265/75R16C	XGL YGL ZGL		Std w/BYP Sport Package													O	O	O	O				
LT265/75R126C	XGM YGM ZGM															O	O	O	O				
7.50-16D	XDE YDE ZDE															O	O					O	O
7.50-16D	XDL YDL ZDL																					O	O

*Includes YHP or YHR Rear Tires on C Models Includes YHP Rear Tires only on K Models.

- KEY** S - Standard
O - Optional
— Not Available
- | | | | |
|----------------|-----------------|-----------------|-----------------|
| 1. CC10703/E62 | 6. CC20903/E63 | 11. CK10703/E62 | 16. CK20903/E63 |
| 2. CC10703/E63 | 7. CC20753/E63 | 12. CK10703/E63 | 17. CK20753/E63 |
| 3. CC10903/E63 | 8. CC20953/E63 | 13. CK10903/E63 | 18. CK20953/E63 |
| 4. CC10753/E63 | 9. CC30903/E63 | 14. CK10753/E63 | 19. CK30903/E63 |
| 5. CC10953/E63 | 10. CC30953/E63 | 15. CK10953/E63 | 20. CK30953/E63 |

NOTE: Refer to Dealer Order Guide for Updated Option Availability.

OPTION	CODE	DESCRIPTION	RESTRICTIONS	TIRES																			
				2-WHEEL DRIVE										4-WHEEL DRIVE									
				1	2	3	4	5	6	7	8	9	10	11	12	13	14	15	16	17	18	19	20
RADIO EQUIPMENT																							
AM Radio	U63		Opt on WT1500	S	S	S	S	S	S	S	S	S	S	S	S	S	S	S	S	S			
Radio Delete	UL5		Std on WT1500 Avail w/P.E.G., P1A1, P2A1, P3A1 only	O	O	O	O	O	O	O	O	O	O	O	O	O	O	O	O	O			
Electronically-Tuned AM/FM Stereo Radio w/Seek-Scan and Digital Clock	UM7	12 Presets, Digital Display, Two Front/Two Rear 4" x 6" ERS Speakers, 26 Watts Total Power Output	Incl w/YE9 Silverado	O	O	O	O	O	O	O	O	O	O	O	O	O	O	O	O	O			
Electronically-Tuned AM/FM Stereo Radio w/Seek-Scan, Stereo Cassette Tape and Digital Clock	UM6	12 Presets, Digital Display, Two Front/Two Rear 4" x 6" ERS Speakers, 26 Watts Total Power Output		O	O	O	O	O	O	O	O	O	O	O	O	O	O	O	O	O			
Electronically-Tuned AM Stereo/FM Stereo Radio w/Seek-Scan, Stereo Cassette Tape w/Search- Repeat, Graphic Equalizer and Digital Clock	UX1	12 Presets, Digital Display, Two Front/Two Rear ERS Speakers, 26 Watts Total Power Output		O	O	O	O	O	O	O	O	O	O	O	O	O	O	O	O	O			
SCOTTSDALE	Z62	(See Trim Level Section)	N/A on WT1500 or 454SS	O	O	O	O	O	O	O	O	O	O	O	O	O	O	O	O	O			
SEATS																							
Reclining High-Back, Front Bucket	A95		Std on 454SS; N/A on WT1500	O	O	O	-	-	O	-	-	O	-	-	O	-	-	O	-	-			
SHOCK ABSORBERS																							
Front/Rear, Heavy-Duty	F51	Incl w/Z82 Trailering	N/A Z71 Off-Road Chassis or ZQ8 Sport Suspension	O	O	O	O	O	-	-	-	-	O	O	O	O	-	-	-	-			
SILVERADO	YE9	(See Trim Level Section)	N/A on WT1500	O	O	O	O	O	O	O	O	O	O	O	O	O	O	O	O	O			
SKID PLATE	NZZ	Off-Road; Incl w/Z71 Off- Road Chassis Package		-	-	-	-	-	-	-	-	-	O	O	O	O	O	O	O	O			
SPORT EQUIPMENT PACKAGE	BYP	C10703 — Includes Up- level Black Grille, Composite Headlamps, Body Color Front Bumper, Body Color Rear Bumper w/Rub Strip and Step Pad, Fog Lamps, Special Body Side Moldings, Chrome Plated 15.0" Wheels, Black Mirrors and Sport Identification Decals K10703 — Includes Up- level Black Grille, Composite Headlamps, Black Front Bumper, Black Rear Bumper w/Step Pad, Black Mirrors, Black Wheel Flares, Aluminum Wheels and 4x4 Sport Identification Decals	Reqs P235/75R15 Tires without ZQ8 Sport Suspension ZQ8 reqs P275/60R15 Tires Reqs LT265/75R16C Tires	O	O	-	-	-	-	-	-	-	-	-	-	-	-	-	-	-			
SPORT PERFORMANCE PACKAGE	B4U	(See Trim Level Section)	N/A on WT1500	-	O	-	-	-	-	-	-	-	-	-	-	-	-	-	-	-			
SPRINGS (TORSION BARS)	F60	Front, Heavy-Duty	N/A w/Diesel Eng, w/Z71 Off- Road Chassis Package or with 454SS. K1500 Series Reg Cab reqs F44 H.D. Chassis	-	-	-	-	-	-	-	-	-	O	O	O	O	O	O	O	O			
STEERING WHEEL, SPORT	NK3		Reqs YE9 Silverado; N/A on WT1500	O	O	O	O	O	O	O	O	O	O	O	O	O	O	O	O	O			
STRIPING	D85	(See Color and Trim)	Reqs ZY1 or ZY2 Paint; N/A on WT1500 or 454SS	O	O	O	O	O	O	O	O	O	O	O	O	O	O	O	O	O			
SUSPENSION, SPORT	ZQ8	Incls Bilstein Gas-Filled Shocks and 12.7:1 Ratio Steering	Reqs XCN Tires; LB4 or L05 Engine reqs 3.42 or 3.73 Rear Axle; N/A F51 Shocks, P13 Carrier, P01 Wheel Covers, N90 Wheels, B3J or WT1500	O	O	O	O	O	-	-	-	-	-	-	-	-	-	-	-	-			

SOLID COLOR (ZY1)

Solid color paint (ZY1) is standard on all models. All painted areas of the cab, front end sheet metal, and box are the same color. Outlined block "Chevrolet" decal lettering is applied to the tailgate. (A bright trim plate with lettering is applied on Fleetside models when the Silverado trim is ordered). The only available Color Code 1/Color Code 2 exterior paint combinations are those displayed in the chart below. Recommended interior trim colors are indicated by the symbol ●. For more information, refer to Seats and Interior Trim pages as well as the Truck Order Guide.

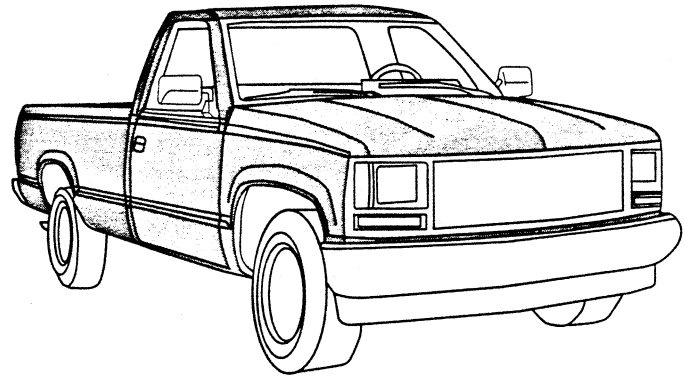

KEY: ●—Recommended ●—Not Available on C/K Extended Cab.

EXTERIOR COLORS		STRIPE COLORS	INTERIOR COLORS				
COLOR CODE 1	COLOR CODE 2	w/D85	Beige	Blue	Garnet	Gray	Saddle
22 Brilliant Blue Met.	22 Brilliant Blue Metallic	Lt. Blue		●			
27 Smoke Blue Met.	27 Smoke Blue Metallic	Lt. Blue		●			
	27 Smoke Blue Metallic	Silver				●	
30 Catalina Blue Met.	30 Catalina Blue Metallic	Lt. Blue		●			
	30 Catalina Blue Metallic	Silver				●	
41 Onyx Black	41 Onyx Black	Silver				●	
	41 Onyx Black	Gold					●
	41 Onyx Black	Lt. Blue		●			
	41 Onyx Black	Vermillion			●		
	41 Onyx Black	Lt. Beige		●			
50 Summit White	50 Summit White	Lt. Blue		●			
	50 Summit White	Gold					●
	50 Summit White	Vermillion			●		
	50 Summit White	Silver				●	
	50 Summit White	Lt. Beige		●			
58 Sandstone Met.	58 Sandstone Metallic	Vermillion	●				
70 Flame Red	70 Flame Red	Gold					●
	70 Flame Red	Vermillion			●		
	70 Flame Red	Silver				●	
94 Crimson Red Met.	94 Crimson Red Metallic	Gold					●
	94 Crimson Red Metallic	Silver				●	
	94 Crimson Red Metallic	Lt. Beige	●				
	94 Crimson Red Metallic	Vermillion			●		
96 Quicksilver Met.	96 Quicksilver Metallic	Lt. Blue		●			
	96 Quicksilver Metallic	Vermillion			●	●	
97 Slate Met.	97 Slate Metallic	Vermillion			●		
	97 Slate Metallic	Silver				●	

- KEY S - Standard
O - Optional
— Not Available
- | | | | |
|----------------|-----------------|-----------------|-----------------|
| 1. CC10703/E62 | 6. CC20903/E63 | 11. CK10703/E62 | 16. CK20903/E63 |
| 2. CC10703/E63 | 7. CC20753/E63 | 12. CK10703/E63 | 17. CK20753/E63 |
| 3. CC10903/E63 | 8. CC20953/E63 | 13. CK10903/E63 | 18. CK20953/E63 |
| 4. CC10753/E63 | 9. CC30903/E63 | 14. CK10753/E63 | 19. CK30903/E63 |
| 5. CC10953/E63 | 10. CC30953/E63 | 15. CK10953/E63 | 20. CK30953/E63 |

NOTE: Refer to Dealer Order Guide for Updated Option Availability.

OPTION	CODE	DESCRIPTION	RESTRICTIONS	MODELS																																				
				2-WHEEL DRIVE										4-WHEEL DRIVE																										
				1	2	3	4	5	6	7	8	9	10	11	12	13	14	15	16	17	18	19	20																	
TOW HOOKS	V76	Front	N/A w/454SS	O	O	O	O	O	O	O	O	O	O	O	O	O	O	O	O	O	S	S	S	S	S	S	S	S	S	S	S	S	S	S	S	S	S	S	S	S
TRAILERING SPECIAL EQUIPMENT, HEAVY-DUTY	Z82	Incls Wiring Harness, Platform Hitch, V02 H.D. Trans Oil Cooler, and F51 Shocks; Incls KC4 Cooler w/o B3J Diesel Equip; w/o Z71 or ZQ8 Incls Shock Absorbers; w/Z71 or ZQ8 Incls Bilstein Shocks	3.08 Rear Axle N/A w/LB4 Engine; Reqs MX0 Trans; Also reqs VB3 or V43 Bumper except on C/K10703, C/K10753 and C/K19053	O	O	O	O	O	O	O	O	O	O	O	O	O	O	O	O	O	O	O	O	O	O	O	O	O	O	O	O	O	O	O	O	O	O	O	O	O
TRANSMISSIONS		(See Powertrains)																																						
	MM4	4-Speed Manual	N/A on WT1500	-	-	O	O	O	O	O	O	O	O	S	S	O	O	O	O	O	O	O	O	O	O	O	O	O	O	O	O	O	O	O	O	O	O	O	O	
	MM5	5-Speed Manual w/Overdrive		S	S	S	S	S	S	S	S	S	S	S	S	-	-	S	S	S	S	S	S	S	S	S	S	S	S	S	S	S	S	S	S	S	S	S		
	MM5 ¹	Heavy-Duty 5-Speed Manual Overdrive	Std on C/K1500 and C/K2500 Models w/B3J and C/K2500 Models w/C6P. Std on 454SS; N/A on WT1500	O	O	O	O	O	O	O	O	O	O	O	O	O	O	O	O	O	O	O	O	O	O	O	O	O	O	O	O	O	O	O	O	O	O	O	O	O
	MX0	4-Speed Automatic w/Overdrive		O	O	O	O	O	O	O	O	O	O	O	O	O	O	O	O	O	O	O	O	O	O	O	O	O	O	O	O	O	O	O	O	O	O	O	O	O
WHEEL TRIM																																								
Wheel Covers	P01		N/A w/454SS, YE9 Silverado, Z62 Scottsdale or ZQ8 Sport Suspension; N/A w/R05 Wheels	O	O	O	O	O	O	O	O	O	O	O	O	O	O	O	O	O	O	O	O	O	O	O	O	O	O	O	O	O	O	O	O	O	O	O	O	O
Trim Rings	P06			-	-	-	-	-	-	-	-	-	-	-	-	O	O	-	-	-	-	-	-	-	-	-	-	-	-	-	-	-	-	-	-	-	-	-		
WHEELS																																								
Aluminum, 15.0" x 7.0"	N90		N/A ZQ8, WT1500 or 454SS	O	O	O	O	O	O	-	-	-	-	-	-	-	-	-	-	-	-	-	-	-	-	-	-	-	-	-	-	-	-	-	-	-	-	-	-	
Aluminum, 16.0" x 7.0"	PF4	Incl w/BYP Sport Package	N/A F44 H.D. Chassis, WT1500 or B3J Diesel	-	-	-	-	-	-	-	-	-	-	-	-	-	-	-	-	-	O	O	-	-	-	-	-	-	-	-	-	-	-	-	-	-	-	-	-	
WHEELS																																								
Dual Rear	R05	Incls U01 Lamps Incl with B3J Diesel Equipment	MX0 Trans reqs V02 Heavy-Duty Radiator and Trans Oil Cooler	-	-	-	-	-	-	-	-	-	-	-	-	O	O	-	-	-	-	-	-	-	-	-	-	-	-	-	-	-	-	-	-	-	-	-		
WINDOWS																																								
Sliding Rear	A28		N/A C49 Defogger	O	O	O	O	O	O	O	O	O	O	O	O	O	O	O	O	O	O	O	O	O	O	O	O	O	O	O	O	O	O	O	O	O	O	O	O	O
WORK TRUCK PACKAGE	VLA	(See Trim Level Section)		-	-	O	-	-	-	-	-	-	-	-	-	-	-	-	-	-	-	-	O	-	-	-	-	-	-	-	-	-	-	-	-	-	-	-	-	

¹Available interim 1991. Check Order Guide for Notification of Availability.

■ The paint samples below are representative of the exterior colors offered on the C/K Pickup. Refer to the Color and Trim availability charts to determine specific availability. Red indicates a new color for 1991.

22 BRILLIANT BLUE MET.

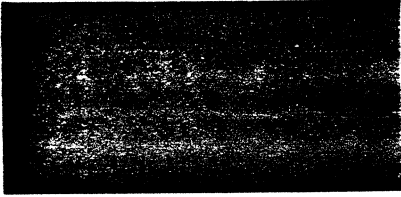

27 SMOKE BLUE MET.

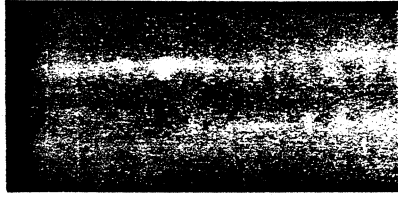

30 CATALINA BLUE MET.

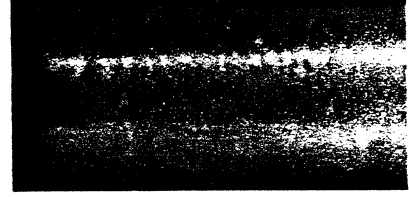

41 ONYX BLACK

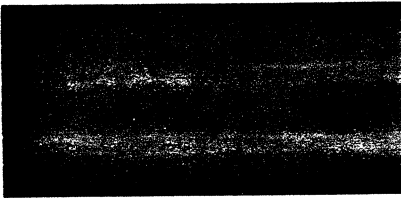

50 SUMMIT WHITE



58 SANDSTONE MET.

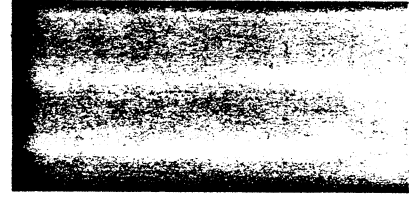

70 FLAME RED

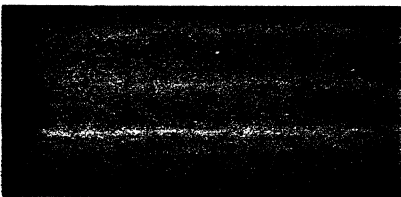

94 CRIMSON RED MET.

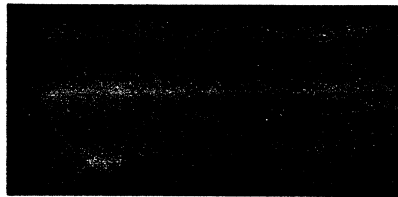

96 QUICKSILVER MET.



97 SLATE MET.

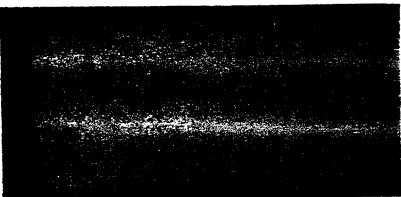



Colors

C/K PICKUP

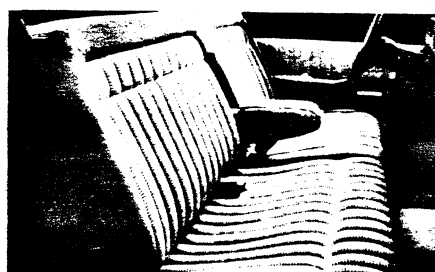

■ FULL FRONT BENCH SEAT

PASSENGER CAPACITY: 3

TRIM: Cheyenne (Std); Scottsdale (Z62); Silverado (YE9)

AVAILABILITY: Regular Cab; Extended Cab

ORDERING CODE: ***1

The standard foam bench seat features full width, full depth and will seat three passengers. It is available in Vinyl or Cloth for the Cheyenne (Std) Regular and Extended Cab models; in Cloth or Custom Vinyl for the Scottsdale (Z62) Regular Cab and Extended Cab models; or Custom Vinyl in the Silverado (YE9) Regular Cab only.

■ FULL FRONT BENCH SEAT

PASSENGER CAPACITY: 3

TRIM: Silverado (YE9) Custom Cloth only

AVAILABILITY: Regular Cab

ORDERING CODE: ***1

This seat features a folding armrest. It is standard when Custom Cloth is ordered with the Silverado (YE9) trim for Regular Cab models.

■ 60/40 SPLIT FRONT BENCH SEAT

PASSENGER CAPACITY: 3

TRIM: Cheyenne (Std) (Extended Cab only); Scottsdale (Z62); Silverado (YE9)

AVAILABILITY: Regular Cab; Extended Cab

ORDERING CODE: ***3

The foam bench seat features full width, full depth and includes a folding backrest. It seats three passengers and will split to allow each portion of the seats to fold individually. It is available in Vinyl or Cloth for the Cheyenne (Std) Extended Cab, Custom Vinyl for the Scottsdale (Z62) Regular Cab and Cloth or Custom Vinyl for the Scottsdale (Z62) Extended Cab. The Silverado (YE9) Regular Cab and Extended Cab are available in Custom Vinyl and Custom Cloth.

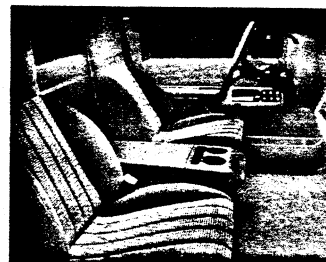
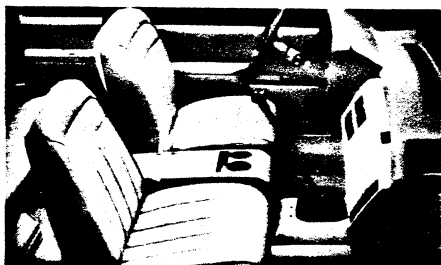

■ LOW-BACK FRONT BUCKET SEATS (DRIVER AND PASSENGER)

PASSENGER CAPACITY: 2

TRIM: Scottsdale (Z62); Silverado (YE9)

AVAILABILITY: Regular Cab; Extended Cab

ORDERING CODE: ***2

These optional bucket seats have foam padding and folding backrests with inertia latches. A Center Floor Console is included. It is available in Custom Vinyl for the Scottsdale (Z62), Regular and Extended Cab; Custom Vinyl and Custom Cloth for the Silverado (YE9), Regular and Extended Cab.

■ REAR BENCH SEAT

PASSENGER CAPACITY: 3

TRIM: Cheyenne (Std); Scottsdale (Z62); Silverado (YE9)

AVAILABILITY: Extended Cab models only

ORDERING CODE: Included with Bucket Seats or Split Bench Seat

This seat is included when choosing Bucket or Split Bench seats. It is a three passenger bench seat that also folds up to accommodate cargo. Seat trim will match front seat trim ordered.

■ RECLINING HIGH-BACK FRONT BUCKET SEATS

PASSENGER CAPACITY: 2

TRIM: Silverado (YE9)

AVAILABILITY: Regular Cab only

ORDERING CODE: (**6/A95)

These foam padded high-back bucket seats include a center floor console. They are available in Custom Cloth only.

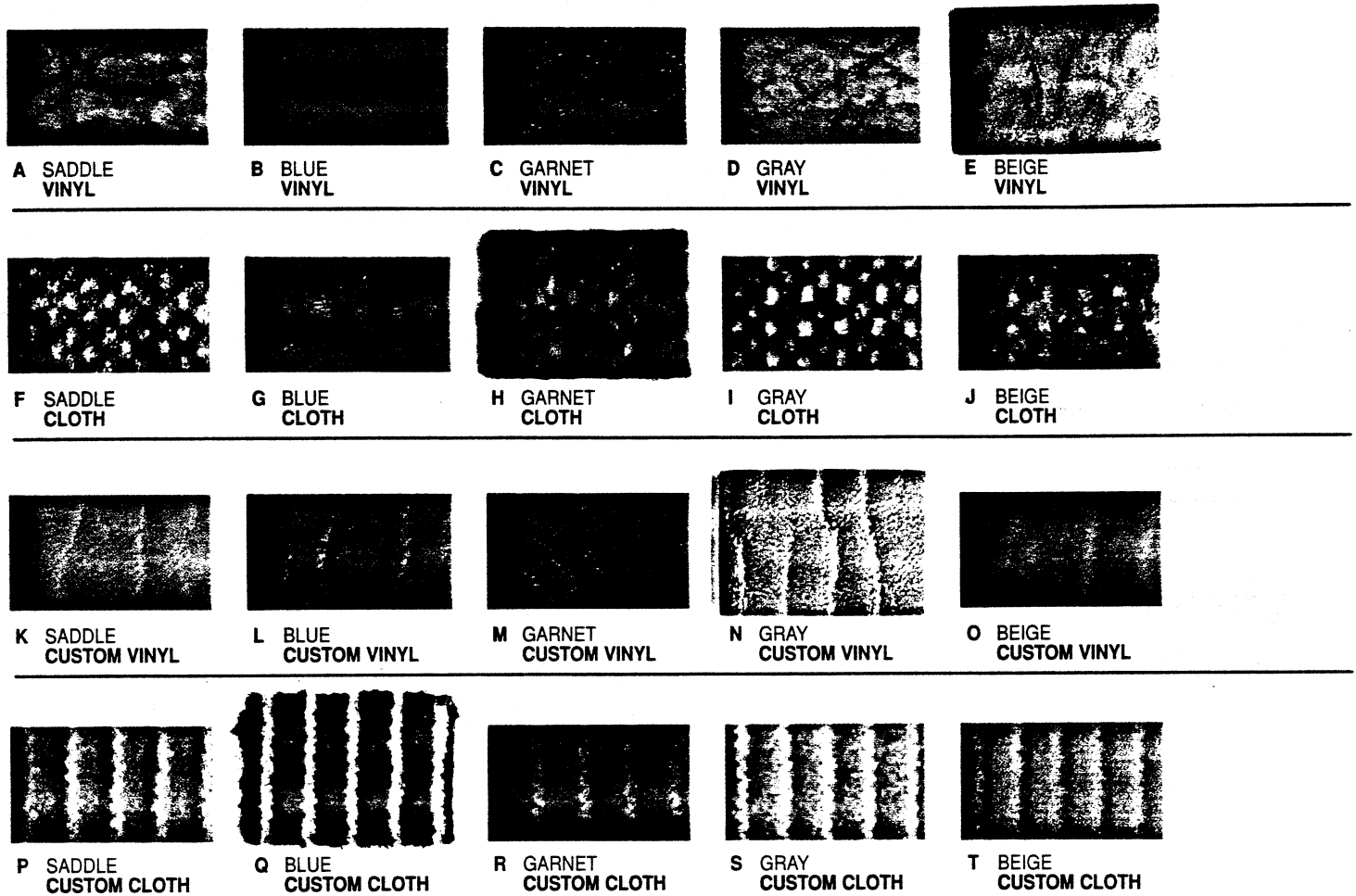

TRIM, SEAT AND INTERIOR COLOR SELECTION

MODEL	REGULAR CAB			EXTENDED CAB		
TRIM (Code)	CHEYENNE (Std)	SCOTTSDALE (Z62)	SILVERADO (YE9)	CHEYENNE (Std)	SCOTTSDALE (Z62)	SILVERADO (YE9)
SEAT (Code)	BENCH (***)	BENCH (***)	BENCH (***)	BENCH (***)	BENCH (***)	
Interior Color Availability	A Saddle Vinyl B Blue Vinyl C Garnet Vinyl D Gray Vinyl E Beige Vinyl F Saddle Cloth G Blue Cloth H Garnet Cloth I Gray Cloth J Beige Cloth	F Saddle Cloth G Blue Cloth H Garnet Cloth I Gray Cloth J Beige Cloth K Saddle Custom Vinyl L Blue Custom Vinyl M Garnet Custom Vinyl N Gray Custom Vinyl O Beige Custom Vinyl	K Saddle Custom Vinyl L Blue Custom Vinyl M Garnet Custom Vinyl N Gray Custom Vinyl O Beige Custom Vinyl P Saddle Custom Cloth Q Blue Custom Cloth R Garnet Custom Cloth S Gray Custom Cloth T Beige Custom Cloth	A Saddle Vinyl B Blue Vinyl C Garnet Vinyl F Saddle Cloth G Blue Cloth H Garnet Cloth	F Saddle Cloth G Blue Cloth H Garnet Cloth K Saddle Custom Vinyl L Blue Custom Vinyl M Garnet Custom Vinyl	
SEAT (Code)		SPLIT BENCH (***)	SPLIT BENCH (***)	SPLIT BENCH (***)	SPLIT BENCH (***)	SPLIT BENCH (***)
Interior Color Availability		K Saddle Custom Vinyl L Blue Custom Vinyl M Garnet Custom Vinyl	K Saddle Custom Vinyl L Blue Custom Vinyl M Garnet Custom Vinyl P Saddle Custom Cloth Q Blue Custom Cloth R Garnet Custom Cloth	A Saddle Vinyl B Blue Vinyl C Garnet Vinyl F Saddle Cloth G Blue Cloth H Garnet Cloth	F Saddle Cloth G Blue Cloth H Garnet Cloth K Saddle Custom Vinyl L Blue Custom Vinyl M Garnet Custom Vinyl	K Saddle Custom Vinyl L Blue Custom Vinyl M Garnet Custom Vinyl P Saddle Custom Cloth Q Blue Custom Cloth R Garnet Custom Cloth
SEAT (Code)		BUCKET SEAT (***)	BUCKET SEAT (***)		BUCKET SEAT (***)	BUCKET SEAT (***)
Interior Color Availability		K Saddle Custom Vinyl L Blue Custom Vinyl M Garnet Custom Vinyl	K Saddle Custom Vinyl L Blue Custom Vinyl M Garnet Custom Vinyl P Saddle Custom Cloth Q Blue Custom Cloth R Garnet Custom Cloth S Gray Custom Cloth		K Saddle Custom Vinyl L Blue Custom Vinyl M Garnet Custom Vinyl	K Saddle Custom Vinyl L Blue Custom Vinyl M Garnet Custom Vinyl P Saddle Custom Cloth Q Blue Custom Cloth R Garnet Custom Cloth
SEAT (Code)			RECLINING HIGH-BACK BUCKET SEATS (***)	FOLDING REAR BENCH¹	FOLDING REAR BENCH¹	FOLDING REAR BENCH¹
Interior Color Availability			P Saddle Custom Cloth Q Blue Custom Cloth R Garnet Custom Cloth S Gray Custom Cloth	Will Match Front Trim Ordered	Will Match Front Trim Ordered	Will Match Front Trim Ordered

¹Included when ordering Split Bench or Bucket Seats

2 WHEEL DRIVE DIESEL-POWERED FULL-SIZE PICKUPS

Trailer Classification	Light			Medium			Heavy			
Gross Trailer Weight (lbs.) up to ¹	2000			4000			5000	6000	8000	8000
Maximum Tongue Load (lbs.)	200			400			600	700	1000	1000
Series	C1500	C2500	C3500	C1500	C2500	C3500	C1500	C2500	C2500/C6P	C3500
Engine										
6.2L (379) V8 Diesel	LH6	LH6	LL4	LH6	LH6	LL4	LH6	LH6	LL4	LL4
Transmission, Automatic (4 Speed w/Overdrive)	MX0	MX0	MX0	MX0	MX0	MX0	MX0	MX0	MX0	MX0
Minimum Axle Ratio (to 1) (Gross Trailer Weight [lbs.])	3.08	3.42	4.10	3.42	3.42	4.10	3.42	3.42 (5000)	4.10 (6500)	4.10 (6500)
	—	—	—	—	—	—	—	3.73 (6000)	4.56 (8000)	4.56 (8000)
Trailer Special Package	—	—	—	Z82	Z82	Z82	Z82	Z82	Z82	Z82
Bumper, Rear Step Type	V43/VB3	V43/VB3	V43/VB3	—	—	—	—	—	—	—
Cooler, Engine Oil	Std.	Std.	Std.	Std.	Std.	Std.	Std.	Std.	Std.	Std.
Cooler, Transmission Oil	NR	NR	V02 ²	V02 ²	V02 ²	V02 ²	V02 ²	V02 ²	V02 ²	V02 ²
Cooling, Heavy-Duty	Std.	Std.	Std.	Std.	Std.	Std.	Std.	Std.	Std.	Std.
Mirrors, Camper Type	NR	NR	NR	DF2	DF2	DF2	DF2	DF2	DF2	DF2
Electronic Speed Control/Comfortilt Steering	NR	NR	NR	ZQ3	ZQ3	ZQ3	ZQ3	ZQ3	ZQ3	ZQ3

4 WHEEL DRIVE GASOLINE-POWERED FULL-SIZE PICKUPS

Trailer Classification	Light			Medium			Heavy			
Gross Trailer Weight (lbs.) up to ²	2000			4000			7500	8500	9500	10,000
Maximum Tongue Load (lbs.)	200			400			900	950	1000	1000
Series	K1500	K2500	K3500	K1500	K2500	K3500	K1500	K2500	K2500/C6P	K3500
Minimum Engine										
4.3L (262) V6 EFI	LB4	LB4	—	LB4	LB4	—	—	—	—	—
5.0L (305) V8 EFI	—	—	—	—	—	—	L03	L03	—	—
5.7L (350) V8 EFI	—	—	L05	—	—	L05	L05	L05	L05	L05
7.4L (454) V8 EFI	—	—	L19	—	—	L19	—	—	L19	L19
Transmission, Automatic (4 Speed w/Overdrive)	MX0	MX0	MX0	MX0	MX0	MX0	MX0	MX0	MX0	MX0
Minimum Axle Ratio (to 1) (Gross Trailer Weight [lbs.]) w/Minimum Engine	3.42	3.42	—	3.42	3.42	—	3.42 (6000)	3.42 (5500)	—	—
	—	—	—	—	—	—	3.73 (7000)	3.73 (6500)	—	—
w/5.7L V8 Engine	—	—	4.10	—	—	4.10	3.42 (6500)	3.73 (7000)	4.10 (8000)	4.10 (8000)
	—	—	—	—	—	—	3.73 (7500)	4.10 (8500)	4.56 (9500)	4.56 (9500)
w/7.4L V8 Engine	—	—	3.42	—	—	3.42	—	—	—	3.73 (9000)
	—	—	—	—	—	—	—	—	—	4.10 (10,000)
Trailer Special Package	—	—	—	Z82	Z82	Z82	Z82	Z82	Z82	Z82
Bumper, Rear Step Type	V43/VB3	V43/VB3	V43/VB3	—	—	—	—	—	—	—
Cooler, Engine Oil	NR	NR	NR	KC4 ²	KC4 ²	KC4 ²	KC4 ²	KC4 ²	KC4 ²	KC4 ²
Cooler, Transmission Oil	NR	NR	NR	V02 ²	V02 ²	V02 ²	V02 ²	V02 ²	V02 ²	V02 ²
Cooling, Heavy-Duty	V01	V01	V01	V01	V01	V01	NR	NR	NR	NR
Mirrors, Camper Type	NR	NR	NR	DF2	DF2	DF2	—	—	—	—
Electronic Speed Control/Comfortilt Steering	NR	NR	NR	ZQ3	ZQ3	ZQ3	ZQ3	ZQ3	ZQ3	ZQ3

¹ If you order more than the minimum required equipment or carry more than 2 passengers, the additional weight must be subtracted from the maximum trailer weight.

² Included in Trailering Special Package, RPO Z82.

NOTE: Model and driveline combinations must be verified by your local dealer for correct emissions equipment.

NR—Not Required.

SPECIAL TRAILERING PACKAGES

The charts below indicate the required and recommended options for towing light, medium or heavy trailers with your new C/K Full-Size Pickup. They also provide Regular Production Option numbers (RPOs) to make ordering easy for you.

As the charts show, a Heavy-Duty Special Trailering Package (RPO Z82) is recommended or required, depending on the C/K series and the size of the trailer to be towed. The package includes:

- A weight-distributing hitch platform.
- A 7-wire wiring harness.
- A transmission oil cooler (RPO V02).
- Heavy-duty front and rear shock absorbers (1500 Series only).
- An engine oil cooler (RPO KC4) for gasoline-powered models.

For towing a light trailer (up to 2000-lbs. gross weight), the optional rear step bumper is an appropriate deadweight hitch, and requires a 1⁷/₈"-diameter hitch ball, available as an accessory.

For towing a medium trailer (up to 4000-lbs. gross weight, or with a tongue

weight of 400-lbs. or under), a 2"- diameter hitch ball (also available as an accessory) is required for the C/K's rear step bumper.

For towing a heavy trailer (up to 10,000-lbs. gross weight), a weight-distributing hitch platform is required. It's included in RPO Z82—Heavy-Duty Trailering Special Package—or from an outside supplier. If you plan to "fifth wheel" a trailer with a gross weight of up to 13,500-lbs., please take special note of the following:

There are two types of pickup fifth-wheel hitch installations. The first has the fifth wheel on a bar mounted on brackets attached to the frame and the bed of the pickup and supported by braces on the fender housings.

Note: Diagonal bracing between the brackets is required. The kingpin is mounted on the trailer. With the second type, the kingpin is mounted in the bed of the pickup box, and the fifth wheel is mounted on the trailer. This type of hitch is supplied and installed by the trailer manufacturer.

Fifth-wheel trailers have a greater percentage of their weight on the kingpin (tongue load) than a conventional trailer. Because

of this fact, greater attention must be given to the maximum allowable payload and GVWR. The maximum allowable payload and GVWR for each application should not be exceeded. The weight of any additional equipment and all passengers must be subtracted from the payload weight to determine the available kingpin load.

You will also have to splice a wiring harness into your Pickup's special connector to activate your trailer lights and other electrical systems. A 5-wire wiring harness is sufficient for light trailers and can be purchased from an outside supplier. For medium and heavy trailers, a 7-wire wiring harness is required. It's included in RPO Z82 (Heavy-Duty Trailering Package) or can be purchased separately from an outside supplier. The heavy-duty 7-wire harness necessary for fifth-wheel trailering can be purchased from an outside supplier.

Although C/K Pickups can be purchased with manual transmissions for towing purposes, Chevrolet strongly endorses the 4-speed automatic transmission. The charts indicate trailering equipment required in **bold type**.

5-WHEEL DRIVE GASOLINE POWERED FULL SIZE PICKUPS

Trailer Classification	Light			Medium			Heavy			
Gross Trailer Weight (lbs.) up to ¹	2000			4000			7500	9000	10,000	10,000
Maximum Tongue Load (lbs.)	200			400			850	1000	1000	1000
Series	C1500	C2500	C3500	C1500	C2500	C3500	C1500	C2500	C2500/C6P	C3500
Minimum Engine										
4.3L (262) V6 EFI	LB4	LB4	—	LB4	LB4	—	—	—	—	—
5.0L (305) V8 EFI	—	—	—	—	—	—	L03	L03	—	—
5.7L (350) V8 EFI	—	—	L05	—	—	L05	L05	L05	L05	L05
7.4L (454) V8 EFI	—	—	L19	—	—	L19	—	—	L19	L19
Transmission, Automatic (4 Speed w/overdrive)	MX0	MX0	MX0	MX0	MX0	MX0	MX0	MX0	MX0	MX0
Minimum Axle Ratio (to 1) (Gross Trailer Weight [lbs.] w/Minimum Engine	3.08	3.42	—	3.08	3.42	—	3.42 (6000)	3.73 (7000)	—	—
	—	—	—	—	—	—	—	4.10 (8000)	—	—
w/5.7L V8 Engine	—	—	4.10	—	—	4.10	3.42 (6500)	3.73 (7500)	4.10 (8500)	4.10 (8500)
	—	—	—	—	—	—	3.73 (7500)	4.10 (9000)	4.56 (10,000)	4.56 (10,000)
w/7.4L V8 Engine	—	—	3.42	—	—	3.42	—	—	3.73 (9500)	3.73 (9500)
	—	—	—	—	—	—	—	—	4.10 (10,000)	4.10 (10,000)
Trailering Special Package	—	—	—	Z82	Z82	Z82	Z82	Z82	Z82	Z82
Bumper, Rear Step Type	V43/VB3	V43/VB3	V43/VB3	—	—	—	—	—	—	—
Cooler, Engine Oil	NR	NR	NR	KC4 ²	KC4 ²	KC4 ²	KC4²	KC4²	KC4²	KC4²
Cooler, Transmission Oil	NR	NR	NR	V02	V02 ²	V02 ²	V02²	V02²	V02²	V02²
Cooling, Heavy-Duty	V01	V01	V01	V01	V01	V01	—	—	—	—
Mirrors, Camper Type	NR	NR	NR	DF2	DF2	DF2	DF2	DF2	DF2	DF2
Electronic Speed Control/Comfortilt Steering	NR	NR	NR	ZQ3	ZQ3	ZQ3	ZQ3	ZQ3	ZQ3	ZQ3

¹ If you order more than the minimum required equipment or carry more than 2 passengers, the additional weight must be subtracted from the maximum trailer weight.

² Included in Trailering Special Package, RPO Z82.

NOTE: Model and driveline combinations must be verified by your local dealer for correct emissions equipment.

NR—Not Required.

**2-WHEEL DRIVE AND 4-WHEEL DRIVE DIESEL-POWERED
FULL-SIZE PICKUPS—FIFTH WHEEL WITH KINGPIN-TYPE HITCH**

Trailer Classification	Heavy	Heavy	Heavy	Heavy	Heavy	Heavy
Gross Trailer Weight (lbs.) up to ¹	6000	8000	8000	6500	7500	7500
Series	C2500	C2500/C6P	C3500	K2500	K2500/C6P	K3500
Engine						
6.2L (379) V8 Diesel	LH6	LL4	LL4	LH6	LL4	LL4
Maximum GVWR (lbs.)	7200	8600	10,000	7200	8600	10,000
Transmission, Automatic ² (4 Speed w/Overdrive)	MX0	MX0	MX0	MX0	MX0	MX0
Minimum Axle Ratio (to 1) (Gross Trailer Weight [lbs.])	3.42 (5000)	3.73 (5500)	4.10 (6500)	3.42 (4500)	3.73 (5000)	4.10 (6000)
	3.73 (6000)	4.10 (6500)	4.56 (8000)	3.73 (5500)	4.10 (6000)	4.56 (7500)
	—	4.56 (8000)	—	4.10 (6500)	4.56 (7500)	—
Cooler, Engine Oil	Std.	Std.	Std.	Std.	Std.	Std.
Cooler, Transmission Oil	V02	V02	V02	V02	V02	V02
Cooling, Heavy-Duty	Std.	Std.	Std.	Std.	Std.	Std.
Mirrors, Camper Type	DF2	DF2	DF2	DF2	DF2	DF2
Electronic Speed Control/ Comfortilt Steering	ZQ3	ZQ3	ZQ3	ZQ3	ZQ3	ZQ3

**COMMERCIAL—2-WHEEL DRIVE AND 4-WHEEL DRIVE GASOLINE-
AND DIESEL-POWERED FULL-SIZE PICKUPS—CONVENTIONAL TRAILER**

Trailer Classification	C/K REGULAR CAB		C/K REGULAR CAB	
	Heavy		Heavy	
Gross Trailer Weight (lbs.) up to ¹	10,000	10,000	9000	8500
Maximum Tongue Load (lbs.)	1000	1000	1000	950
Series	C3500	K3500	C3500	K3500
Minimum Engine				
5.7L (350) V8 EFI	L05	L05	—	—
7.4L (454) V8 EFI	L19	L19	—	—
6.2L (379) V8 Diesel	—	—	LL4	LL4
Transmission, Automatic (4 Speed w/Overdrive)	MX0	MX0	MX0	MX0
Minimum Axle Ratio (to 1) (Gross Trailer Weight [lbs.]) w/5.7L V8 Engine	4.10 (8500)	4.10 (8000)	—	—
	4.56 (10,000)	4.56 (9500)	—	—
	3.42 (8500)	3.42 (8000)	—	—
w/7.4L V8 Engine	3.73 (9500)	3.73 (9000)	—	—
	4.10/4.56 (10,000)	4.10/4.56 (10,000)	—	—
	—	—	4.10 (7500)	4.10 (7000)
w/6.2L V8 Diesel	—	—	4.56 (9000)	4.56 (8500)
	—	—	—	—
Trailering Special Package	Z82	Z82	Z82	Z82
Minimum Tire Size	Std.	Std.	Std.	Std.
Carrier, Spare Wheel Side Mounted	—	—	—	—
Cooler, Engine Oil	KC4	KC4	KC4	KC4
Cooler, Transmission Oil	V02 ³	V02 ³	V02 ³	V02 ³
Cooling, Heavy-Duty	—	—	Std.	Std.
Mirrors, Camper Type	DF2	DF2	DF2	DF2
Stabilizer Bar, Front, Heavy-Duty	Std.	Std.	Std.	Std.

¹If you order more than the minimum required equipment or carry more than 2 passengers, the additional weight must be subtracted from the maximum trailer weight.

²Manual transmission, RPO MM4, may be used on any 3500 model (heavy-duty radiator, RPO V01, required.)

³Included in Trailering Special Package Z82.

NOTE: Model and driveline combinations must be verified by your local dealer for correct emissions equipment.

NR—Not Required.

4-WHEEL DRIVE DIESEL-POWERED FULL-SIZE PICKUPS

Trailer Classification	Light			Medium			Heavy			
	Gross Trailer Weight (lbs.) up to ¹	2000			4000			6000	6500	8000
Maximum Tongue Load (lbs.)	200			400			750	750	950	900
Series	K1500	K2500	K3500	K1500	K2500	K3500	K1500	K2500	K2500/C6P	K3500
Engine										
6.2L (379) V8 Diesel	LH6	LH6	LL4	LH6	LH6	LL4	LH6	LH6	LL4	LL4
Transmission, Automatic (4 Speed w/Overdrive)	MX0	MX0	MX0	MX0	MX0	MX0	MX0	MX0	MX0	MX0
Minimum Axle Ratio (to 1) (Gross Trailer Weight [lbs.])	3.42	3.42	4.10	3.42	3.42	4.10	3.42	3.73	4.10	4.10
	—	—	—	—	—	—	3.73 (6000)	4.10 (6500)	4.56 (8000)	4.56 (7500)
Trailer Special Package	—	—	—	Z82	Z82	Z82	Z82	Z82	Z82	Z82
Bumper, Rear Step Type ²	V43/VB3	V43/VB3	V43/VB3	—	—	—	—	—	—	—
Cooler, Engine Oil	Std.	Std.	Std.	Std.	Std.	Std.	Std.	Std.	Std.	Std.
Cooler, Transmission Oil	NR	NR	NR	V02 ²	V02 ²	V02 ²	V02 ²	V02 ²	V02 ²	V02 ²
Cooling, Heavy-Duty	Std.	Std.	Std.	Std.	Std.	Std.	Std.	Std.	Std.	Std.
Mirrors, Camper Type	NR	NR	NR	DF2	DF2	DF2	DF2	DF2	DF2	DF2
Electronic Speed Control/ Comfortilt Steering	NR	NR	NR	ZQ3	ZQ3	ZQ3	ZQ3	ZQ3	ZQ3	ZQ3

¹ If you order more than the minimum required equipment or carry more than 2 passengers, the additional weight must be subtracted from the maximum trailer weight.

² Included in Trailering Special Package, RPO Z82.

NOTE: Model and driveline combinations must be verified by your local dealer for correct emissions equipment.

NR—Not Required.

2-WHEEL DRIVE AND 4-WHEEL DRIVE GASOLINE-POWERED FULL-SIZE PICKUPS FIFTH WHEEL WITH KINGPIN-TYPE HITCH

Trailer Classification	Heavy		Heavy		Heavy		Heavy	
	Gross Trailer Weight (lbs.) up to ¹	8000	9000	10,000	14,000	7500	8500	9500
Series	C2500		C2500/C6P	C3500	K2500	K2500/C6P	K3500	
Minimum Engine								
5.0L (305) V8 EFI	L03	—	—	—	L03	—	—	—
5.7L (350) V8 EFI	—	L05	L05	L05	—	L05	L05	L05
7.4L (454) V8 EFI	—	—	L19	L19	—	L19	—	L19
Maximum GVWR (lbs.)	7200	7200	8600	10,000	7200	7200	8600	10,000
Transmission, Automatic ² (4 Speed w/Overdrive)	MX0	MX0	MX0	MX0	MX0	MX0	MX0	MX0
Minimum Axle Ratio (to 1) (Gross Trailer Weight [lbs.])	3.73 (7000)	3.42 (6500)	3.73 (7000)	3.42 (8500)	3.42 (5500)	3.42 (6000)	3.73 (6500)	3.42 (8000)
	4.10 (8000)	3.73 (7500)	4.10 (8500)	3.73 (9500)	3.73 (6500)	3.73 (7000)	4.10 (8000)	3.73 (9000)
	—	4.10 (9000)	4.56 (10,000)	4.10 (11,000)	4.10 (7500)	4.10 (8500)	4.56 (9500)	4.10 (10,500)
	—	—	—	4.56 (14,000)	—	—	—	4.56 (13,500)
Cooler, Engine Oil	KC4	KC4	KC4	KC4	KC4	KC4	KC4	KC4
Cooler, Transmission Oil	V02	V02	V02	V02	V02	V02	V02	V02
Cooling, Heavy-Duty	NR	NR	NR	NR	NR	NR	NR	NR
Mirrors, Camper Type	DF2	DF2	DF2	DF2	DF2	DF2	DF2	DF2
Electronic Speed Control/ Comfortilt Steering	ZQ3	ZQ3	ZQ3	ZQ3	ZQ3	ZQ3	ZQ3	ZQ3

¹ If you order more than the minimum required equipment or carry more than 2 passengers, the additional weight must be subtracted from the maximum trailer weight.

² Manual transmission, RPO MM4, may be used on any 3500 model (heavy-duty radiator, RPO V01, required).

NOTE: Model and driveline combinations must be verified by your local dealer for correct emissions equipment.

NR—Not Required.

K PICKUP

CONVENTIONAL WO-TONE

(ZY2)

Convention two-tone (ZY2) paint colors are available on all models. Color code 1 is applied to the areas above the lower styling crease line (including the cab roof). Color code 2 is applied to the areas below. Outlined block "Chevrolet" decal lettering is applied to the tailgate. (A bright trim plate with lettering is applied on Fleetside models when the Silverado trim is ordered). The only available Color Code 1/Color Code 2 exterior paint combinations are those displayed in the chart below. Recommended interior trim colors are indicated by the symbol ●. For more information, refer to Seats and Interior Trim pages as well as the Truck Order Guide.

Color Code 1

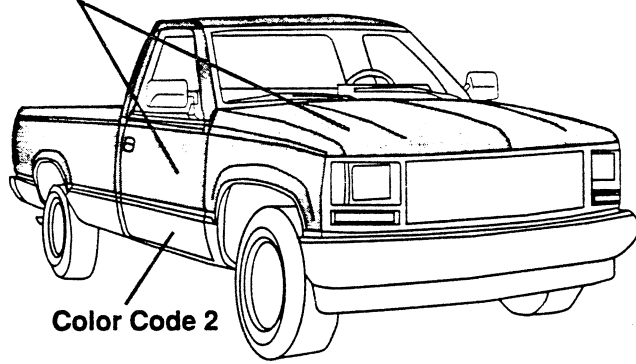

Color Code 2

KEY: ●—Recommended ●—Not Available on C/K Extended Cab

Bold type —Not Available on K3500 Models or K2500 Models w/C6P

EXTERIOR COLORS			STRIPE COLORS		INTERIOR COLORS		
COLOR CODE 1	COLOR CODE 2	w/D 85	Beige	Blue	Garnet	Gray	Saddle
22 Brilliant Blue Metallic	50 Summit White	Lt. Blue		●			
	96 Quicksilver Metallic	Silver		●			
	97 Slate Metallic	Lt. Blue		●			
27 Smoke Blue Metallic	30 Catalina Blue Metallic	Lt. Blue		●			
	41 Onyx Black	Lt. Blue		●			
	41 Onyx Black	Silver				●	
	50 Summit White	Silver				●	
30 Catalina Blue Metallic	50 Summit White	Lt. Blue		●			
	27 Smoke Blue Metallic	Lt. Blue		●			
	50 Summit White	Lt. Blue		●			
41 Onyx Black	96 Quicksilver Metallic	Silver		●			
	50 Summit White	Silver				●	
	58 Sandstone Metallic	Lt. Beige	●				
	70 Flame Red	Vermillion			●	●	
	96 Quicksilver Metallic	Silver				●	
	97 Slate Metallic	Vermillion			●		
50 Summit White	97 Slate Metallic	Silver				●	
	22 Brilliant Blue Metallic	Lt. Blue		●			
	27 Smoke Blue Metallic	Lt. Blue		●			
	30 Catalina Blue Metallic	Lt. Blue		●			
	41 Onyx Black	Gold					●
	41 Onyx Black	Silver				●	
	41 Onyx Black	Vermillion			●		
	70 Flame Red	Vermillion			●		
	94 Crimson Red Metallic	Vermillion			●		
	97 Slate Metallic	Vermillion			●		
58 Sandstone	97 Slate Metallic	Silver				●	
	41 Onyx Black	Dark Brown	●				
	94 Crimson Red Metallic	Vermillion	●				
70 Flame Red	97 Slate Metallic	Vermillion	●				
	41 Onyx Black	Vermillion			●		
	41 Onyx Black	Silver				●	
	50 Summit White	Vermillion			●		
	50 Summit White	Silver				●	
	96 Quicksilver Metallic	Silver			●	●	
94 Crimson Red Metallic	97 Slate Metallic	Vermillion			●		
	97 Slate Metallic	Silver			●		
	41 Onyx Black	Silver				●	
	41 Onyx Black	Vermillion			●		
	50 Summit White	Vermillion			●		
96 Quicksilver	58 Sandstone Metallic	Lt. Beige	●		●		
	96 Quicksilver Metallic	Silver			●	●	
	22 Brilliant Blue Metallic	Lt. Blue		●			
	30 Catalina Blue Metallic	Lt. Blue		●		●	
97 Slate Metallic	41 Onyx Black	Vermillion			●	●	
	41 Onyx Black	Vermillion			●	●	
	70 Flame Red	Vermillion			●	●	
	94 Crimson Red Metallic	Vermillion			●	●	
	97 Slate Metallic	Vermillion			●	●	
	97 Slate Metallic	Vermillion			●	●	
97 Slate Metallic	50 Summit White	Vermillion			●		
	50 Summit White	Silver				●	
	58 Sandstone Metallic	Vermillion		●			
	70 Flame Red	Vermillion			●		
	70 Flame Red	Silver				●	
	96 Quicksilver Metallic	Vermillion			●		
	96 Quicksilver Metallic	Silver				●	
	96 Quicksilver Metallic	Silver				●	
	96 Quicksilver Metallic	Silver				●	
	96 Quicksilver Metallic	Silver				●	

SOLID COLOR

(ZY1)

WT 1500 WORK TRUCK

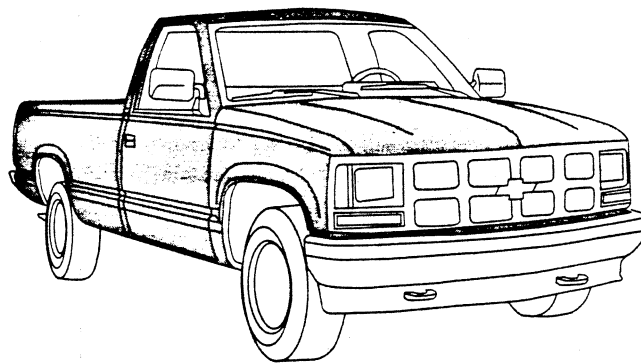

Solid color paint (ZY1) is standard on the WT 1500 Work Truck. All Painted areas of the cab, front end sheet metal, and box are the same color. The only available Color Code 1/Color Code 2 exterior paint combinations are those displayed in the chart below. Recommended interior trim colors are indicated by the symbol ●. For more information, refer to Seats and Interior Trim pages as well as the Truck Order Guide.

KEY: ● — Recommended

EXTERIOR COLORS		STRIPE COLORS	INTERIOR COLORS				
COLOR CODE 1	COLOR CODE 2		Beige	Blue	Garnet	Gray	Saddle
27 Smoke Blue Met.	27 Smoke Blue Metallic	—		●		●	
50 Summit White	50 Summit White	—	●	●	●	●	●
70 Flame Red Met.	70 Flame Red Metallic	—			●	●	●
96 Quicksilver Met.	96 Quicksilver Metallic	—		●	●	●	

DELUXE TWO-TONE

(ZY4)

Deluxe two-tone (ZY4) paint colors are available on Fleetside Pickup models and include the beltline decal described in Special two-tone. The cab roof, hood and pickup box above the beltline decal, as well as the area below the lower styling crease line are painted Color Code 1. The areas between the decal and the lower crease line are painted Color Code 2. Outlined block "Chevrolet" decal lettering is applied to the tailgate. (A bright trim plate with lettering is applied on Fleetside models when the Silverado trim is ordered). The only available Color Code 1/Color Code 2 exterior paint combinations are those displayed in the chart below. Recommended interior trim colors are indicated by the symbol ●. For more information, refer to Seats and Interior Trim pages as well as the Truck Order Guide.

Color Code 1

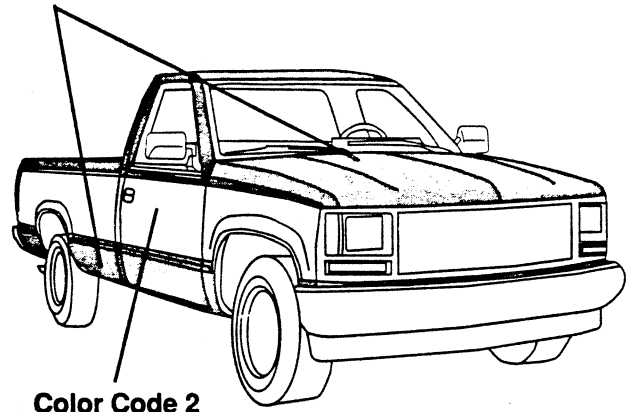

Color Code 2

KEY: ●—Recommended ●—Not Available on C/K Extended Cab **Bold type** —Not Available on K3500 Models or K2500 Models w/C6P

EXTERIOR COLORS		STRIPE COLORS	INTERIOR COLORS			
COLOR CODE 1	COLOR CODE 2		Beige	Blue	Garnet	Gray
22 Brilliant Blue Met.	50 Summit White	Lt. Blue/Dk. Blue		●		
	96 Quicksilver Metallic	Lt. Blue/Slate		●		
	97 Slate Metallic	Lt. Blue/Slate		●		
27 Smoke Blue Met.	30 Catalina Blue	Lt. Blue/Dk. Blue		●		
	41 Onyx Black	Lt. Blue/Dk. Blue		●		
	41 Onyx Black	Dk. Blue/Slate				●
30 Catalina Blue Met.	50 Summit White	Lt. Blue/Slate		●		●
	27 Smoke Blue Metallic	Lt. Blue/Dk. Blue		●		
	50 Summit White	Lt. Blue/Dk. Blue		●		
41 Onyx Black	96 Quicksilver Metallic	Lt. Blue/Dk. Blue		●		●
	50 Summit White	Vermillion/Silver				●
	58 Sandstone Metallic	Gold/Black	●			
50 Summit White	70 Flame Red	Vermillion/Garnet			●	
	70 Flame Red	Vermillion/Silver				●
	94 Crimson Red Metallic	Vermillion/Garnet			●	
	96 Quicksilver Metallic	Vermillion/Silver			●	
	97 Slate Metallic	Vermillion/Silver			●	
	97 Slate Metallic	Vermillion/Silver			●	
58 Sandstone Metallic	41 Onyx Black	Dk. Brown/Black	●			
	94 Crimson Red Metallic	Black/Lt. Sandstone	●			
	97 Slate Metallic	Bt. Orange/Lt. Sandstone	●			
70 Flame Red	41 Onyx Black	Vermillion/Garnet			●	
	41 Onyx Black	Vermillion/Silver				●
	50 Summit White	Vermillion/Garnet			●	
	50 Summit White	Vermillion/Silver				●
	96 Quicksilver Metallic	Vermillion/Silver			●	
	97 Slate Metallic	Vermillion/Garnet			●	
94 Crimson Red Met.	97 Slate Metallic	Vermillion/Silver			●	
	41 Onyx Black	Gold/Black			●	
	50 Summit White	Vermillion/Garnet			●	
	58 Sandstone Metallic	Vermillion/Garnet			●	
	96 Quicksilver Metallic	Vermillion/Garnet			●	
96 Quicksilver Met.	96 Quicksilver Metallic	Vermillion/Silver				●
	22 Brilliant Blue Metallic	Lt. Blue/Slate		●		
	30 Catalina Blue Metallic	Lt. Blue/Dk. Blue		●		
	41 Onyx Black	Vermillion/Garnet			●	
	41 Onyx Black	Vermillion/Silver				●
	70 Flame Red	Vermillion/Garnet			●	
	70 Flame Red	Vermillion/Silver				●
	94 Crimson Red Metallic	Vermillion/Garnet			●	
94 Crimson Red Metallic	Vermillion/Silver				●	
97 Slate Metallic	97 Slate Metallic	Vermillion/Silver			●	
	41 Onyx Black	Vermillion/Silver			●	
	58 Sandstone Metallic	Bt. Orange/Lt. Sandstone	●			
	58 Summit White	Vermillion/Silver			●	
97 Slate Metallic	70 Flame Red	Vermillion/Silver			●	
	96 Quicksilver Metallic	Vermillion/Silver			●	

SPECIAL TWO-TONE (ZY3)

Special two-tone (ZY3) paint colors are available only on Fleetside pickup models and include a multi-stripe decal applied over the paint break at the beltline. Color Code 1 is applied to the areas above the decal (including the cab roof). Color Code 2 is applied to the areas below. Outlined block "Chevrolet" decal lettering is applied to the tailgate. (A bright trim plate with lettering is applied on Fleetside models when the Silverado trim is ordered.) The only available Color Code 1/Color Code 2 exterior paint combinations are those displayed in the chart below. Recommended interior trim colors are indicated by the symbol ●. For more information, refer to Seats and Interior Trim pages as well as the Truck Order Guide.

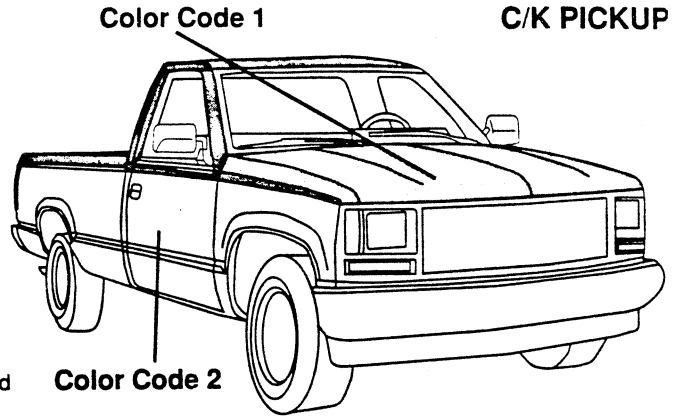

KEY: ●—Recommended ●—Not Available on C/K Extended Cab **Bold type**—Not Available on K3500 Models or K2500 Models w/C6P.

EXTERIOR COLORS		STRIPE COLORS	INTERIOR COLORS			
COLOR CODE 1	COLOR CODE 2		Beige	Blue	Garnet	Gray
22 Brilliant Blue Metallic	50 Summit White	Lt. Blue/Dk. Blue		●		
	96 Quicksilver Metallic	Lt. Blue/Slate		●		
	97 Slate Metallic	Lt. Blue/Slate		●		
27 Smoke Blue Metallic	30 Catalina Blue	Lt. Blue/Dk. Blue		●		
	41 Onyx Black	Lt. Blue/Dk. Blue		●		
	41 Onyx Black	Dk. Blue/Slate		●		●
	50 Summit White	Lt. Blue/Slate		●		●
30 Catalina Blue Metallic	27 Smoke Blue Metallic	Lt. Blue/Dk. Blue		●		
	50 Summit White	Lt. Blue/Dk. Blue		●		
	96 Quicksilver Metallic	Lt. Blue/Dk. Blue		●		●
41 Onyx Black	50 Summit White	Vermillion/Silver				●
	58 Sandstone Metallic	Gold/Black	●			
	70 Flame Red	Vermillion/Garnet			●	
	70 Flame Red	Vermillion/Silver				●
	94 Crimson Red Metallic	Vermillion/Garnet			●	
	96 Quicksilver Metallic	Vermillion/Silver				●
50 Summit White	97 Slate Metallic	Vermillion/Silver			●	●
	22 Brilliant Blue Metallic	Lt. Blue/Dk. Blue		●		
	27 Smoke Blue Metallic	Lt. Blue/Dk. Blue		●		
	30 Catalina Blue Metallic	Lt. Blue/Dk. Blue		●		
	41 Onyx Black	Vermillion/Garnet			●	
	41 Onyx Black	Vermillion/Silver				●
	70 Flame Red	Vermillion/Garnet			●	
	94 Crimson Red Metallic	Vermillion/Garnet			●	
58 Sandstone Metallic	97 Slate Metallic	Vermillion/Silver			●	●
	41 Onyx Black	Dk. Brown/Black	●			
	94 Crimson Red Metallic	Black/Lt. Sandstone	●			
70 Flame Red	97 Slate Metallic	Bt. Orange/Lt. Sandstone	●			
	41 Onyx Black	Vermillion/Garnet			●	
	41 Onyx Black	Vermillion/Silver				●
	50 Summit White	Vermillion/Garnet			●	
	50 Summit White	Vermillion/Silver				●
	96 Quicksilver Met.	Vermillion/Silver			●	●
	97 Slate Metallic	Vermillion/Garnet			●	
94 Crimson Red Metallic	97 Slate Metallic	Vermillion/Silver			●	●
	41 Onyx Black	Gold/Black			●	
	50 Summit White	Vermillion/Garnet			●	
	58 Sandstone Metallic	Vermillion/Garnet			●	
	96 Quicksilver Metallic	Vermillion/Garnet			●	
	96 Quicksilver Metallic	Vermillion/Silver				●
96 Quicksilver	22 Brilliant Blue Metallic	Lt. Blue/Slate		●		
	30 Catalina Blue Metallic	Lt. Blue/Dk. Blue		●		●
	41 Onyx Black	Vermillion/Garnet			●	
	41 Onyx Black	Vermillion/Silver				●
	70 Flame Red	Vermillion/Garnet			●	
	70 Flame Red	Vermillion/Silver				●
	94 Crimson Red Metallic	Vermillion/Garnet			●	
	94 Crimson Red Metallic	Vermillion/Silver				●
	97 Slate Metallic	Vermillion/Silver			●	●
97 Slate Metallic	41 Onyx Black	Vermillion/Silver				●
	58 Sandstone Metallic	Bt. Orange/Lt. Sandstone	●			
	58 Summit White	Vermillion/Silver			●	●
	70 Flame Red	Vermillion/Silver			●	●
	96 Quicksilver Metallic	Vermillion/Silver			●	●

HOW TO USE GCWRs TO DETERMINE POWERTRAIN AND REAR AXLE RATIO FOR TRAILERING

Perhaps you prefer to use Gross Combination Weight Ratings (GCWRs) to determine the engine, transmission and rear axle ratio you will require to tow a trailer with your truck. The chart below allows you to do just that. It shows you the maximum allowable GCWR based on all the available truck engines and rear

axle ratios with automatic or manual transmissions. **The GCWR includes the total loaded weight of both the truck and trailer.** Any available engine may be used for trailering if the GCWR shown is not exceeded. The trailer weight can be increased by 25% if the vehicle speed will not exceed 25 mph.

GROSS COMBINATION WEIGHT RATING (GCWR) By Engine & Axle Ratio For Recreational Applications																				
With Automatic Transmission																				
GCWR (lb.)	6000	6500	7000	7500	8000	8500	9000	9500	10,000	10,500	11,000	11,500	12,000	12,500	13,500	14,000	14,500	15,000	16,000	19,000
Engines	Rear Axle Ratios																			
4.3L (262) V6 Gas				2.73		3.08	3.23	3.42	3.73	4.10/ 4.11	4.56									
5.0L (305) V8 Gas					2.73			3.08		3.42		3.73		4.10						
5.7L (350) V8 Gas							2.73		3.08	3.23	3.42		3.73		4.10			4.56		
6.2L (379) V8 Diesel								3.08	3.23	3.42		3.73		4.10		4.56	5.13			
7.4L (454) V8 Gas															3.42		3.73		4.10	4.56
With Manual Transmission																				
GCWR (lb.)	5000	5500	6000	6500	7000	8000	8500	9000	9500	10,000	11,000	12,000	13,500	14,500	15,000	16,000	19,000			
Engines	Rear Axle Ratios																			
4.3L (262) V6 Gas				2.73	3.08	3.42	3.73													
5.0L (305) V8 Gas						3.08	3.42		3.73											
5.7L (350) V8 Gas											3.08	3.42	3.73	4.10		4.56				
6.2L (379) V8 Diesel						3.08	3.42		3.73		4.10	4.56								
7.4L (454) V8 Gas														3.42	3.73		4.10	4.56		

Note: Model and driveline combinations must be verified by your local dealer for correct emissions equipment.

GENERAL TRAILERING INFORMATION

AVAILABLE TRAILERING EQUIPMENT

Chevrolet offers a wide selection of available options for trailering and a few of them are described here.

LIGHT-DUTY TRAILER HITCH

For hauling trailers up to 2000-lbs. with a maximum tongue load of 200-lbs. A 1 7/8"-diameter ball is included. (Dealer-installed accessory. See chart for part numbers.)

HITCH BALLS

1 7/8"-diameter ball is standard with light-duty hitches. It is also available as an accessory: Part No. 981148. A 2"-diameter ball is also available for hitches as Part No. 980670.

LOAD-DISTRIBUTING PLATFORM

Required when towing trailers over 2000-lbs. Installs quickly and easily. (Dealer-installed accessory. See chart for part numbers.)

WIRING HARNESSES

5-wire used with trailers over 2000-lbs. gross weight and 7-wire for larger trailers. Harnesses tie into vehicle's electrical system to give your trailer lights, plus electric brakes or battery charging.

TRUCK WIRING CODE

The following color code for trucks should be used when installing trailer wiring harnesses.

- **Blue.** Used for electric trailer brakes or auxiliary wiring.
- **Red.** Used for battery charging. Connects to starter solenoid. (7-wire harness only).
- **Light Green.** Backup lights (7-wire harness only).
- **Brown.** Taillight and running lights.
- **Yellow.** Left stop and turn signal.
- **Dark Green.** Right stop and turn signal.
- **White.** Ground.

MIRRORS

Trucks used as tow vehicles will require outside mirrors with extensions that exceed the width of the trailer to be towed. Optional mirrors with larger mounting brackets are available with all truck models.

COOLERS AND COOLING

Trailering creates higher-than-normal temperatures in coolant, engine and transmission oil. To help control these temperatures, consider the following separate options.

RPO V02. This is an extra-capacity heavy-duty automatic transmission oil cooler option. (Included in RPO Z82 Special Trailering Package.)

RPO KC4. This optional engine oil cooler circulates oil through a separate cooler mounted ahead of the radiator. (Included in RPO Z82 Special Trailering Package.)

DEALER-INSTALLED TRAILER HITCHES

	Light Up to 2000-Lbs. 200-Lb. Tongue Load	Light/Medium Up to 4000-Lbs. 400-Lb. Tongue Load	Heavy Up to 6000-Lbs. 750-Lb. Tongue Load	Heavy Up to 7000-Lbs. 850-Lb. Tongue Load
Type of Hitch	Deadweight ¹	Rear Step Bumper ²	Weight-Distrib. Platform	Weight-Distrib. Platform
C/K Pickup (Long wheelbase only)		999862-Painted 999863-Chromed	—	999772 ²

¹ Deadweight hitch includes 1 7/8" ball. ² Requires a rear bumper. Not available with underframe space tire carrier.

³ 1 7/8" ball for step-type bumper—Part No. 998392. 2" ball for step-bumper—Part No. 980670

NOTE: If the vehicle is equipped with a step bumper, the "V" shaped foot on the trailer tongue could dent the step bumper in a sharp turn. Before towing a trailer with a vehicle equipped with a step bumper, check the distance from the trailer foot front edge to the center of the couple ball socket. If this dimension is less than 12 inches, remove the foot on the trailer tongue or possible damage to the step bumper could occur.

2-WHEEL DRIVE AND 4-WHEEL DRIVE GASOLINE AND DIESEL POWERED FULL SIZE PICKUPS—5TH WHEEL TRAILERING

Trailer Classification	C/K REGULAR CAB		C/K REGULAR CAB	
	Heavy		Heavy	
Gross Trailer Weight (lbs.) up to ¹	14,000	13,500	8000	7500
Series	C3500	K3500	C3500	K3500
Minimum Engine				
5.7L (350) V8 EFI	L05	L05	—	—
7.4L (454) V8 EFI	L19	L19	—	—
6.2L (379) V8 Diesel	—	—	LL4	LL4
Maximum GVWR (lbs)	10,000	10,000	10,000	10,000
Transmission, Automatic ² (4 Speed w/Overdrive)	MX0	MX0	MX0	MX0
Minimum Axle Ratio (to 1) (Gross Trailer Weight [lbs.]) w/5.7L V8 Engine	4.10 (8500)	4.10 (8000)	—	—
	4.56 (10,000)	4.56 (10,000)	—	—
w/7.4L V8 Engine	4.10 (11,000)	4.10 (10,500)	—	—
	4.56² (14,000)	4.56² (13,500)	—	—
w/6.2L V8 Diesel	—	—	4.10 (8000)	4.10 (7500)
Minimum Tire Size	Std.	Std.	Std.	Std.
Cooler, Engine Oil	KC4	KC4	Std.	Std.
Cooler, Transmission Oil ⁴	V02	V02	V02	V02
Cooling, Heavy-Duty	V01	V01	Std.	Std.
Mirrors, Camper Type	DF2	DF2	DF2	DF2
Stabilizer Bar, Front, Heavy-Duty	Std.	Std.	Std.	Std.

¹ If you order more than the minimum required equipment or carry more than 2 passengers, the additional weight must be subtracted from the maximum trailer weight.

² Manual transmission can also be specified.

NOTE 1: Maximum Gross Combination Weight (GCWR) for fifth-wheel commercial trailering is 18,000-lbs. with gasoline engines and 15,000-lbs. with diesel engines.

NOTE 2: Model and driveline combinations must be verified by your local dealer for correct emissions equipment.