

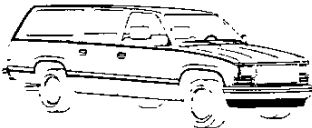
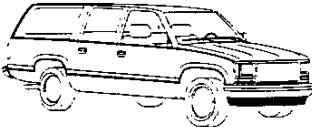

CONTENTS

	<u>Page</u>
MODELS	2
CHEYENNE TRIM	4
SILVERADO (YE9) TRIM	5
POWERTRAINS	6
STANDARD SUSPENSION	8
OPTIONAL SUSPENSION	9
WHEELS AND TIRES	10
FRAME/STEERING/BRAKES	11
ELECTRICAL	12
COOLING	14
DIMENSIONS	15
OPTIONS	17
COLOR COMBINATIONS	19
EXTERIOR COLORS	B
INTERIOR TRIM	C
SEATS	D
TRAILERING	E

TWO-WHEEL DRIVE MODELS

C1500 SUBURBAN 	MODEL NUMBER	WB (IN.)	GVWR (LBS.)	MAX' PAYLOAD (LBS.)	PASS. CAP. (STD/OPT)	STD ENGINE/ TRANS	OPT ENGINE/ TRANS	C1500 SUBURBAN The all new C1500 Suburban is the base two-wheel drive Suburban model. It is offered with a powerful of gasoline engine and a wide choice of seating configurations. C2500 SUBURBAN The all new C2500 Suburban offers an 8600-lb. GVWR and expanded powertrain availability when compared to the C1500 Suburban series.
	CC10906	131.5	6800	2099	2/3/5 6/8/9	5.7L V8/A4	—	
C2500 SUBURBAN 	MODEL NUMBER	WB (IN.)	GVWR (LBS.)	MAX' PAYLOAD (LBS.)	PASS. CAP. (STD/OPT)	STD ENGINE/ TRANS	OPT ENGINE/ TRANS	
	CC20906	131.5	8600	3321	2/3/5 6/8/9	5.7L V8/A4	7.4L V8/A4	

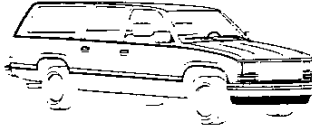
FOUR-WHEEL DRIVE MODELS

K1500 SUBURBAN 	MODEL NUMBER	WB (IN.)	GVWR (LBS.)	MAX' PAYLOAD (LBS.)	PASS. CAP. (STD/OPT)	STD ENGINE/ TRANS	OPT ENGINE/ TRANS	K1500 SUBURBAN The all new K1500 Suburban is the base four-wheel drive Suburban model. It is offered with a gasoline engine with a choice of seating configurations. K2500 SUBURBAN The all new K2500 Suburban offers an 8600-lb. GVWR and a choice of gasoline engines.
	CK10906	131.5	7200	2031	2/3/5 6/8/9	5.7L V8/A4	—	
K2500 SUBURBAN 	MODEL NUMBER	WB (IN.)	GVWR (LBS.)	MAX' PAYLOAD (LBS.)	PASS. CAP. (STD/OPT)	STD ENGINE/ TRANS	OPT ENGINE/ TRANS	
	CK20906	131.5	8600	3065	2/3/5 6/8/9	5.7L V8/A4	7.4L V8/A4	

Based on Curb Weight.

C/K SUBURBAN SEATING

STANDARD: FRONT BENCH SEAT (*)**

A three-passenger vinyl front bench seat with outboard head restraints is standard. It is available in Custom Vinyl for the Cheyenne or Custom Cloth for the Silverado. A fold-down center armrest is included on the Silverado. All other seats are optional.

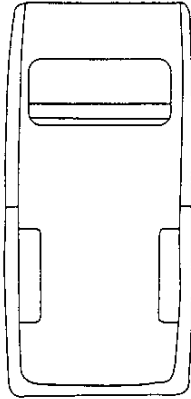

OPTIONAL: 40/60 RECLINING SPLIT FRONT BENCH SEAT (*)—SILVERADO**

This optional 3-passenger bench seat features full width, full depth, a folding/reclining backrest and outboard head restraints. Available in Custom Cloth only.

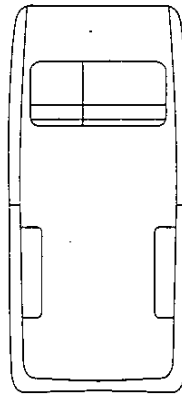

OPTIONAL: RECLINING HIGH-BACK FRONT BUCKLED SEATS (*)—SILVERADO**

These bucket seats include head restraints. This option also includes a center and overhead roof console. Available in Custom Cloth only.

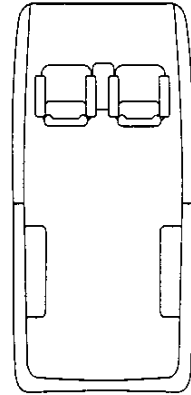

OPTIONAL: 60/40 SPLIT CENTER BENCH SEAT (AT5)

This is an optional full width, full depth 3-passenger bench seat. It is available in Custom Vinyl for Cheyenne and Custom Cloth with folding backrest for Silverado. Both include easy entry feature and are available with all standard and optional front seats.

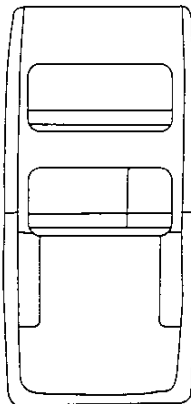

OPTIONAL: REAR BENCH SEAT (AS3)

This is an optional rear seat is a quick-release removable bench seat. It is available in Custom Vinyl for Cheyenne and Custom Cloth for Silverado. **This option includes AT5 60/40 split bench seat.**

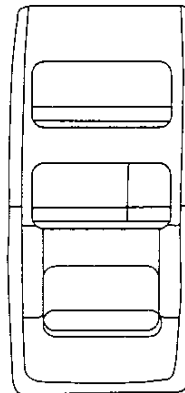

C/K SUBURBAN

CHEYENNE

The Cheyenne trim level is the standard trim level for the C/K Suburban series. It is designed to offer truck buyers a high level of standard features when purchasing a standard level vehicle.

The following features are standard.

POWERTRAIN/CHASSIS

- ALTERNATOR: 100 Amp Delcotron
- BATTERY: 12 volt, negative ground; 630 CCA @ 0 degrees F.
- BRAKES: Power; vacuum Front—disc. Rear—drum. Includes four wheel anti-lock system.
- ENGINE: 5.7-liter V8 EFI. C/K 1500 series produces 210 net hp @ 4000 rpm and 300 lb. ft. of net torque @ 2800 rpm. C/K 2500 series produces 190 net hp @ 4000 rpm and 300 lb.ft. of net torque @ 2400rpm
- EXHAUST: Aluminized single exhaust.
- FRAME: All-welded ladder-type with a channel design and boxed front-end section.
- FUEL TANK: 42-gallon (approx.) capacity.
- REAR AXLE: Hypoid, Semi-Floating on all models.
- SHOCK ABSORBERS: Front and Rear —32 mm piston dia.
- STABILIZER BAR: Front—1.25 inch dia. (standard on two-wheel drive). 1.18 inch dia. (standard on four-wheel drive). Rear — 0.87 inch dia. (all models)
- STEERING: Integral Power. Ratio—On Center/At Lock—16/13:1 on all models except K 2500 series. 16/13.5:1 (K 2500 series).
- SUSPENSION: Front—Independent coil springs. (Independent Torsion Bar on four wheel drive). Rear—Semi-Elliptic 2-Stage multi-leaf springs.
- TRANSMISSION: 4-speed automatic with overdrive and steering column mounted shift lever.

EXTERIOR

- AIRDAM: Black (C/K 10906 Only)
- BUMPERS: Chromed front and rear, with black rub strips. Rear has black step pads.
- COLORS: Choice of ten in solid paint scheme. See Color and Trim Specifications for details.
- GRILLE: Molded plastic painted light argent with dark argent air intake areas.
- HEADLAMPS: Single rectangular halogen.
- HORN: Dual high-note and low-note.
- LIFTGATE: Lift glass/drop gate.
- MIRRORS: RH and LH below-eye-line type painted black. Head size is 6.5" x 9.0".
- MOLDINGS: Black body side and wheel openings with body color drip moldings.
- TIRES: Five (including spare) steel-belted radials (sizes vary with model. See Wheels and Tires for details.)
- TOW HOOKS: Front on all four-wheel drive models.
- WHEELS: Five silver painted steel (15" x 7.0" on C1500 and 16" x 6.5" on K1500 and C/K 2500).
- WHEEL COVERS: Black hub caps.

INTERIOR

- ARMRESTS: RH and LH padded integral with door panels.
- CIGARETTE LIGHTER: Located on instrument panel inside ashtray bin.
- COAT HOOKS: Two RH and two LH coat hooks located above intermediate seat and in cargo area.
- COLORS: Choice of four. Blue, Garnet, Beige, or Gray.
- DOME LAMP: Front and rear ceiling mounted with switch in front RH and LH door jambs.
- DOOR PANELS: Color-keyed molded plastic.
- DOOR SILL PLATES: Color-keyed.
- FLOOR COVERINGS: Two piece black vinyl mats for entire area.
- GAUGES: Include needle speedometer, odometer with trip odometer, fuel level, voltmeter, oil pressure, engine temperature, and additional telltale lights.
- HEADLAMP WARNING BUZZER.
- HEADLINER: Full-length, color-keyed cloth with matching retainer moldings.
- HEATER: Deluxe outside-air type with windshield and side window defoggers.
- INSULATION: On dash panel, on floor panel, under cowl panel and on headliner.
- MAP LIGHT.
- MIRRORS: 10-inch rearview.
- RADIO: Electronically tuned AM radio with two front dash mounted speakers, and fixed mast antenna. (Please refer to the Delco Electronics Brochure in RPO Detail for further information.)
- SEATS: Front 3-passenger bench with outboard head restraints and matching intermediate 3-passenger 60/40 split folding bench on K10906.
- SPARE TIRE/WHEEL: Full size; located on LH rear side. (Optional on C/K 2500 models.)
- SPARE TIRE CARRIER: Located on LH rear side. (C/K1500 series models.)
- STEERING WHEEL: 4-spoke custom steering wheel.
- SUNSHADES: Padded, color-keyed RH and LH.
- TOOLS: Includes mechanical jack and wheel wrench located on LH rear side.
- WINDOWS: Tinted glass on all windows including shade band on upper part of windshield.
- WINDSHIELD WIPERS: Intermittent.

SILVERADO

(YE9)

The Silverado trim level is an optional trim level for the C/K Suburban series. It is designed to offer truck buyers an increased level of comfort and convenience features compared to the standard Cheyenne trim level.

The following features are standard. Bold type denotes equipment in addition to or replacing that of the standard Cheyenne trim level.

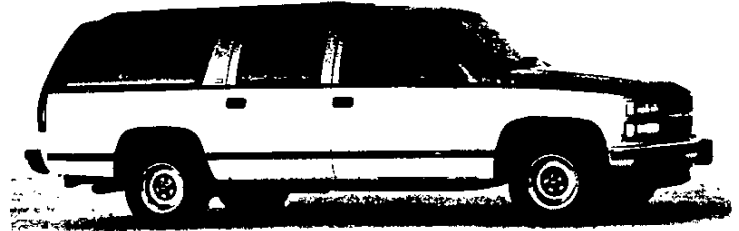

Some equipment shown may be optional or extra cost.

POWERTRAIN/CHASSIS

- ALTERNATOR: 100 Amp Delcotron
- BATTERY: 12 volt, negative ground; 630 CCA @ 0 degrees.
- BRAKES: Power vacuum; Front—disc. Rear—drum. Includes four wheel anti-lock system.
- ENGINE: 5.7-liter V8 EFI. C/K 1500 series produces 210 net hp @ 4000 rpm and 300 lb. ft. of net torque @ 2800 rpm. C/K 2500 series produces 190 net hp @ 4000 rpm and 300 lb. ft. of net torque @ 2400 rpm.
- EXHAUST: Aluminized single exhaust.
- FRAME: All-welded ladder-type with a channel design and boxed front-end section.
- FUEL TANK: 42-gallon (approx.) capacity.
- REAR AXLE: Hypoid, Semi-Floating on all models.
- SHOCK ABSORBERS: Front and Rear—32 mm piston dia.
- STABILIZER BAR: Front—1.25 inch dia. (on two-wheel drive). 1.18 inch dia. (on four-wheel drive). Rear—0.87 inch.
- STEERING: Integral Power. Ratio—On Center/At Lock—16/13:1 on all models except K 2500 series. 16/13.5:1 (K 2500 series).
- SUSPENSION: Front—Independent coil spring. (Independent Torsion Bar on four-wheel drive). Rear—Semi-Elliptic 2-Stage Multi-leaf springs.
- TRANSMISSION: 4-speed automatic with overdrive and steering column mounted shift lever.

EXTERIOR

- AIRDAM: Black (C/K 10906 Only)
- BUMPER: Chromed front and rear with black rub strips and bright trim. Also includes front bumper guards and rear black step pads.
- COLORS: Choice of ten in a solid paint scheme. See Color and Trim Specifications for details.
- GRILLE: Deluxe appearance consisting of dark argent grille with bright trim.
- HEADLAMPS: Dual rectangular halogen.
- HORN: Dual high-note and low-note.
- LAMP: Underhood, reel-type removable.
- LIFTGATE: Lift glass/drop gate.
- MIRRORS: Bright RH and LH below-eye-line type. Head size is 6.5" x 9.0".
- MOLDINGS: Deluxe package includes black body side and rear with bright trim and bright wheel opening with body color drip moldings.
- TIRES: Five (including spare) steel-belted radials. (sizes vary with model. See Wheels and Tires for details.)
- TOW HOOKS: Front on all four-wheel drive models.
- WHEELS: Five silver painted steel (15" x 7.0" on C/K1500 and 16"x6.5" on K1500 and C/K2500 models).
- WHEEL COVERS: Bright metal.

INTERIOR

- ARMRESTS: RH and LH padded integral with door panels.
- CIGARETTE LIGHTER: Included on instrument panel inside ashtray bin.
- COAT HOOKS: Two RH and two LH coat hooks located above intermediate seat and in cargo area.
- COLORS: Choice of four interior. Blue, Garnet, Beige or Gray.
- DOME LAMP: Front and rear ceiling mounted with switches on all doors and rear lift glass. Also includes front and rear map lights.
- DOOR PANELS: Vinyl door trim with cloth inserts and carpet trim. Front also has map pockets and door closing assist straps. Coordinated rear door/tailgate and rear sidewall trim panels are included.
- DOOR SILL PLATES: Color-keyed.
- FLOOR COVERINGS: Consist of color-keyed front compartment carpeting (matching carpeting provided for center and rear seating areas including rear wheelhousing, with available center or center/rear seats).
- FLOOR MATS: Removable, color-keyed front and rear.
- GAUGES: Include needle speedometer, odometer with trip odometer, fuel level, voltmeter, oil pressure, engine temperature, and additional telltale lights.
- GLOVE BOX LIGHT.
- HEADLAMP WARNING BUZZER.
- HEADLINER: Full-length, color-keyed cloth with matching retainer moldings.
- HEATER: Deluxe outside-air type with windshield and side window defoggers.
- INSULATION: On dash panel, on floor panel, under cowl panel and on headliner. Extra thick on body side trim panels and under instrument panel at center.
- INSTRUMENT PANEL: Applique with woodgrain trim.
- MIRRORS: 10-inch rearview.
- POWER DOOR LOCKS.
- RADIO: Electronically-tuned AM radio with one 4"x10" center front dash mounted speaker, and fixed mast antenna (Please refer to the Delco Electronics Brochure in RPO Detail for further information.)
- SEATS: Front 3-passenger bench with outboard head restraints, cloth trim and matching intermediate 3-passenger 60/40 split folding bench.
- SPARE TIRE/WHEEL: Full size; located on LH rear side on C/K 1500 models only. (Optional on C/K 2500 models.)
- SPARE TIRE CARRIER: With color-keyed carpet tire cover on LH rear side. (C/K1500 series models);
- STEERING WHEEL: 4-spoke sport, with simulated leather appearance.
- SUNSHADES: Padded, color-keyed RH and LH with illuminated mirrors.
- TOOLS: Includes mechanical jack and wheel wrench located on LH rear side.
- WINDOWS: Tinted glass on all including shade band on upper part of windshield.
- WINDSHIELD WIPERS: Intermittent.

TRANSMISSION		AUTOMATIC	
MODEL	AUTOMATIC 4-SPEED w/OVERDRIVE 700R4 ¹	AUTOMATIC 4-SPEED w/OVERDRIVE 4L80-E ²	
RPO CODE	MX0	MX0	
GEAR RATIOS			
First	3.06	2.48	
Second	1.63	1.48	
Third	1.00	1.00	
Fourth	0.70	0.75	
Reverse	2.29	2.08	
GEAR TYPE	Planetary	Planetary	
TORQUE CONVERTER			
Element Types	Pump/Stator/Turbine	Pump/Stator/Turbine	
Lock-up Clutch	Automatic	Automatic	
LUBRICANT CAPACITY (pints)			
Dry Fill	19	13.5	
Refill	10	6	

¹C models up to 8600 GVWR.

²All models above 8600 GVWR.

TRANSFER CASE	
MODEL	NEW PROCESS 241
AVAILABILITY	K1500/K2500
RATIOS	1.00:1 2.72:1
Hi Range	
Lo Range	
LEVER POSITIONS	4-Lo (All-wheel Underdrive) N(Neutral) 2-Hi (Rear-wheel Drive) 4-Hi (All-wheel Drive)
LEVER LOCATION	Rear of Transmission at Center of Floor
POWER TAKE-OFF DATA	
Opening Location	—
OIL CAPACITY (pints)	10

KEY: S Standard O Optional — Not Offered

MODEL	ENGINE	TRANSMISSION (MX0) AUTOMATIC 4-SPEED	AXLES			GVWR
			ECONOMY — POWER			
			3.42	3.73	4.10	
C1500 SUBURBAN 4X2 C10906	5.7 V8 (L05)	S	—	O	—	6800
C2500 SUBURBAN 4X2 C20906	5.7L V8 (L05)	S	S ¹	—	O	8600
	7.4L V8 (L19)	S	S ¹	—	O ¹	8600
K1500 SUBURBAN 4X4 K10906	5.7L V8 (L05)	S	S	O	—	7200
K2500 SUBURBAN 4X4 K20906	5.7L V8 (L05)	S	S	—	O	8600
	7.4L V8 (L19)	S	S ¹	—	O ¹	8600

¹Requires KC4 and VO2 Cooling.

AXLES	REAR				FRONT—FOUR-WHEEL DRIVE				
MAKE AND CAPACITY (lbs.)	GM 4000 ³		GM 6000/6000 ^{1,3} Semi-Floating		GM 3925 ³ Full-Floating		Dana 4250 ³ Full-Floating		
PINION & RING GEAR	Hypoid				Hypoid				
Type	Hypoid				Hypoid				
Ratio	3.08	3.42	3.73	3.42	4.10	3.42	3.73	3.42	4.10
Pinion Teeth	13	12	11	12	10	12	11	12	10
Ring Gear Teeth	40	41	41	41	41	41	41	41	41
Ring Gear Dia. (in.)	8.5	8.5	8.5	9.5/10.5 ²	9.5/10.5 ²	8.50	8.50	9.5/10.5 ²	9.5/10.5 ²
DIFFERENTIAL	2-Pinion Tapered Roller		2-Pinion/4-Pinion Tapered Roller		2-Pinion Tapered Roller		2-Pinion Tapered Roller		
Type	2-Pinion Tapered Roller		2-Pinion/4-Pinion Tapered Roller		2-Pinion Tapered Roller		2-Pinion Tapered Roller		
BEARINGS, Type	2-Pinion Tapered Roller		2-Pinion/4-Pinion Tapered Roller		2-Pinion Tapered Roller		2-Pinion Tapered Roller		
AXLE SHAFTS	Semi-Floating Integral Shaft and Drive Flange		Semi-Floating/ Full-Floating Integral Shaft and Drive Flange		Full-Floating		Full-Floating		
Type	Semi-Floating Integral Shaft and Drive Flange		Semi-Floating/ Full-Floating Integral Shaft and Drive Flange		Full-Floating		Full-Floating		
Min. Diameter (in.)	—		—/1.34		—		—		
HOUSING @ SPRING SEAT	3.0 x .25		3.34 x .261/ 3.38 x 2.0		—		—		
Section Diameter and Thickness (in.)	3.0 x .25		3.34 x .261/ 3.38 x 2.0		—		—		
LUBRICANT CAPACITY (pints)	—		—		4.5		4.5		

¹Full-floating with 7.4L(L19) Engine. ²10.5 w/7.4L(L19) Engine.

³Refer to Standard and Optional Suspension, pages 8 and 9, for specific model availability.

HORSEPOWER AND TORQUE RATINGS			
ENGINE	5.7L V8		7.4L V8
RPO CODE	L05		L19
RESTRICTIONS	UP TO 8500 Lbs. GVWR C/K1500 MODELS	ABOVE 8500 Lbs. GVWR C/K2500 MODELS	—
CHART REFERENCE CODE	A	B	C
SAE NET HORSEPOWER Horsepower @ RPM	210 @ 4000	190 @ 4000	230 @ 3600
SAE NET TORQUE Lb. Ft. @ RPM	300 @ 2800	300 @ 2400	385 @ 1600
FUEL SYSTEM	EFI	EFI	EFI
CLUTCH SIZE (in.)	12	12	—
STD. BATTERY Cold Cranking Amps @ 0°F	630	630	630

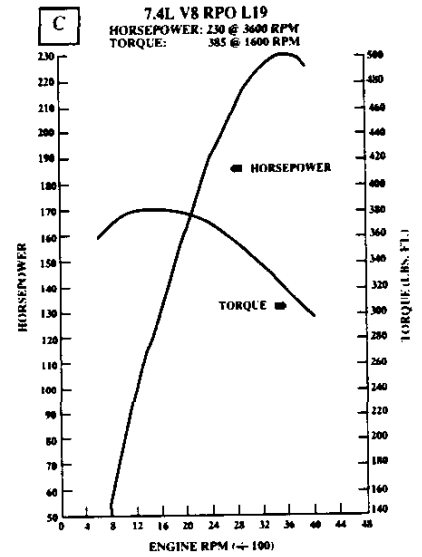
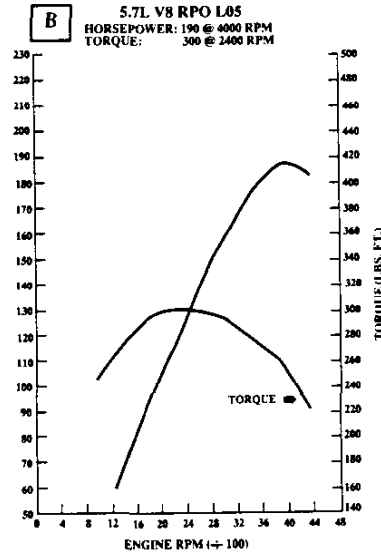
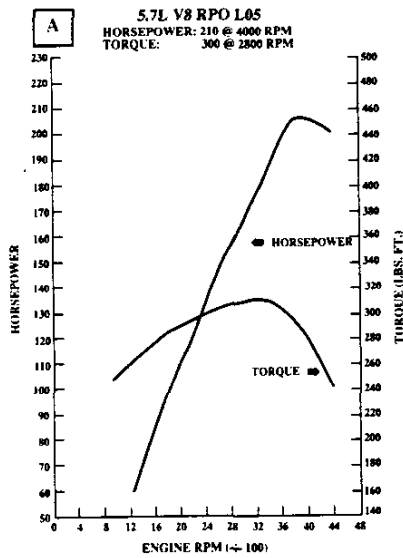

		TWO-WHEEL DRIVE MODELS		FOUR-WHEEL DRIVE MODELS	
MODEL		C1500 SUBURBAN 4X2	C2500 SUBURBAN 4X2	K1500 SUBURBAN 4X4	K2500 SUBURBAN 4X4
MODEL NUMBER		CC10906	CC20906	CK10906	CK20906
		GAS	GAS	GAS	GAS
STANDARD SUSPENSION					
PAYLOAD (Max. lbs.) ¹		2099	3321	2031	3065
GVWR (lbs.)		6800	8600	7200	8600
GAWR (lbs.)	Front	3150	3600	3600	3750
	Rear	3968	6000	4000	6000
FRONT SUSPENSION					
Type		Independent Coil Spring	Independent Coil Spring	Independent Torsion Bar	Independent Torsion Bar
Standard Spring Capacity (Total lbs.)		3150	3600	3600	3750
Front Shock Absorbers Piston Diameter (mm)		32	32	32	32
Front Stabilizer Bar Diameter (in.)		1.25	1.25	1.18	1.18
REAR SUSPENSION					
Type		Semi-Elliptic 2-Stage Multi-Leaf	Semi-Elliptic 2-Stage Multi-Leaf	Semi-Elliptic 2-Stage Multi-Leaf	Semi-Elliptic 2-Stage Multi-Leaf
Standard Spring Capacity (Total lbs.)		4000	6000	4000	6000
Leaves Per Spring		6	8	5	8
Leaf Tot. Thickness (in.)		2.19	2.93	2.26	2.93
Rear Shock Absorbers Piston Diameter (mm)		32	32	32	32
Rear Stabilizer Bar Diameter (in.)		.87	.87	.87	.87
FRONT AXLE					
Type		—	—	—	—
Make		—	—	—	—
Maximum Capacity (lbs.)		3400	3800	3925	4250
Standard Hub Locks		—	—	—	—
Pinion/Ring Gear Type		Hypoid	Hypoid	Hypoid	Hypoid
REAR AXLE					
Type		Semi-Floating	Semi-Floating ²	Semi-Floating	Semi-Floating
Make		GM	GM	GM	GM
Maximum Capacity (lbs.)		4000	6000	4000	6000
Pinion/Ring Gear Type		Hypoid	Hypoid	Hypoid	Hypoid
STANDARD TIRES					
		Tubeless SBR P235/75R15XL	Tubeless SBR LT245/75R16E	Tubeless SBR LT225/75R16D	Tubeless SBR LT245/75R16C
Capacity (lbs.)					
Front/Rear		1843	3042	2335	3042
Inflation (psi) maximum		32/35	80	65	80
Revolutions per mile @ 45 mph		722	678	706	678
WHEELS					
Size (in.) Front/Rear		15.0 x 7.0	16.0 x 6.5	16.0 x 6.5	16.0 x 6.5
Capacity (lbs.)		1984	3042	2400	3042
Bolt Holes		5	8	6	8
Bolt Circle Diameter (in.)		5	6.5	5.5	6.5
Offset (mm)		0	17	50	17

¹Based on Curb Weight. ²w/L19 Reqs. Full-Floating 6000-lb. Cap. Rear Axle.

	TWO-WHEEL DRIVE MODELS		FOUR-WHEEL DRIVE MODELS	
MODEL	C1500 SUBURBAN	C2500 SUBURBAN	K1500 SUBURBAN	K2500 SUBURBAN
MODEL NUMBER	CC10906	CC20906	CK10906	CK20906
	GAS	GAS	GAS	GAS
OPTIONAL SUSPENSION				
OPTION	—	—	F60	F60
PAYLOAD (Max. lbs.) ¹	—	—	2356	3565
GVWR (lbs.)	—	—	7200	8600
GAWR (lbs.) Front Rear	— —	— —	3925 4000	4250 6000
FRONT SUSPENSION Type	—	—	Independent Torsion Bar	Independent Torsion Bar
Standard Spring Capacity (Total lbs.)	—	—	3925	4250
Front Shock Absorbers Piston Diameter (mm)	—	—	32	32
Front Stabilizer Bar Diameter (in.)	—	—	1.18	1.18
REAR SUSPENSION Type	—	—	Semi-Elliptic 2-Stage Multi-Leaf	Semi-Elliptic 2-Stage Multi-Leaf
Standard Spring Capacity (Total lbs.)	—	—	4000	6000
Leaves Per Spring	—	—	5	8
Leaf Tot. Thickness (in.)	—	—	2.26	2.93
Rear Shock Absorbers Piston Diameter (mm)	—	—	32	32
Rear Stabilizer Bar Diameter (in.)	—	—	.87	.87
FRONT AXLE Type	—	—	—	—
Make	—	—	—	—
Maximum Capacity (lbs.)	—	—	3925	4250
Standard Hub Locks	—	—	—	—
Pinion/Ring Gear Type	—	—	Hypoid	Hypoid
REAR AXLE Type	—	—	Semi-Floating	Semi-Floating
Make	—	—	GM	GM
Maximum Capacity (lbs.)	—	—	4000	6000
Pinion/Ring Gear Type	—	—	Hypoid	Hypoid
STANDARD TIRES	—	—	Tubeless SBR LT225/75R16D	Tubeless SBR LT245/75R16C
Capacity (lbs) Front/Rear	— —	— —	2335 65	3042 80
Inflation (psi) maximum	—	—	706	678
Revolutions per mile @ 45 mph	—	—	706	678
WHEELS Size (in.) Front/Rear	— —	— —	16.0 x 6.5	16.0 x 6.5
Capacity (lbs.)	—	—	2400	3042
Bolt Holes	—	—	6	8
Bolt Circle Diameter (in.)	—	—	5.5	6.5
Offset (mm)	—	—	50	17

¹Based on Curb Weight.

KEY: — - Not Available
 AS - All-Season
 SBR - Steel-Belted Radial Ply
 BW - Blackwall
 WW - Whitewall
 WL - White Lettered
 HWY - Highway
 ON-OFF - On-Off Road
 WOL - White Outline Lettered

WHEELS AND TIRES												
TIRE SIZE	TYPE	RPO	PLY	LOAD RANGE	TIRE CAPACITY (lbs.)	INFLATION (psi) max.	WHEEL SIZE (in.)	WHEEL CAPACITY (lbs.)	BOLT HOLES	BOLT CIRCLE dia. (in.)	OFFSET (mm)	REV.PER mile @ 45 mph
LT225/75R16D	AS/SBR/BW	QHP	8	D	2335	65	16.0x6.5	2400	6	5.5	50	706
LT225/75R16D	ON-OFF SBR/WW	QHR	8	D	2335	65	16.0x6.5	2400	6	5.5	50	706
P235/75R15XL	AS/SBR/WW	QHA	—	XL	1984	41	15.0x7.0	1984	5	5	0	722
P235/75R15XL	AS/SBR/WW	QHB	—	XL	1984	41	15.0x7.0	1984	5	5	0	722
LT245/75R16C	AS/SBR/BW	QIT	6	C	2205	50	16.0x6.5	2400	6	5.5	50	681
LT245/75R16C	ON-OFF SBR/BW	QBN	6	C	2205	50	16.0x6.5	2400	6	5.5	50	681
LT245/75R16C	ON-OFF SBR/WOL	QBN	6	C	2205	50	16.0x6.5	2400	6	5.5	50	681
LT245/75R16E	AS/SBR/BW	QIW	10	E	3042	80	16.0x6.5	3042	8	6.5	17	678
LT245/75R16E	AS/SBR/WOL	QIZ	10	E	3042	80	16.0x6.5	3042	8	6.5	17	678

OPTIONAL WHEELS						
RPO	DESCRIPTION	WHEEL SIZE (in.)	CAPACITY (lbs.) ea.	BOLT HOLES	BOLT CIRCLE dia. (in.)	OFFSET (mm)
N67 ¹	Wheels—Rally Wheel Trim (Adds Trim Rings and Special Hub Caps)	15 x 8.0	3045	5/6	5.0/5.5	127
N90 ¹	Wheels—Aluminum, Cast (Includes 15.0 x 7.0 Wheels and Special Hub Caps)	15 x 7.0	1843	5/6	5.0/5.5	13
PF4	Wheels - Aluminum, Cast	16 x 7.0	1702	6	5.5	50

¹ C/K 10906 Models Only.

TWO-WHEEL AND FOUR-WHEEL DRIVE MODELS				
MODEL	C1500 SUBURBAN	C2500 SUBURBAN	K1500 SUBURBAN	K2500 SUBURBAN
MODEL NUMBER	CC10906	CC20906	CK10906	CK20906
	GAS	GAS	GAS	GAS
FRAME				
Side Rail Dimensions Width (in.)	2.28	2.28	2.28	2.28
Depth (in.)	6.30	7.24	7.48	7.48
Thickness (in.)	.134	.165	.165	.165
Section Modulus Rails only (cu. in.)	2.74	4.11	4.15	4.15
RBM of Frame (lb. in.)	98,640	147,960	149,400	149,400
Yield Strength of Frame (psi)	36,000	36,000	36,000	36,000
Width Over Rails Front (in.)	45.3	45.3	45.3	45.3
Rear (in.)	36.3	36.3	36.3	36.3
Overall Length of Rail (in.)	208.3	208.3	208.0	209.4
STEERING				
Type	Var. Ratio Integral Power	Var. Ratio Integral Power	Var. Ratio Integral Power	Var. Ratio Integral Power
Steering Ratio On Center/At Lock	16/13:1	16/13:1	16/13:1	16/13.5:1
Turning Diameter Curb-To-Curb (ft.)	45.8	41.4	47.8	46.4
Wall-To-Wall (ft.)	47.4	43.6	49.6	47.9
BRAKES				
GVWR (lbs.)	6800	8600	7200	8600
Type Rear-Wheel Anti-Lock Braking System	Vac. Power Front Disc/ Rear Drum	Vac. Power Front Disc/ Rear Drum	Vac. Power Front Disc/ Rear Drum	Vac. Power Front Disc/ Rear Drum
Booster Diaphragm Diameter (in.)	9.5 x 9.5 Tandem	9.5 x 9.5 Tandem	9.5 x 9.5 Tandem	9.5 x 9.5 Tandem
Front Rotor Size Diameter x Thickness (in.)	11.57 x 1.25	12.50 x 1.26	11.57 x 1.25	12.50 x 1.26
Front Facing Contact Per Axle (sq. in.)	34.8	38.0	34.8	38.0
Rear Drum Size Diameter x Width (in.)	11.15 x 2.75	13.0 x 2.5	11.15 x 2.75	13.0 x 2.5
Rear Facing Contact Per Axle (sq. in.)	115.84	116.73	115.84	116.73
Parking Brake Type	Cable To Rear Wheels	Cable To Rear Wheels	Cable To Rear Wheels	Cable To Rear Wheels

TWO AND FOUR-WHEEL DRIVE MODELS		
MODEL	C/K SUBURBAN	
MODEL NUMBER	C/K 10906 - C/K 20906	
	GAS	
ELECTRICAL		
ENGINE	5.7L V8	7.4L V8
STANDARD BATTERY		
Cold Cranking Amps @ 0° F	630	630
@ - 20° F	470	470
Reserve Capacity Minutes @ 80° F	115	115
STANDARD ALTERNATOR		
Max. Capacity (Amps)	100	100
Max Watts @ 12 Volts	1200	1200
Nominal Amp @ Idle approximately	54	54
Drive Pulley Ratio	3.2:1	3.2:1
Model Number	CS130	CS130
OPTIONAL ALTERNATOR¹	w/C69 or (C36 and C49)	w/C69 or (C36 and C49)
Max. Capacity (Amps)	105	105
Max. Watts @ 12 Volts	1260	1260
Nominal Amp @ Idle approximately	63	63
Drive Pulley Ratio	3.2:1	3.2:1
Model Number	CS130	CS130
OPTIONAL ALTERNATOR¹	w/C60 and (C36 or C49)	w/C60 and (C36 or C49)
Max. Capacity (Amps)	100	100
Max. Watts @ 12 Volts	1200	1200
Nominal Amp @ Idle approximately	54	54
Drive Pulley Ratio	3.2:1	3.2:1
Model Number	CS130	CS130

¹NOTE: This Alternator is Available Only as Part of Noted RPO.

ALTERNATOR CURVES

Note: Refer to Electrical Charts for Model Application.

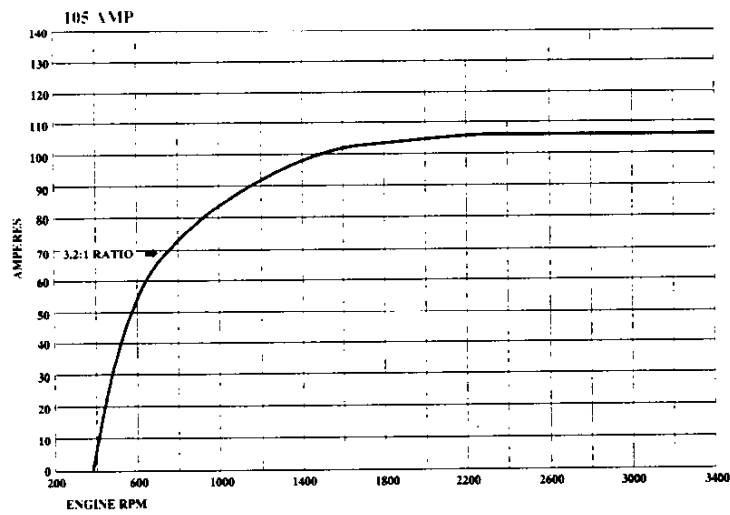
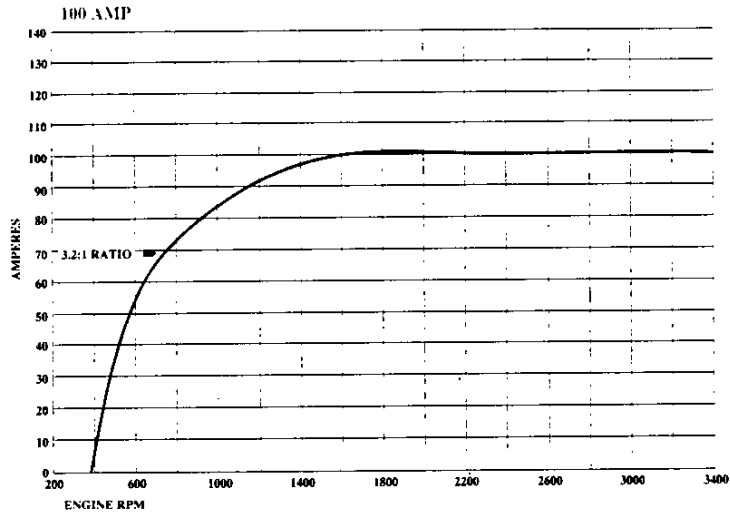

C/K SUBURBAN

TWO-WHEEL DRIVE MODELS				FOUR-WHEEL DRIVE MODELS		
MODEL	C1500 SUBURBAN	C2500 SUBURBAN		K1500 SUBURBAN	K2500 SUBURBAN	
MODEL NUMBER	CC10906	CC20906		CK10906	CK20906	
STANDARD COOLING SYSTEM						
ENGINE	5.7L V8	5.7L V8	7.4L V8	5.7L V8	5.7L V8	7.4L V8
Radiator Thickness (in.)	.98	1.57	2.17	1.57	1.57	2.17
System Cap. (gal.)	4.3	4.3	6.1	4.3	4.3	6.1
Fan-No. Blades	3 x 19	3 x 19	5 x 20	3 x 19	3 x 19	5 x 20
x Diameter x Pitch (in.)	x 2.01	x 2.01	x 2.56	x 2.01	x 2.01	x 2.56
OPTIONAL COOLING SYSTEMS						
OPT. H.D. RADIATOR	V01	V01	—	V01	V01	—
Radiator Thickness (in.)	1.57	1.57	—	1.57	1.57	—
Systems Cap. (gal.)	4.3	4.3	—	4.3	4.3	—
Fan-No. Blades	5 x 19.5	5 x 19.5	—	5 x 19.5	5 x 19.5	—
x Diameter x Pitch (in.)	x 2.01	x 2.01	—	x 2.01	x 2.01	—
OPT. AIR CONDITIONING	C60	C60	C60	C60	C60	C60
Radiator Thickness (in.)	1.57	1.57	2.17	1.57	1.57	2.17
System Cap. (gal.)	4.3	4.3	6.1	6.2	4.3	6.1
Fan-No. Blades	5 x 19.5	5 x 19.5	7 x 19.5	5 x 20	5 x 19.5	7 x 19.5
x Diameter x Pitch (in.)	x 2.01	x 2.01	x 2.56	x 2.87	x 2.01	x 2.56
OPT. H.D. RADIATOR AND TRANS. OIL COOLER	V02 ¹	V02 ¹	V02 ¹	V02 ¹	V02 ¹	V02 ¹
Radiator Thickness (in.)	1.57	1.57	2.17	1.57	1.57	2.17
System Cap. (gal.)	4.3	4.3	6.1	6.2	4.3	6.1
Fan-No. Blades	5 x 19.5	5 x 19.5	7 x 19.5	5 x 20	5 x 19.5	7 x 19.5
x Diameter x Pitch (in.)	x 2.01	x 2.01	x 2.56	x 2.87	x 2.01	x 2.56

¹Included with Z82 Trailing.

DIMENSIONS

1992
C/K SUBURBAN

		TWO-WHEEL DRIVE MODELS		FOUR-WHEEL DRIVE MODELS	
MODEL		C1500 SUBURBAN	C2500 SUBURBAN	K1500 SUBURBAN	K2500 SUBURBAN
MODEL NUMBER		CC10906	CC20906	CK10906	CK20906
EXTERIOR DIMENSIONS					
BODY					
Wheelbase (in.)	WB	131.5	131.5	131.5	131.5
Overall Length (in.)	OAL	218.9	218.9	218.9	218.9
Overall Height (in.) Nominal	OAH	68.8	68.8	68.8	68.8
Maximum Width (in.)	OAW	76.4	76.4	76.4	76.4
Bumper To Axle (in.) Front	BA	34.9	34.9	34.9	34.9
Rear		52.5	52.5	52.5	52.5
Ground to Top of Rear Load Floor (in.)	—	25.9	25.9	25.9	25.9
Ground Clearance (in.) Front/Rear	—	7.0/8.4	7.8/7.8	8.6/9.0	8.7/7.7
SIGN PANEL AREA (in.)	Shaded Area	N/A	N/A	N/A	N/A

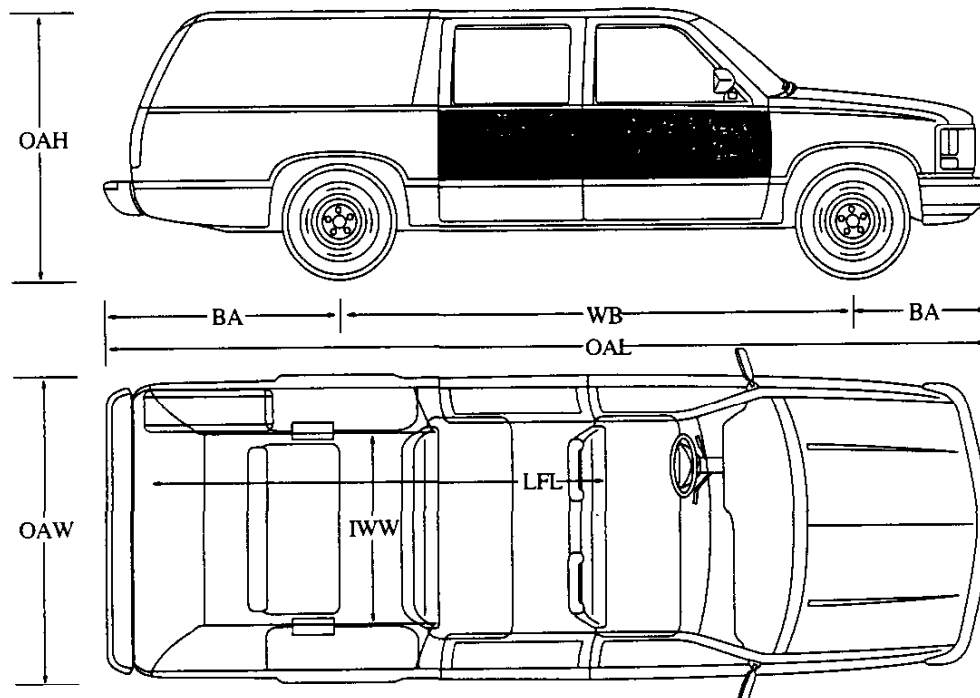

C/K SUBURBAN

		TWO-WHEEL DRIVE MODELS		FOUR-WHEEL DRIVE MODELS	
MODEL		C1500 SUBURBAN	C2500 SUBURBAN	K1500 SUBURBAN	K2500 SUBURBAN
MODEL NUMBER		CC10906	CC20906	CK10906	CK20906
INTERIOR DIMENSIONS					
Head Room (in.) Front/Middle/Rear	HR	34.7/39.3/38.2	34.7/39.3/38.2	34.7/39.3/38.2	34.7/39.3/38.2
Leg Room (in.) Front/Middle/Rear	LR	41.8/36.6/35.2	41.8/36.6/35.2	41.8/36.6/35.2	41.8/36.6/35.2
Shoulder Room (in.) Front/Middle/Rear	SR	66.0/66.1/66.0	66.0/66.1/66.0	66.0/66.1/66.0	66.0/66.1/66.0
Hip Room (in.) Front/Middle/Rear	HP	60.5/59.6/48.3	60.5/59.6/48.3	60.5/59.6/48.3	60.5/59.6/48.3
Cargo Volume (cu. ft.) w/Front Seat w/Front, Middle Seat w/Front, Middle, Rear Seats	CV	175.9 103.7 50.6	175.9 103.7 50.6	175.9 103.7 50.6	175.9 103.7 50.6
Load Floor Length (in.) w/Front Seat w/Front, Middle Seat w/Front, Middle, Rear Seats	LFL	98.8 65.0 31.7	98.8 65.0 31.7	98.8 65.0 31.7	98.8 65.0 31.7
Interior Width at Floor (in.)	—	66.1	66.1	66.1	66.1
Interior Width at Wheelhousing (in.)	IWW	48.5	48.5	48.5	48.5
FUEL TANK					
Standard Tank Nominal (gal.)		42	42	42	42
Location of Tank		Inboard Center Behind Rear Axle	Inboard Center Behind Rear Axle	Inboard Center Behind Rear Axle	Inboard Center Behind Rear Axle
Location of Filler		Left Side (Rear)	Left Side (Rear)	Left Side (Rear)	Left Side (Rear)

OPTIONS

1992

C/K SUBURBAN

KEY S - Standard
O - Optional
— Not Available

- 1. C1500 (4x2) CC10906 ZW9 Panel Rear Doors
- 2. C1500 (4x2) CC10906 E55 Tailgate
- 3. C2500 (4x2) CC20906 ZW9 Panel Rear Doors
- 4. C2500 (4x2) CC20906 E55 Tailgate
- 5. K1500 (4x4) CK10906 ZW9 Panel Rear Doors
- 6. K1500 (4x4) CK10906 E55 Tailgate
- 7. K2500 (4x4) CK20906 ZW9 Panel Rear Doors
- 8. K2500 (4x4) CK20906 E55 Tailgate

NOTE: Refer to Dealer Order Guide for Updated Option Availability.

OPTION	CODE	DESCRIPTION	RESTRICTIONS	MODELS							
				2-WHEEL DRIVE				4-WHEEL DRIVE			
				1	2	3	4	5	6	7	8
AIR CONDITIONING Front Front and Rear	C60 C69	Incl w/C69 Front/Rear Air Incls C60 Front Air Conditioning		O	O	O	O	O	O	O	O
AXLE, REAR	G80	Locking Differential		O	O	O	O	O	O	O	O
COLD CLIMATE PACKAGE	V10	Incls Engine Block Heater		O	O	O	O	O	O	O	O
CONVENIENCE PACKAGE Driver's	ZQ2	Incls Power Door Locks and Side Door Power Windows	Reqs YE9 Silverado	O	O	O	O	O	O	O	O
Operating	ZQ3	Incls Tilt Wheel and Speed Control		O	O	O	O	O	O	O	O
COOLING SYSTEM Engine Oil Radiator and Transmission Oil, Heavy-Duty	KC4 V02	Incl w/Z82 Trailing Incl w/Z82 Trailing	Reqs V02 Cooling	O	O	O	O	O	O	O	O
DOOR LOCK SYSTEM, POWER	AU3	Four Side Doors and Rear Panel Door	Incl w/ZQ2 or YE9 Silverado	O	O	O	O	O	O	O	O
ENGINES 5.7-liter V8 EFI 7.4-liter V8 EFI	L05 L19	(See Powertrains)		S	S	S	S	S	S	S	S
GLASS	AJ1	Deep Tinted		O	O	O	O	O	O	O	O
HEATER	C36	Auxiliary, Rear Passenger		O	O	O	O	O	O	O	O
LAMPS, ROOF MARKER	U01	Five, Amber	N/A YF5 California Emissions	O	O	O	O	O	O	O	O
LICENSE PLATE BRACKET	VK3	Front		O	O	O	O	O	O	O	O
MIRRORS, EXTERIOR Outside, Electric	D48	Remote Electric	Avail Only w/YE9 and ZQ2	O	O	O	O	O	O	O	O
MOLDING	B71		(Reqs LT245 Tires) Available w/ZY1 Paint or ZY2, ZY3 or ZY4 When Color Code 2 is 41,76,96 or 97. See Order Guide For Additional Restrictions.	—	—	—	—	—	—	—	—
PAINT, EXTERIOR Solid Conventional Two-Tone Special Two-Tone Deluxe Two-Tone	ZY1 ZY2 ZY3 ZY4	(See Color and Trim)		O	O	O	O	O	O	O	O
RADIO EQUIPMENT Electronically-Tuned AM/FM Stereo Radio w/Seek-Scan and Digital Clock	UM7	14 Presets, Digital Display, Two 3.5" Front Speakers/2 4" x 10" Rear Speakers, 28 Watts Total Power Output.		O	O	O	O	O	O	O	O
Electronically-Tuned AM /FM Stereo Radio w/Seek-Scan, Stereo Cassette Tape and Digital Clock	UM6	14 Presets, Digital Display, Two 3.5" Front Speakers/2 4" x 10" Rear Speakers, 28 Watts Total Power Output.		O	O	O	O	O	O	O	O
Electronically-Tuned AM Stereo/FM Stereo Radio w/Seek-Scan, Stereo Cassette Tape w/Search- Repeat, Graphic Equalizer and Digital Clock	UX1	14 Presets, Digital Display, Two 3.5" Front Speakers/2 4" x 10" Rear Speakers, 28 Watts Total Power Output.		O	O	O	O	O	O	O	O
Speakers	U88	Premium Speaker System	Reqs YE9 Silverado, ZQ2 Conv. Group and UX1 Radio	O	O	O	O	O	O	O	O
Radio Delete	UL5			O	O	O	O	O	O	O	O

- KEY S - Standard
 O - Optional
 — Not Available
- 1. C1500 (4x2) CC10906 ZW9 Panel Rear Doors
 - 2. C1500 (4x2) CC10906 E55 Tailgate
 - 3. C2500 (4x2) CC20906 ZW9 Panel Rear Doors
 - 4. C2500 (4x2) CC20906 E55 Tailgate
 - 5. K1500 (4x4) CK10906 ZW9 Panel Rear Doors
 - 6. K1500 (4x4) CK10906 E55 Tailgate
 - 7. K2500 (4x4) CK20906 ZW9 Panel Rear Doors
 - 8. K2500 (4x4) CK20906 E55 Tailgate

NOTE: Refer to Dealer Order Guide for Updated Option Availability.

OPTION	CODE	DESCRIPTION	RESTRICTIONS	MODELS							
				2-WHEEL DRIVE				4-WHEEL DRIVE			
				1	2	3	4	5	6	7	8
REAR WINDOW EQUIPMENT Convenience Package	ZP6	Incls C49 Rear Window Defogger and C25 Rear Window Wiper		O	O	O	O	O	O	O	O
Wiper Washer System	C25	Included w/ZP6 Convenience Package		O	O	O	O	O	O	O	O
Defogger, Rear Window	C49	Electric	w/ZW9 Reqs YE9 Silverado	O	O	O	O	O	O	O	O
SEATING One of the Following Must Be Chosen: Center, Folding				O	O	O	O	O	O	O	O
Center and Rear Seat	AT5 AS3	Incl w/AS3 Center and Rear Seat; Incls Shoulder Belts Incls AT5 Center Folding Seat; Available with Rear Seat Shoulder Belts	Reqs HA or HB Tires on R/V1500	O	O	O	O	O	O	O	O
Rear Seat Delete	YG4			O	O	O	O	O	O	O	O
Power Drivers Seat	AG9		Reqs Split Bench or Reclining Bucket Seat	O	O	O	O	O	O	O	O
SILVERADO	YE9	(See Trim Level Section)		O	O	O	O	O	O	O	O
SKID PLATE PACKAGE	NZZ	Incls Fuel Tank Shield		—	—	—	—	O	O	O	O
SPRINGS	F60	Front, Heavy-Duty; Capacity 1963-lb. each; (K1500) 2125-lb. each (K2500)	Recommended for Front Mounted Applications Only in V1500 Applications	—	—	—	—	O	O	O	O
STRIPING	D85	Refer to Color Charts	Reqs ZY1 or ZY2 Paint	O	O	O	O	O	O	O	O
TACHOMETER	U16			O	O	O	O	O	O	O	O
TIRE EQUIPMENT		(See Wheels and Tires for Details)									
LT225/75R16D	QHP		K1500 Only	S	S	—	—	S	S	—	—
LT225/75R16D	QHR		K1500 Only	O	O	—	—	O	O	—	—
P235/75R15XL	QHA		C1500 Only	O	O	—	—	O	O	—	—
P235/75R15XL	QHB		C1500 Only	O	O	—	—	O	O	—	—
LT245/75R16C	QIT		K1500 Only	—	—	—	—	O	O	—	—
LT245/75R16C	QBN		K1500 Only	—	—	S	S	—	—	S	S
LT245/75R16C	QBX		K1500 Only	—	—	—	—	—	—	O	O
LT245/75R16E	QIW			O	O	O	O	O	O	O	O
LT245/75R16E	QIZ			O	O	O	O	O	O	O	O
SPECIAL TRAILERING EQUIPMENT	Z82	Heavy-Duty; Incls Platform Hitch, Wiring Harness and V02 Heavy-Duty Radiator and Trans. Oil Cooler and KC4 Engine Oil Cooler		O	O	O	O	O	O	O	O
TOW HOOKS	V76	Front Mounted	Standard on K models	O	O	O	O	—	—	—	—
TRANSMISSION 4-Speed Auto w/Overdrive	MX0	(See Powertrains)		S	S	S	S	S	S	S	S
WHEEL TRIM	P01	Wheel Covers, Bright	N/A N90 Rally or PF4 Wheels (K1500 N/A w/QHA or QHB Tires)	O	O	O	O	O	O	O	O
WHEELS	P06 N90 PF4	Rally Wheel Trim Aluminum, Cast Aluminum, Cast	Not Available N90 or PF4 C1500 Only K1500 Only	O	O	O	O	O	O	O	O

SOLID COLOR

(ZY1)

Solid color paint (ZY1) is standard on all models. All painted areas of the body and front-end sheet metal are the same color. Below are the interior trim colors and exterior paint combinations recommended by Chevrolet. They are the only interior and exterior paint combinations allowed. Also included in the chart below is the optional D85 Stripe. For further information, refer to Seats and Interior Trim pages as well as the Ordering Guide.

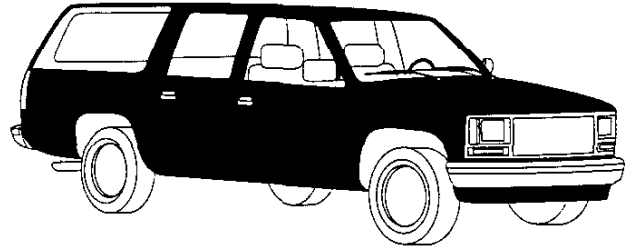

KEY: ●—Recommended Blank—Available

EXTERIOR COLORS		STRIPE COLORS	INTERIOR COLORS			
COLOR CODE 1	COLOR CODE 2	D85 (Optional)	Blue	Garnet	Beige	Gray
22 Brilliant Blue Met.	22 Brilliant Blue Met.	Lt. Blue	●			
27 Smoke Blue Met.	27 Smoke Blue Met.	Lt. Blue	●			
27 Smoke Blue Met.	27 Smoke Blue Met.	Silver				●
36 Teal Blue Met.	36 Teal Blue Met.	Lt. Teal Met.				●
41 Onyx Black	41 Onyx Black	Beige Met.			●	
41 Onyx Black	41 Onyx Black	Victory Red		●		
41 Onyx Black	41 Onyx Black	Silver				●
50 Summit White	50 Summit White	Cinnamon			●	
50 Summit White	50 Summit White	Lt. Blue	●			
50 Summit White	50 Summit White	Victory Red		●		
50 Summit White	50 Summit White	Silver				●
57 Sand Beige Met.	57 Sand Beige Met.	Cinnamon			●	
57 Sand Beige Met.	57 Sand Beige Met.	Victory Red		●		
74 Victory Red	74 Victory Red	Silver		●	●	●
76 Burnt Red Met.	76 Burnt Red Met.	Victory Red		●		
76 Burnt Red Met.	76 Burnt Red Met.	Silver				●
76 Burnt Red Met.	76 Burnt Red Met.	Beige Met.			●	
96 Quicksilver Met.	96 Quicksilver Met.	Victory Red		●		●
96 Quicksilver Met.	96 Quicksilver Met.	Lt. Blue	●			
96 Quicksilver Met.	96 Quicksilver Met.	Beige Met.			●	
97 Slate Met.	97 Slate Met.	Victory Red		●		
97 Slate Met.	97 Slate Met.	Silver				●

Note: On K2500 Models, Wheel Flares will be black w/ZY1 Paint Application.

CONVENTIONAL TWO-TONE

(ZY2)

Conventional two-tone (ZY2) paint colors are optional on C/K Suburban models. Color code 1 is applied to the areas above the lower feature line groove and Color code 2 is applied to the areas below. Below are the interior trim colors and exterior paint combinations recommended by Chevrolet. The only available color code 1/color code 2 exterior color combinations are those shown in the chart below. Also included in the chart below is the optional D85 Stripe. For further information, refer to Seats and Interior Trim pages as well as the Ordering Guide.

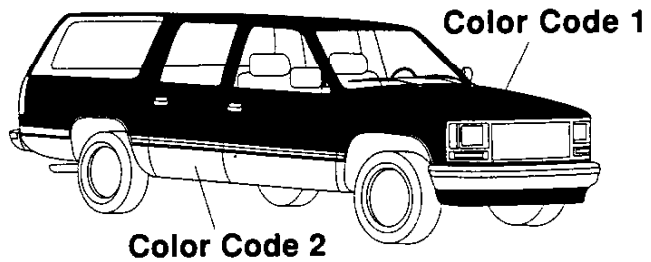

KEY: ●—Recommended Blank—Available Bold type—N/A K1500 w/B71 or K2500 models.

EXTERIOR COLORS		STRIPE COLORS		INTERIOR COLORS		
COLOR CODE 1	COLOR CODE 2	D85 (Optional)	Blue	Garnet	Beige	Gray
22 Brilliant Blue Met.	50 Summit White	Lt. Blue	●			
	96 Quicksilver Met.	Silver	●			
	97 Slate Met.	Lt. Blue	●			
27 Smoke Blue Met.	41 Onyx Black	Lt. Blue	●			
	41 Onyx Black	Silver				●
	50 Summit White	Lt. Blue	●			
	50 Summit White	Silver				●
36 Teal Blue Met.	50 Summit White	Lt. Teal Met.				●
	57 Sand Beige Met.	Beige Met.			●	
	96 Quicksilver Met.	Silver				●
	97 Slate Met.	Lt. Teal Met.				●
41 Onyx Black	36 Teal Blue Met.	Beige			●	
	36 Teal Blue Met.	Silver				●
	50 Summit White	Silver				●
	57 Sand Beige Met.	Beige			●	
	74 Victory Red	Victory Red		●		●
	76 Burnt Red Met.	Victory Red		●		
	96 Quicksilver Met.	Silver		●		●
	97 Slate Met.	Silver				●
	97 Slate Met.	Victory Red		●		
	97 Slate Met.	Victory Red				●
50 Summit White	22 Brilliant Blue Met.	Lt. Blue	●			
	27 Smoke Blue Met.	Lt. Blue	●			
	36 Teal Blue Met.	Silver				●
	41 Onyx Black	Victory Red		●		
	41 Onyx Black	Silver				●
	74 Victory Red	Victory Red		●		
	76 Burnt Red Met.	Victory Red		●		
	76 Burnt Red Met.	Silver				●
	97 Slate Met.	Victory Red		●		
	97 Slate Met.	Silver				●
57 Sand Beige Met.	41 Onyx Black	Cinnamon			●	
	76 Burnt Red Met.	Victory Red		●	●	
	97 Slate Met.	Victory Red			●	
74 Victory Red	41 Onyx Black	Silver		●		●
	50 Summit White	Silver		●		●
	96 Quicksilver Met.	Silver		●		●
	97 Slate Met.	Silver		●		●
76 Burnt Red Met.	41 Onyx Black	Silver				●
	41 Onyx Black	Victory Red		●		
	50 Summit White	Victory Red		●		
	57 Sand Beige Met.	Beige Met.		●	●	
	96 Quicksilver Met.	Silver		●		●
96 Quicksilver Met.	22 Brilliant Blue Met.	Lt. Blue	●			
	41 Onyx Black	Victory Red		●		●
	74 Victory Red	Victory Red		●		●
	76 Burnt Red Met.	Victory Red		●		●
	97 Slate Met.	Victory Red		●		●
97 Slate Met.	36 Teal Blue Met.	Silver				●
	41 Onyx Black	Victory Red		●		
	41 Onyx Black	Silver				●
	50 Summit White	Victory Red		●		
	50 Summit White	Silver				●
	74 Victory Red	Victory Red		●		
	74 Victory Red	Silver				●
	96 Quicksilver Met.	Victory Red		●		
96 Quicksilver Met.	Silver				●	

Note: On K2500 Models, Wheel Flares will be Color-keyed to lower body w/ZY2 Paint Application.

COLOR COMBINATIONS

SPECIAL TWO-TONE

(ZY3)

1992
C/K SUBURBAN
Color Code 1

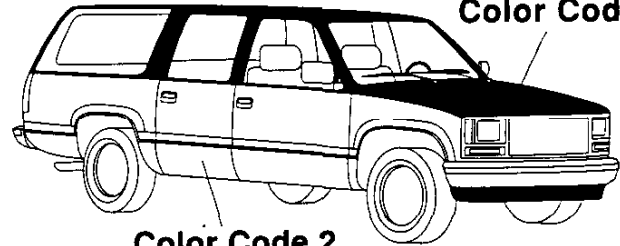

Special two-tone (ZY3) paint colors include decal striping. The areas above the striping are painted color code 1, and the areas below are painted color code 2. Below are the interior trim colors and exterior paint combinations recommended by Chevrolet. They are the only available interior and exterior combinations allowed. For further information, refer to Seats and Interior Trim pages as well as the Ordering Guide.

KEY: ●—Recommended Blank—Available **Bold**—N/A K1500 w/B71 or K2500 models

EXTERIOR COLORS		STRIPE COLORS	INTERIOR COLORS			
COLOR CODE 1	COLOR CODE 2	(STANDARD)	Blue	Garnet	Beige	Gray
22 Brilliant Blue Met.	50 Summit White	Lt. Blue/Dk. Blue	●			
	96 Quicksilver Met.	Lt. Blue/Slate	●			
	97 Slate Met.	Lt. Blue/Slate	●			
27 Smoke Blue Met.	41 Onyx Black	Lt. Blue/Dk. Blue	●			
	41 Onyx Black	Lt. Blue/Slate				●
	50 Summit White	Lt. Blue/Dk. Blue	●			●
36 Teal Blue Met.	50 Summit White	Lt. Teal/Silver				●
	96 Quicksilver Met.	Lt. Teal/Silver				●
	97 Slate Met.	Lt. Teal/Silver				●
41 Onyx Black	36 Teal Blue Met.	Vermillion/Beige			●	
	36 Teal Blue Met.	Vermillion/Silver				●
	50 Summit White	Vermillion/Beige				●
	57 Sand Beige Met.	Vermillion/Beige			●	
	74 Victory Red	Vermillion/Beige		●		●
	76 Burnt Red Met.	Vermillion/Silver		●		
	96 Quicksilver Met.	Vermillion/Silver		●		●
	97 Slate Met.	Vermillion/Beige		●		●
50 Summit White	22 Brilliant Blue Met.	Lt. Blue/Dk. Blue	●			
	27 Smoke Blue Met.	Lt. Blue/Dk. Blue	●			
	36 Teal Blue Met.	Lt. Blue/Dk. Blue				●
	41 Onyx Black	Vermillion/Garnet		●		
	41 Onyx Black	Vermillion/Silver				●
	74 Victory Red	Vermillion/Garnet		●		
	76 Burnt Red Met.	Vermillion/Garnet		●		
	76 Burnt Red Met.	Vermillion/Silver				●
	97 Slate Met.	Vermillion/Garnet		●		
	97 Slate Met.	Vermillion/Silver				●
57 Sand Beige Met.	41 Onyx Black	Vermillion/Beige			●	
	76 Burnt Red Met.	Vermillion/Beige		●	●	
	97 Slate Met.	Vermillion/Beige			●	
74 Victory Red	41 Onyx Black	Vermillion/Garnet		●		
	41 Onyx Black	Vermillion/Silver				●
	50 Summit White	Vermillion/Garnet		●		
	50 Summit White	Vermillion/Silver				●
	96 Quicksilver Met.	Vermillion/Silver		●		●
	97 Slate Met.	Vermillion/Garnet		●		
	97 Slate Met.	Vermillion/Silver				●
	97 Slate Met.	Vermillion/Silver				●
76 Burnt Red Met.	41 Onyx Black	Gold/Black				●
	50 Summit White	Vermillion/Garnet		●		
	57 Sand Beige Met.	Vermillion/Beige		●	●	
	96 Quicksilver Met.	Vermillion/Garnet		●		
	96 Quicksilver Met.	Vermillion/Silver				●
96 Quicksilver Met.	22 Brilliant Blue Met.	Lt. Blue/Slate	●			
	41 Onyx Black	Vermillion/Garnet		●		
	41 Onyx Black	Vermillion/Silver				●
	74 Victory Red	Vermillion/Silver		●		●
	76 Burnt Red Met.	Vermillion/Garnet		●		
	76 Burnt Red Met.	Vermillion/Silver				●
	97 Slate Met.	Vermillion/Garnet		●		
	97 Slate Met.	Vermillion/Silver				●
97 Slate Met.	36 Teal Blue Met.	Vermillion/Silver				●
	41 Onyx Black	Vermillion/Silver		●		●
	50 Summit White	Vermillion/Silver		●		●
	74 Victory Red	Vermillion/Silver		●		●
	96 Quicksilver Met.	Vermillion/Silver		●		●

NOTE: On K2500 Models, Wheel Flares be color-keyed to lower body color w/ZY3 Paint Application

C/K SUBURBAN

DELUXE TWO-TONE

(ZY4)

Deluxe two-tone (ZY4) paint colors include decal striping at upper paint break. Color code 1, is applied to the areas above the striping and below the lower feature line groove. Color code 2 is used below the striping and above the lower feature line groove. Below are the interior trim colors and exterior paint combinations recommended by Chevrolet. They are the only available interior and exterior combinations allowed. For further information, refer to Seats and Interior Trim pages as well as the Ordering Guide.

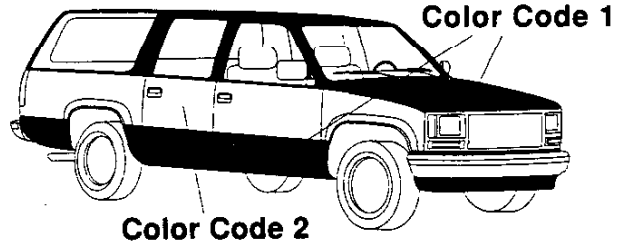

KEY: ●—Recommended Blank—Available **Bold**—N/A K1500 w/B71 or K2500 Models

EXTERIOR COLORS		STRIPE COLORS	INTERIOR COLORS			
COLOR CODE 1	COLOR CODE 2	(STANDARD)	Blue	Garnet	Saddle	Gray
22 Brilliant Blue Met.	50 Summit White	Lt. Blue/Dk. Blue	●			
	96 Quicksilver Met.	Lt. Blue/Slate	●			
	97 Slate Met.	Lt. Blue/Slate	●			
27 Smoke Blue Met.	41 Onyx Black	Lt. Blue/Dk. Blue	●			
	41 Onyx Black	Lt. Blue/Slate				●
	50 Summit White	Lt. Blue/Dk. Blue	●			●
36 Teal Blue Met.	50 Summit White	Lt. Teal/Silver				●
	96 Quicksilver Met.	Lt. Teal/Silver				●
	97 Slate Met.	Lt. Teal/Silver				●
41 Onyx Black	36 Teal Blue Met.	Vermillion/Beige			●	
	36 Teal Blue Met.	Vermillion/Silver				●
	50 Summit White	Vermillion/Beige				●
	57 Sand Beige Met.	Vermillion/Beige			●	
	74 Victory Red	Vermillion/Beige		●		●
	76 Burnt Red Met.	Vermillion/Silver		●		
	96 Quicksilver Met.	Vermillion/Silver		●		●
	97 Slate Met.	Vermillion/Beige		●		●
50 Summit White	22 Brilliant Blue Met.	Lt. Blue/Dk. Blue	●			
	27 Smoke Blue Met.	Lt. Blue/Dk. Blue	●			
	36 Teal Blue Met.	Lt. Blue/Dk. Blue				●
	41 Onyx Black	Vermillion/Garnet		●		
	41 Onyx Black	Vermillion/Silver		●		●
	74 Victory Red	Vermillion/Garnet		●		
	76 Burnt Red Met.	Vermillion/Garnet		●		
	76 Burnt Red Met.	Vermillion/Silver		●		●
	97 Slate Met.	Vermillion/Garnet		●		
	97 Slate Met.	Vermillion/Silver		●		●
57 Sand Beige Met.	41 Onyx Black	Vermillion/Beige			●	
	76 Burnt Red Met.	Vermillion/Beige		●	●	
	97 Slate Met.	Vermillion/Beige		●	●	
74 Victory Red	41 Onyx Black	Vermillion/Garnet		●		
	41 Onyx Black	Vermillion/Silver		●		●
	50 Summit White	Vermillion/Garnet		●		
	50 Summit White	Vermillion/Silver		●		●
	96 Quicksilver Met.	Vermillion/Silver		●		●
	97 Slate Met.	Vermillion/Garnet		●		
	97 Slate Met.	Vermillion/Silver		●		●
76 Burnt Red Met.	41 Onyx Black	Gold/Black				●
	50 Summit White	Vermillion/Garnet		●		
	57 Sand Beige Met.	Vermillion/Beige		●	●	
	96 Quicksilver Met.	Vermillion/Garnet		●		
	96 Quicksilver Met.	Vermillion/Silver		●		●
96 Quicksilver Met.	22 Brilliant Blue Met.	Lt. Blue/Slate	●			
	41 Onyx Black	Vermillion/Garnet		●		
	41 Onyx Black	Vermillion/Silver		●		●
	74 Victory Red	Vermillion/Garnet		●		
	74 Victory Red	Vermillion/Silver		●		●
	76 Burnt Red Met.	Vermillion/Garnet		●		
	76 Burnt Red Met.	Vermillion/Silver		●		●
	97 Slate Met.	Vermillion/Garnet		●		
	97 Slate Met.	Vermillion/Silver		●		●
97 Slate Met.	36 Teal Blue Met.	Vermillion/Silver		●		●
	41 Onyx Black	Vermillion/Silver		●		●
	50 Summit White	Vermillion/Silver		●		●
	74 Victory Red	Vermillion/Silver		●		●
	96 Quicksilver Met.	Vermillion/Silver		●		●

NOTE: On K2500 Models, Wheel Flares will be color-keyed to lower body color w/ZY4 Paint Application