

2731TRUC-93

# CHEVROLET

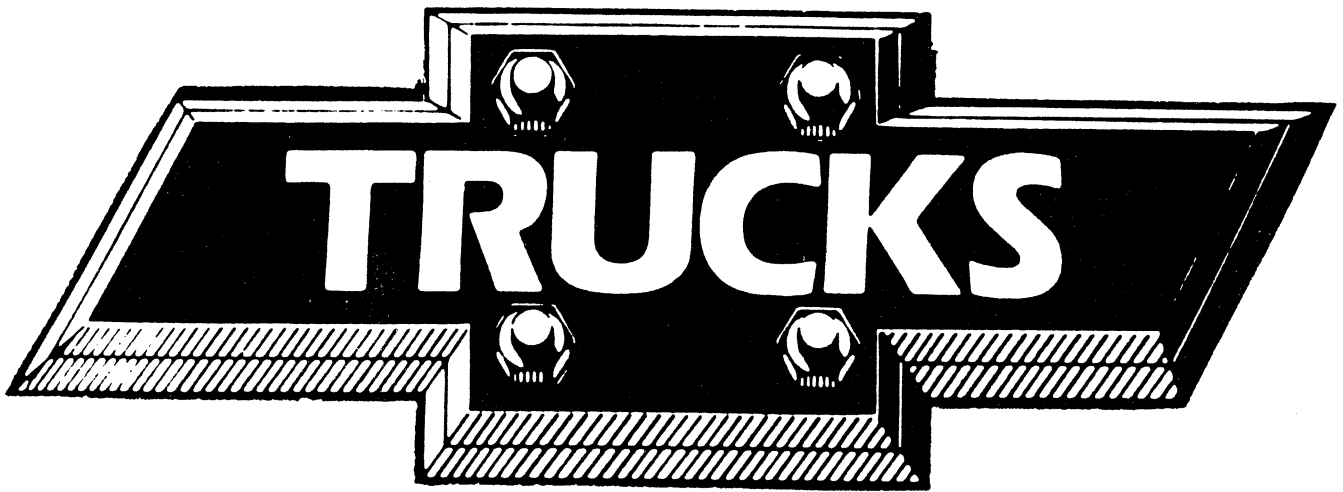

# 1993



1 9 9 3 F I N A L U P D A T E



C H E V R O L E T

L I G H T - D U T Y T R U C K T E C H N I C A L G U I D E

J A N U A R Y 1 9 9 3 , V O L U M E I I I

# C/K PICKUP

## MODEL SELECTION SUMMARY

Use the chart below to choose the model that fits your needs. Note that the Maximum Payload is based on curb weight. Also, the Maximum Gross Trailer Weight is based on vehicles that are properly equipped. See your 1993 Chevrolet Truck Order Guide for details.

| SERIES                            | MODEL NUMBER/<br>BODY CODE/<br>OPTION CODE              | PASSENGER CAPACITY<br>(STD./OPT.) | STANDARD ENGINE/<br>TRANS. | OPTIONAL ENGINE/<br>TRANS.   | GVWR<br>(LBS.) | GAWR<br>(LBS.)<br>FRONT/<br>REAR | MAXIMUM PAYLOAD<br>(LBS.)<br>BASED ON<br>CURB WT. | MAX. GROSS TRAILER WT./<br>TONGUE LOAD (LBS.)<br>PROPERLY EQUIPPED |
|-----------------------------------|---|-----------------------------------|----------------------------|--|----------------|----------------------------------|---|--|
| <b>TWO-WHEEL DRIVE MODELS</b>     |   |                                   |                            |  |                |                                  |   |  |
| <b>C1500 REGULAR CAB</b>          |   |                                   |                            |  |                |                                  |   |  |
| <b>SPORTSIDE SHORT BOX</b>        | CC10703/E62   | 3/2                               | 4.3L V6/M5                 | 4.3L V6/A4<br>5.0L V8/M5/A4<br>5.7L V8/M5/A4                                   | 5600           | 2950/3404                        | 1871  | 5000/600<br>6000/720<br>7500/900                                   |
| <b>FLEETSIDE SHORT BOX</b>        | CC10703/E63   | 3/2                               | 4.3L V6/M5                 | 4.3L V6/A4<br>5.0L V8/M5/A4<br>5.7L V8/M5/A4                                   | 5600           | 2950/3404                        | 1894  | 5000/600<br>6000/720<br>7500/900                                   |
| <b>FLEETSIDE 454 SS SHORT BOX</b> | CC10703/E63/<br>B4U                                     | 2/-                               | 7.4L V8/A4                 | —  | 5600           | 3150/3404                        | 1292  | 6000/720   |
| <b>FLEETSIDE LONG BOX WT1500</b>  | CC10903/E63/<br>VLA/YET                                 | 3/-                               | 4.3L V6/M5                 | 4.3L V6/A4   | 5600           | 2950/3404                        | 1747  | 5000/600   |
|                                   | CC10903/E63/<br>VLA/YFL                                 | 3/-                               | 4.3L V6/M5                 | 4.3L V6/A4   | 6100           | 3150/3686                        | 2231  | 5000/600   |
| <b>FLEETSIDE LONG BOX</b>         | CC10903/E63/<br>YET or YEV                              | 3/2                               | 4.3L V6/M5                 | 4.3L V6/A4<br>5.0L V8/M5/A4<br>5.7L V8/M5/A4                                   | 5600           | 2950/3404                        | 1747  | 5000/600<br>6000/720<br>7500/900                                   |
| <b>FLEETSIDE LONG BOX HD</b>      | CC10903/E63<br>(Reqs. YFL,<br>YFM, YFN<br>or YCN tires) | 3/2                               | 4.3L V6/M5                 | 4.3L V6/A4<br>5.0L V8/M5/A4<br>5.7L V8/M5/A4<br>6.2L V8/M5/A4                  | 6100           | 3150/3686                        | 2231  | 5000/600<br>6000/720<br>7500/900<br>5000/600                       |
| <b>C1500 EXTENDED CAB</b>         |   |                                   |                            |  |                |                                  |   |  |
| <b>SPORTSIDE SHORT BOX</b>        | CC10753/E62   | 6/5/3                             | 4.3L V6/M5                 | 4.3L V6/A4<br>5.0L V8/M5/A4<br>5.7L V8/M5/A4<br>6.2L V8/M5/A4                  | 6200           | 3500/3686                        | 2177  | 5000/600<br>6000/720<br>7500/900<br>5000/600                       |
| <b>FLEETSIDE SHORT BOX</b>        | CC10753/E63   | 6/5/3                             | 4.3L V6/M5                 | 4.3L V6/A4<br>5.0L V8/M5/A4<br>5.7L V8/M5/A4<br>6.2L V8/M5/A4                  | 6200           | 3500/3686                        | 2200  | 5000/600<br>6000/720<br>7500/900<br>5000/600                       |
| <b>FLEETSIDE LONG BOX</b>         | CC10953/E63   | 6/5/3                             | 4.3L V6/M5                 | 4.3L V6/A4<br>5.0L V8/M5/A4<br>5.7L V8/M5/A4<br>6.2L V8/M5/A4                  | 6200           | 3500/3686                        | 2051  | 5000/600<br>6000/720<br>7500/900<br>5000/600                       |
| <b>C2500 REGULAR CAB</b>          |   |                                   |                            |  |                |                                  |   |  |
| <b>FLEETSIDE LONG BOX</b>         | CC20903/E63   | 3/2                               | 4.3L V6/M5                 | 4.3L V6/A4<br>5.0L V8/M5/A4<br>5.7L V8/M5/A4<br>6.2L V8/M5/A4                  | 7200           | 3150/4670                        | 3172  | 6000/720<br>8000/960<br>8500/1000<br>6500/780                      |
|                                   |   |                                   |                            |  | 7200           | 3400/4800                        |   |  |
| <b>FLEETSIDE LONG BOX HD</b>      | CC20903/E63/<br>C6P/<br>YHH or YGK                      | 3/2                               | 4.3L V6/M5                 | 4.3L V6/A4<br>5.0L V8/M5/A4<br>5.7L V8/M5/A4<br>6.2L V8/M5/A4<br>6.5L V8/M5/A4 | 8600           | 3600/6000                        | 4178  | 6500/780<br>10000/1000<br>10000/1000<br>8000/960<br>9500/1000      |

See the following pages for additional 2- and 4- Wheel Drive Models.

# C/K PICKUP

| SERIES                                     | MODEL NUMBER/<br>BODY CODE/<br>OPTION CODE | PASSENGER CAPACITY<br>(STD./OPT.) | STANDARD ENGINE/<br>TRANS. | OPTIONAL ENGINE/<br>TRANS.   | GVWR<br>(LBS.) | GAWR<br>(LBS.)<br>FRONT/<br>REAR | MAXIMUM PAYLOAD<br>(LBS.)<br>BASED ON<br>CURB WT. | MAX. GROSS TRAILER WT./<br>TONGUE LOAD (LBS.)<br>PROPERLY EQUIPPED |
|--|--|-----------------------------------|----------------------------|--|----------------|----------------------------------|---|--|
| <b>TWO-WHEEL DRIVE MODELS</b>              |  |                                   |                            |  |                |                                  |   |  |
| <b>C2500 EXTENDED CAB</b>                  |  |                                   |                            |  |                |                                  |   |  |
| <b>FLEETSIDE SHORT BOX</b>                 | CC20753/E63                                | 6/5/3                             | 4.3L V6/M5                 | 4.3L V6/A4<br>5.0L V8/M5/A4<br>5.7L V8/M5/A4<br>6.2L V8/M5/A4                  | 7200           | 3600/4670                        | 3030  | 6000/720<br>8000/960<br>8500/1000<br>5500/660                      |
| <b>FLEETSIDE LONG BOX</b>                  | CC20953/E63                                | 6/5/3                             | 4.3L V6/M5                 | 4.3L V6/A4<br>5.0L V8/M5/A4<br>5.7L V8/M5/A4<br>6.2L V8/M5/A4                  | 7200           | 3600/4670                        | 2897  | 6000/720<br>8000/960<br>8500/1000<br>5500/660                      |
| <b>FLEETSIDE LONG BOX HD</b>               | CC20953/E63/<br>C6P/<br>YHH or YGK         | 6/5/3                             | 4.3L V6/M5                 | 4.3L V6/A4<br>5.7L V8/M5/A4<br>7.4L V8/M5/A4<br>6.2L V8/M5/A4<br>6.5L V8/M5/A4 | 8600           | 3600/6000                        | 3929  | 6500/780<br>10000/1000<br>10000/1000<br>8000/960<br>9500/1000      |
| <b>C3500 REGULAR CAB</b>                   |  |                                   |                            |  |                |                                  |   |  |
| <b>FLEETSIDE LONG BOX</b>                  | CC30903/E63<br>YGK or YHH                  | 3/2                               | 5.7L V8/M5                 | 5.7L V8/A4<br>7.4L V8/M5/A4<br>6.2L V8/M5/A4<br>6.5L V8/M5/A4                  | 9000           | 3600/6084                        | 4324  | 9500/1000<br>10000/1000<br>8000/960<br>9000/1000                   |
| <b>FLEETSIDE LONG BOX DUAL REAR WHEELS</b> | CC30903/E63/<br>R05                        | 3/2                               | 5.7L V8/M5                 | 5.7L V8/A4<br>7.4L V8/M5/A4<br>6.2L V8/M5/A4<br>6.5L V8/M5/A4                  | 10000          | 3600/7500                        | 5053  | 9500/1000<br>10000/1000<br>8000/960<br>9000/1000                   |
| <b>C3500 EXTENDED CAB</b>                  |  |                                   |                            |  |                |                                  |   |  |
| <b>FLEETSIDE LONG BOX</b>                  | CC30953/E63<br>YGK or YHH                  | 6/5/3                             | 5.7L V8/M5                 | 5.7L V8/A4<br>7.4L V8/M5/A4<br>6.2L V8/M5/A4<br>6.5L V8/M5/A4                  | 9000           | 3600/6084                        | 4053  | 9500/1000<br>10000/1000<br>8000/960<br>9000/1000                   |
| <b>FLEETSIDE LONG BOX DUAL REAR WHEELS</b> | CC30953/E63/<br>R05                        | 6/5/3                             | 5.7L V8/M5                 | 5.7L V8/A4<br>7.4L V8/M5/A4<br>6.2L V8/M5/A4<br>6.5L V8/M5/A4                  | 10000          | 3600/7500                        | 4782  | 9500/1000<br>10000/1000<br>8000/960<br>9000/1000                   |
| <b>C3500 CREW CAB</b>                      |  |                                   |                            |  |                |                                  |   |  |
| <b>SINGLE REAR WHEELS</b>                  | CC30943/E63                                | 6/5                               | 5.7L V8/M5                 | 5.7L V8/A4<br>7.4L V8/M5/A4<br>6.5L V8/M5/A4                                   | 9000           | 4100/6084                        | 3671  | 9500/1000<br>10000/1000<br>9000/1000                               |
| <b>SINGLE REAR WHEELS CAMPER SPECIAL</b>   | CC30943/E63/<br>Z81                        | 6/5                               | 5.7L V8/M5                 | 5.7L V8/A4<br>7.4L V8/M5/A4<br>6.5L V8/M5/A4                                   | 9600           | 4100/6084                        | 4221  | 9500/1000<br>10000/1000<br>9000/1000                               |
| <b>DUAL REAR WHEELS</b>                    | CC30943/E63/<br>R05                        | 6/5                               | 5.7L V8/M5                 | 5.7L V8/A4<br>7.4L V8/M5/A4<br>6.5L V8/M5/A4                                   | 10000          | 4100/7500                        | 4401  | 9500/1000<br>10000/1000<br>9000/1000                               |

See the following pages for 4-Wheel Drive Models.

# C/K PICKUP

| SERIES                           | MODEL NUMBER/<br>BODY CODE/<br>OPTION CODE | PASSENGER CAPACITY<br>(STD./OPT.) | STANDARD ENGINE/<br>TRANS. | OPTIONAL ENGINE/<br>TRANS.   | GVWR<br>(LBS.) | GAWR<br>(LBS.)<br>FRONT/<br>REAR | MAXIMUM PAYLOAD<br>(LBS.)<br>BASED ON<br>CURB WT. | MAX. GROSS TRAILER WT./<br>TONGUE LOAD (LBS.)<br>PROPERLY EQUIPPED |
|----------------------------------|--|-----------------------------------|----------------------------|--|----------------|----------------------------------|---|--|
| <b>FOUR-WHEEL DRIVE MODELS</b>   |  |                                   |                            |  |                |                                  |   |  |
| <b>K1500 REGULAR CAB</b>         |  |                                   |                            |  |                |                                  |   |  |
| <b>SPORTSIDE SHORT BOX</b>       | CK10703/E62                                | 3/2                               | 4.3L V6/M5                 | 4.3L V6/A4<br>5.0L V8/M5/A4<br>5.7L V8/M5/A4                                   | 6100           | 3600/3750                        | 1957  | 5000/600<br>6500/780<br>7000/840                                   |
| <b>FLEETSIDE SHORT BOX</b>       | CK10703/E63                                | 3/2                               | 4.3L V6/M5                 | 4.3L V6/A4<br>5.0L V8/M5/A4<br>5.7L V8/M5/A4                                   | 6100           | 3600/3750                        | 1957  | 5000/600<br>6500/780<br>7000/840                                   |
| <b>FLEETSIDE LONG BOX WT1500</b> | CK10903/E63/<br>VLA                        | 3/-                               | 4.3L V6/M5                 | 4.3L V6/A4   | 6100           | 3600/3750                        | 1828  | 5000/600   |
| <b>FLEETSIDE LONG BOX</b>        | CK10903/E63                                | 3/2                               | 4.3L V6/M5                 | 4.3L V6/A4<br>5.0L V8/M5/A4<br>5.7L V8/M5/A4<br>6.2L V8/M5/A4                  | 6100           | 3600/3750                        | 1828  | 5000/600<br>6500/780<br>7000/840<br>5500/660                       |
| <b>K1500 EXTENDED CAB</b>        |  |                                   |                            |  |                |                                  |   |  |
| <b>SPORTSIDE SHORT BOX</b>       | CK10753/E62                                | 6/5/3                             | 4.3L V6/M5                 | 4.3L V6/A4<br>5.0L V8/M5/A4<br>5.7L V8/M5/A4                                   | 6200           | 3600/3750                        | 1758  | 5000/600<br>6500/780<br>7000/840                                   |
| <b>SPORTSIDE SHORT BOX HD</b>    | CK10753/E62/<br>F44                        | 6/5/3                             | 4.3L V6/M5                 | 4.3L V6/A4<br>5.0L V8/M5/A4<br>5.7L V8/M5/A4<br>6.2L V8/M5/A4                  | 6600           | 3600/4800                        | 2082  | 5000/600<br>6500/780<br>7000/840<br>5500/660                       |
| <b>FLEETSIDE SHORT BOX</b>       | CK10753/E63                                | 6/5/3                             | 4.3L V6/M5                 | 4.3L V6/A4<br>5.0L V8/M5/A4<br>5.7L V8/M5/A4                                   | 6200           | 3600/3750                        | 1758  | 5000/600<br>6500/780<br>7000/840                                   |
| <b>FLEETSIDE SHORT BOX HD</b>    | CK10753/E63/<br>F44                        | 6/5/3                             | 4.3L V6/M5                 | 4.3L V6/A4<br>5.0L V8/M5/A4<br>5.7L V8/M5/A4<br>6.2L V8/M5/A4                  | 6600           | 3600/4800                        | 2082  | 5000/600<br>6500/780<br>7000/840<br>5500/660                       |
| <b>FLEETSIDE LONG BOX</b>        | CK10953/E63                                | 6/5/3                             | 4.3L V6/M5                 | 4.3L V6/A4<br>5.0L V8/M5/A4<br>5.7L V8/M5/A4                                   | 6200           | 3600/3750                        | 1530  | 5000/600<br>6500/780<br>7000/840                                   |
| <b>FLEETSIDE LONG BOX HD</b>     | CK10953/E63/<br>F44                        | 6/5/3                             | 4.3L V6/M5                 | 4.3L V6/A4<br>5.0L V8/M5/A4<br>5.7L V8/M5/A4<br>6.2L V8/M5/A4                  | 6600           | 3600/4800                        | 1854  | 5000/600<br>6500/780<br>7000/840<br>5500/660                       |
| <b>K2500 REGULAR CAB</b>         |  |                                   |                            |  |                |                                  |   |  |
| <b>FLEETSIDE LONG BOX</b>        | CK20903/E63                                | 3/2                               | 4.3L V6/M5                 | 4.3L V6/A4<br>5.0L V8/M5/A4<br>5.7L V8/M5/A4<br>6.2L V8/M5/A4                  | 7200           | 3750/4670                        | 2794  | 5500/660<br>7500/900<br>8500/840<br>5500/660                       |
| <b>FLEETSIDE LONG BOX HD</b>     | CK20903/E63/<br>C6P<br>YHH or YGK          | 3/2                               | 4.3L V6/M5                 | 4.3L V6/A4<br>5.7L V8/M5/A4<br>7.4L V8/M5/A4<br>6.2L V8/M5/A4<br>6.5L V8/M5/A4 | 8600           | 3750/6000                        | 3811  | 6000/720<br>10000/1000<br>10000/1000<br>8000/960<br>9000/1000      |

See the following page for 4-Wheel Drive Models.

# C/K PICKUP

| SERIES                                     | MODEL NUMBER/<br>BODY CODE/<br>OPTION CODE | PASSENGER CAPACITY<br>(STD./OPT.) | STANDARD ENGINE/<br>TRANS. | OPTIONAL ENGINE/<br>TRANS.   | GVWR<br>(LBS.) | GAWR<br>(LBS.)<br>FRONT/<br>REAR | MAXIMUM PAYLOAD<br>(LBS.)<br>BASED ON<br>CURB WT. | MAX. GROSS TRAILER WT./<br>TONGUE LOAD (LBS.)<br>PROPERLY EQUIPPED |
|--|--|-----------------------------------|----------------------------|--|----------------|----------------------------------|---|--|
| <b>FOUR-WHEEL DRIVE MODELS (CONT.)</b>     |  |                                   |                            |  |                |                                  |   |  |
| <b>K2500 EXTENDED CAB</b>                  |  |                                   |                            |  |                |                                  |   |  |
| <b>FLEETSIDE SHORT BOX</b>                 | CK20753/E63                                | 6/5/3                             | 4.3L V6/M5                 | 4.3L V6/A4<br>5.0L V8/M5/A4<br>5.7L V8/M5/A4<br>6.2L V8/M5/A4                  | 7200           | 3750/4410                        | 2663  | 5500/660<br>7500/900<br>8500/1000<br>6500/780                      |
| <b>FLEETSIDE LONG BOX</b>                  | CK20953/E63                                | 6/5/3                             | 4.3L V6/M5                 | 4.3L V6/A4<br>5.0L V8/M5/A4<br>5.7L V8/M5/A4<br>6.2L V8/M5/A4                  | 7200           | 3750/4410                        | 2511  | 6000/720<br>7500/900<br>8500/1000<br>6500/780                      |
| <b>FLEETSIDE LONG BOX HD</b>               | CK20953/E63/<br>C6P<br>YGK or YHH          | 6/5/3                             | 4.3L V6/M5                 | 4.3L V6/A4<br>5.7L V8/M5/A4<br>7.4L V8/M5/A4<br>6.2L V8/M5/A4<br>6.5L V8/M5/A4 | 8600           | 3750/6000                        | 3514  | 6000/720<br>10000/1000<br>10000/1000<br>8000/960<br>9000/1000      |
| <b>K3500 REGULAR CAB</b>                   |  |                                   |                            |  |                |                                  |   |  |
| <b>FLEETSIDE LONG BOX</b>                  | CK30903/E63<br>YGK or YHH                  | 3/2                               | 5.7L V8/M5                 | 5.7L V8/A4<br>7.4L V8/M5/A4<br>6.2L V8/M5/A4<br>6.5L V8/M5/A4                  | 9200           | 3750/6084                        | 4151  | 9000/1000<br>10000/1000<br>7500/900<br>8500/1000                   |
| <b>FLEETSIDE LONG BOX DUAL REAR WHEELS</b> | CK30903/E63/<br>R05                        | 3/2                               | 5.7L V8/M5                 | 5.7L V8/A4<br>7.4L V8/M5/A4<br>6.2L V8/M5/A4<br>6.5L V8/M5/A4                  | 10000          | 3750/7500                        | 4670  | 9000/1000<br>10000/1000<br>7500/900<br>8500/1000                   |
| <b>K3500 EXTENDED CAB</b>                  |  |                                   |                            |  |                |                                  |   |  |
| <b>FLEETSIDE LONG BOX</b>                  | CK30953/E63<br>YGK or YHH                  | 6/5/3                             | 5.7L V8/M5                 | 5.7L V8/A4<br>7.4L V8/M5/A4<br>6.2L V8/M5/A4<br>6.5L V8/M5/A4                  | 9200           | 3750/6084                        | 3876  | 9000/1000<br>10000/1000<br>7500/900<br>8500/1000                   |
| <b>FLEETSIDE LONG BOX DUAL REAR WHEELS</b> | CK30953/E63/<br>R05                        | 6/5/3                             | 5.7L V8/M5                 | 5.7L V8/A4<br>7.4L V8/M5/A4<br>6.2L V8/M5/A4<br>6.5L V8/M5/A4                  | 10000          | 3750/7500                        | 4394  | 9000/1000<br>10000/1000<br>7500/900<br>8500/1000                   |
| <b>K3500 CREW CAB</b>                      |  |                                   |                            |  |                |                                  |   |  |
| <b>SINGLE REAR WHEELS</b>                  | CK30943/E63                                | 6/5                               | 5.7L V8/M5                 | 5.7L V8/A4<br>7.4L V8/M5/A4<br>6.5L V8/M5/A4                                   | 9200           | 4500/6084                        | 3482  | 9000/1000<br>10000/1000<br>8500/1000                               |
| <b>DUAL REAR WHEELS</b>                    | CK30943/E63/<br>R05                        | 6/5                               | 5.7L V8/M5                 | 5.7L V8/A4<br>7.4L V8/M5/A4<br>6.5L V8/M5/A4                                   | 10000          | 4500/7500                        | 4004  | 9000/1000<br>10000/1000<br>8500/1000                               |

## POWERTRAINS

Chevrolet offers a variety of engines, transmissions and rear axle ratios for the C/K Pickups. The following charts detail basic engine, transmission and axle specifications. See your 1993 Chevrolet Truck Order Guide for details.

| ENGINES   |                             |                             |                             |                                |                             |                       |                             |                                 |                                 |                                 |
|---|-----------------------------|-----------------------------|-----------------------------|--------------------------------|-----------------------------|-----------------------|-----------------------------|---------------------------------|---------------------------------|---------------------------------|
| ENGINE  | 4.3L V6                     | 4.3L V6 HD                  | 5.0L V8                     | 5.7L V8                        | 5.7L V8 HD                  | 7.4L V8               | 7.4L V8 HD                  | 6.2L V8 DIESEL                  | 6.2L V8 DIESEL HD               | 6.5L V8 TURBO DIESEL            |
| Order Code Restrictions                           | LB4<br>8500 GVW<br>or Under | LB4<br>Above<br>8500<br>GVW | L03<br>Up To<br>7200<br>GVW | L05<br>8500<br>GVW<br>or Under | L05<br>Above<br>8500<br>GVW | L19<br>454 SS<br>Only | L19<br>Above<br>8500<br>GVW | LH6<br>8500<br>GVW<br>or Under  | LL4<br>Above<br>8500<br>GVW     | L65<br>Above<br>8500<br>GVW     |
| SAE Net Horsepower<br>Horsepower @ RPM            | 165@<br>4000                | 155@<br>4000                | 175@<br>4000                | 210@<br>4000                   | 190@<br>4000                | 255@<br>4000          | 230@<br>3600                | 140@<br>3600                    | 150@<br>3500                    | 190@<br>3400                    |
| SAE Net Torque<br>Lb. Ft. @ RPM                   | 235@<br>2000                | 230@<br>2400                | 270@<br>2400                | 300@<br>2800                   | 300@<br>2400                | 405@<br>2400          | 385@<br>1600                | 255@<br>1900                    | 280@<br>2000                    | 380@<br>1700                    |
| Fuel System                                       | EFI                         | EFI                         | EFI                         | EFI                            | EFI                         | EFI                   | EFI                         | Gear Driven<br>Mechanical<br>FI | Gear Driven<br>Mechanical<br>FI | Gear Driven<br>Mechanical<br>FI |
| Clutch Size (in.)                                 | 11                          | 11                          | 12                          | 12                             | 12                          | -                     | 12                          | 12                              | 12                              | 12                              |
| Standard Battery<br>Cold Cranking<br>Amps @ 0°F   | 630                         | 630                         | 630                         | 630                            | 630                         | 630                   | 630                         | 2 @ 570 each                    | 2 @ 570 each                    | 2 @ 570 each                    |
| Standard Alternator<br>Maximum Capacity<br>(Amps) | 100                         | 100                         | 100                         | 100                            | 100                         | 100                   | 100                         | 100                             | 100                             | 100                             |

| TRANSMISSIONS              |  |   |  |  |
|----------------------------|--|---|--|--|
|                            | MANUAL   |   | AUTOMATIC  |  |
|                            | MANUAL 5-SPEED<br>W/OVERDRIVE<br>(HM290) (MG5) | MANUAL 5-SPEED<br>W/OVERDRIVE<br>AND DEEP LOW<br>HEAVY-DUTY<br>(NP4500) | ELECTRONIC<br>AUTOMATIC 4-SPEED<br>OVERDRIVE W/TORQUE<br>CONVERTER CLUTCH<br>(4L60-E)(M30) | ELECTRONICALLY-<br>CONTROLLED<br>AUTOMATIC 4-SPEED<br>W/OVERDRIVE<br>HEAVY-DUTY<br>(4L80-E)(MT1) |
| Transmission<br>Order Code | MM5  | MT8   | MX0  | MX0  |
| Application                | 8500 GVW or Under                              | See Order Guide   | 8500 GVW or Under  | Above 8500 GVW<br>and 454SS (B4U)  |
| Synchronized<br>Speeds     | 1/2/3/4/5                                      | 1/2/3/4/5   | —  | —  |
| Gear Ratios                |  |   |  |  |
| First                      | 4.02   | 6.34  | 3.06   | 2.48   |
| Second                     | 2.32   | 3.44  | 1.63   | 1.48   |
| Third                      | 1.40   | 1.71  | 1.00   | 1.00   |
| Fourth                     | 1.00   | 1.00  | 0.70   | 0.75   |
| Fifth                      | 0.73   | 0.73  | -  | -  |
| Reverse                    | 3.74   | 6.34  | 2.29   | 2.08   |
| Power Take Off             | No   | Yes   | No   | No   |



| REAR AXLES               |                           |      |      |      |                           |      |      |      |                           |      |      |      |                           |      |      |      |                               |      |      |      |                           |      |  |  |  |
|--------------------------|---------------------------|------|------|------|---------------------------|------|------|------|---------------------------|------|------|------|---------------------------|------|------|------|-------------------------------|------|------|------|---------------------------|------|--|--|--|
| Availability             | (See Order Guide)         |      |      |      | (See Order Guide)         |      |      |      | (See Order Guide)         |      |      |      | (See Order Guide)         |      |      |      | (See Order Guide)             |      |      |      |                           |      |  |  |  |
| Make/Capacity (lbs.)     | GM/<br>3404 Semi-Floating |      |      |      | GM/<br>3750 Semi-Floating |      |      |      | GM/<br>4800 Semi-Floating |      |      |      | GM/<br>6000 Full-Floating |      |      |      | GM/6000-6084<br>Full-Floating |      |      |      | GM/<br>7500 Full-Floating |      |  |  |  |
| Pinon and Ring Gear Type | Hypoid                    |      |      |      | Hypoid                    |      |      |      | Hypoid                    |      |      |      | Hypoid                    |      |      |      | Hypoid                        |      |      |      | Hypoid                    |      |  |  |  |
| Axle Ratio Code          | GU4                       | GU6  | GT4  | GT5  | GU4                       | GU6  | GT4  | GT5  | GU6                       | GT4  | GT5  | GU6  | GT4                       | GT5  | HC4  | GU6  | GT4                           | GT5  | HC4  | GT4  | GT5                       | HC4  |  |  |  |
| Ratio                    | 3.08                      | 3.42 | 3.73 | 4.10 | 3.08                      | 3.42 | 3.73 | 4.10 | 3.42                      | 3.73 | 4.10 | 3.42 | 3.73                      | 4.10 | 4.56 | 3.42 | 3.73                          | 4.10 | 4.56 | 3.73 | 4.10                      | 4.56 |  |  |  |
| Pinion Teeth             | 13                        | 12   | 11   | 10   | 13                        | 12   | 11   | 10   | 12                        | 11   | 10   | 12   | 11                        | 10   | 9    | 12   | 11                            | 10   | 9    | 11   | 10                        | 9    |  |  |  |
| Ring Gear Teeth          | 41                        | 41   | 41   | 41   | 41                        | 41   | 41   | 41   | 41                        | 41   | 41   | 41   | 41                        | 41   | 41   | 41   | 41                            | 41   | 41   | 41   | 41                        | 41   |  |  |  |
| Ring Gear Diameter (in.) | 8.5                       | 8.5  | 8.5  | 8.5  | 8.5                       | 8.5  | 8.5  | 8.5  | 9.5                       | 9.5  | 9.5  | 9.5  | 9.5                       | 9.5  | 9.5  | 10.5 | 10.5                          | 10.5 | 10.5 | 10.5 | 10.5                      | 10.5 |  |  |  |

Note: Axle Ratio availability depends on model, powertrain and emissions selected. See your 1993 Chevrolet Truck Order Guide for specific details.

| FRONT AXLES                      |                           |  |      |  |      |                         |      |  |      |                         |      |  |      |  |      |  |      |  |
|----------------------------------|---------------------------|--|------|--|------|-------------------------|------|--|------|-------------------------|------|--|------|--|------|--|------|--|
| Availability                     | K1500 & K2500 w/7200 GWWR |  |      |  |      | K2500 w/C6P & K3500     |      |  |      | K30943                  |      |  |      |  |      |  |      |  |
| Make/Capacity (lbs.)             | GM/3925                   |  |      |  |      | GM/4250                 |      |  |      | GM/4500                 |      |  |      |  |      |  |      |  |
| Pinon and Ring Gear Type         | Hypoid                    |  |      |  |      | Hypoid                  |      |  |      | Hypoid                  |      |  |      |  |      |  |      |  |
| Ratio                            | 3.42                      |  | 3.73 |  | 4.10 |                         | 3.42 |  | 3.73 |                         | 4.10 |  | 4.56 |  | 4.10 |  | 4.56 |  |
| Pinion Teeth                     | 12                        |  | 11   |  | 10   |                         | 12   |  | 11   |                         | 10   |  | 9    |  | 10   |  | 9    |  |
| Ring Gear Teeth                  | 41                        |  | 41   |  | 41   |                         | 41   |  | 41   |                         | 41   |  | 41   |  | 41   |  | 41   |  |
| Ring Gear Diameter (in.)         | 8.25                      |  | 8.25 |  | 8.25 |                         | 9.25 |  | 9.25 |                         | 9.25 |  | 9.25 |  | 9.75 |  | 9.75 |  |
| Differential Type Bearings, Type | 2-Pinion Tapered Roller   |  |      |  |      | 2-Pinion Tapered Roller |      |  |      | 2-Pinion Tapered Roller |      |  |      |  |      |  |      |  |
| Lubricant Capacity (pints)       | 4.5                       |  |      |  |      | 6                       |      |  |      | 6                       |      |  |      |  |      |  |      |  |

Note: Axle Ratio availability depends on model, powertrain and emissions selected. See your 1993 Chevrolet Truck Order Guide for specific details.

## TRIM LEVELS

Chevrolet offers C/K Pickups in two primary trim levels — “Cheyenne” and “Silverado.” The following chart details major standard features. See your 1993 Chevrolet Truck Order Guide for more details, including information on the WT 1500, Sport Pickup and 454SS.

| CHASSIS EQUIPMENT                          |   | CHEYENNE (STANDARD) | SILVERADO (YE9) |
|--|---|---------------------|-----------------|
| <b>KEY: ■ = STANDARD, — = NOT INCLUDED</b> |   |                     |                 |
| <b>BRAKES</b>                              | Power assisted; front disc, rear drum. Self-adjusting. Includes rear-wheel anti-lock system that operates in 2-wheel drive only.  | ■                   | ■               |
| <b>EXHAUST</b>                             | Single.   | ■                   | ■               |
| <b>FRAME</b>                               | All-welded ladder-type, channel design and boxed front-end section. Section modulus (cu. in.): Reg. Cabs — 2.66 on C/K 1500 and C/K 2500 (2WD). 3.27 on C/K 1500 and C/K 2500 (4WD). 5.26 on C/K 2500 /C6P and C/K3500 (2WD). 5.25 on C/K2500 w/C6P and C/K3500 (4WD). ext. Cabs — 3.37 on C/K1500 and C/K2500 (2WD). 4.06 on C/K 1500 and C/K2500 (4WD). 6.06 on C/K 2500 wC6P and C/K3500. Crew Cab — 7.49 on all models. | ■                   | ■               |
| <b>FUEL TANK</b>                           | 25.0 gallon (approx.) capacity on C/K 10703/53 and C/K 20753 models. 34.0 gallon (approx.) capacity on all other models.  | ■                   | ■               |
| <b>REAR AXLE</b>                           | Hypoid semi-floating on C/K 1500 and 2500. Full-floating on C/K 2500/C6P w/L19 or L65 and C/K3500.  | ■                   | ■               |

# C/K PICKUP

| CHASSIS EQUIPMENT (CONT.)                  |   |  | CHEYENNE<br>(STANDARD) | SILVERADO<br>(YES) |
|--|---|--|------------------------|--------------------|
| <b>KEY: ■ = STANDARD, — = NOT INCLUDED</b> |   |  |                        |                    |
| <b>SHOCK ABSORBERS</b>                     | 25mm: C/K 1500 front and rear;<br>32mm: Front on C/K2500 at 7200 lbs. GVWR and C/K3500. Rear on C/K2500 and 3500;<br>35mm: Front on C/K2500 at 8600 lbs. GVWR and Crew Cab. |  | ■                      | ■                  |
| <b>STABILIZER BAR</b>                      | 4x2: Front 1.25-inch; 4x4: Front 1.18-inch.   |  | ■                      | ■                  |
| <b>STEERING</b>                            | Integral power.   |  | ■                      | ■                  |
| <b>SUSPENSION, FRONT</b>                   | 4x2: Independent with computer-selected coil springs.<br>4x4: Independent with computer-selected torsion springs.   |  | ■                      | ■                  |
| <b>SUSPENSION, REAR</b>                    | C/K1500 and 2500: Semi-elliptic two-stage multi-leaf springs.<br>C/K3500: Semi-elliptic two-stage multi-leaf springs main/auxiliary.  |  | ■                      | ■                  |
| <b>TOW HOOKS</b>                           | Two front on 4x4 s.   |  | ■                      | ■                  |

| EXTERIOR EQUIPMENT          |  |  |   |   |
|-----------------------------|--|--|---|---|
| <b>AIR DAM</b>              | Black (not included on models at or above 8600 lbs. GVW).  |  | ■ | ■ |
| <b>BUMPER, FRONT</b>        | Chrome (w/black rub strip on Crew Cab).<br>Chrome with black rub strip with bright trim.   |  | ■ | — |
| <b>GRILLE</b>               | Molded plastic painted light argent with dark argent air intakes areas.<br>Deluxe dark argent grille with bright trim.   |  | ■ | — |
| <b>HEADLAMPS</b>            | Single rectangular halogen.<br>Dual composite halogen.   |  | ■ | — |
| <b>HORN</b>                 | Single electric low-note.<br>Dual low- and high-note.  |  | ■ | — |
| <b>INSULATION</b>           | Hood and cab-to-fender.  |  | — | ■ |
| <b>MIRRORS</b>              | RH and LH below-eye-line type with adjustable heads, painted black.<br>Chrome RH and LH below-eye-line type with adjustable heads (Crew Cab only).<br>Head size 9.0" x 6.5"  |  | ■ | ■ |
| <b>MOLDINGS</b>             | Black bodyside with bright trim and bright wheel opening (except K2500 C6P, K3500 and Sportside).<br>Crew Cab: Black trim with wheel opening molding (R04).  |  | — | ■ |
| <b>SPARE TIRE AND WHEEL</b> | Full-size on C/K1500. Optional on WT 1500, C/K2500 and 3500.   |  | ■ | ■ |
| <b>SPARE TIRE CARRIER</b>   | Winch-type carrier mounted under frame at rear. (C/K1500 only. Optional on WT 1500, C/K2500 and 3500.)   |  | ■ | ■ |
| <b>TIRES</b>                | Steel Belted Radials.<br>C/K1500 Reg. Cab (2WD) P225/75R15<br>Ext. Cab (2WD) P235/75R15<br>Reg. Cab (4WD) LT225/75R16C<br>Ext. Cab (4WD) LT245/75R16C<br>C/K2500 Reg. Cab (2WD)/(4WD) and Ext. Cab (2WD) LT225/75R16D<br>Ext. Cab (4WD) LT245/75R16C<br>All models with C6P LT245/75R16E<br>C/K3500 Reg. Cab, Ext. Cab and Crew Cab w/R04 LT245/75R16E<br>Reg. Cab and Ext. Cab (2WD) w/R05 LT225/75R16C/D<br>Reg. Cab, Ext. Cab (4WD) and Crew Cab R05 LT245/75R16D |  | ■ | ■ |
| <b>WHEELS</b>               | Argent painted steel wheels with black hub ornament.<br>15.0" x 6.0": C/K 1500 (2WD)<br>16.0" x 6.5": C/K 1500 (4WD), C/K 2500, C/K 3500 w/R04,<br>C/K 3500 w/R05 (front only)<br>16.0" x 6.0" C/K 3500 w/R05 (rear only)<br>Rally wheel trim.<br>Crew Cab: Full wheel covers, N/A R05.  |  | ■ | — |

## TIRES

| KEY: AS = ALL-SEASON SBR = STEEL-BELTED RADIAL PLY BW = BLACKWALL WW = WHITEWALL WL = WHITE LETTERED<br>HWY = HIGHWAY BL = BLACK LETTERED ON-OFF = ON-OFF ROAD WOL = WHITE OUTLINE LETTERED |                  |       |      |       |
|---|------------------|-------|------|-------|
|   |                  | FRONT | REAR | SPARE |
| P225/75R15  | AS/SBR/WL        | XEV   | YEV  | ZEV   |
| P225/75R15  | AS/SBR/BW        | XET   | YET  | ZET   |
| P235/75R15  | AS/SBR/BW        | XFL   | YFL  | ZFL   |
| P235/75R15  | AS/SBR/WW        | XFM   | YFM  | ZFM   |
| P235/75R15  | AS/SBR/WL        | XFN   | YFN  | ZFN   |
| P275/60R15  | AS/SBR/BW        | XCN   | YCN  | ZCN   |
| LT225/75R16C  | AS/SBR/BL        | XHE   | YHE  | ZHE   |
| LT225/75R16C  | ON-OFF/SBR/BW    | XHJ   | YHJ  | ZHJ   |
| LT225/75R16C  | ON-OFF/SBR/WOL   | XHN   | YHN  | ZHN   |
| LT225/75R16D  | AS/SBR/BW        | XHP   | YHP  | ZHP   |
| LT225/75R16D  | ON-OFF/AS/SBR/BW | XHR   | YHR  | ZHR   |
| LT245/75R16C  | AS/SBR/BW        | XBK   | YBK  | ZBK   |
| LT245/75R16C  | ON-OFF/SBR/BW    | XBN   | YBN  | ZBN   |
| LT245/75R16C  | ON-OFF/SBR/WL    | XBX   | YBX  | ZBX   |
| LT245/75R16E  | AS/SBR/BW        | XHH   | YHH  | ZHH   |
| LT245/75R16E  | ON-OFF/SBR/BW    | XGK   | YGK  | ZGK   |
| LT265/75R16C  | ON-OFF/SBR/BW    | XGL   | YGL  | ZGL   |
| LT265/75R16C  | ON-OFF/SBR/WOL   | XGM   | YGM  | ZGM   |
| 7.50-16D  | HWY/NYLON/BW     | XDE   | YDE  | ZDE   |
| 7.50-16D  | ON-OFF/NYLON/BW  | XDL   | YDL  | ZDL   |

## SPECIAL EQUIPMENT OPTIONS

The following special equipment is installed at the assembly plant. See your 1993 SEO catalog for details.

| SPECIAL EQUIPMENT OPTIONS  |                  |                          |
|--|------------------|--------------------------|
|  | LEAD TIME (DAYS) | OPTION CODE              |
| <b>Antifreeze, Permanent</b><br>(ethylene glycol protection to -34°F)  | 0                | <b>8B3</b>               |
| <b>Axle, Rear Full Floating</b><br>(C/K20903-20953/C6P only)   | 0                | <b>1TA</b>               |
| <b>Bumper</b><br>Front Painted Black.<br>Front Delete.   | 42<br>0          | <b>8E8</b><br><b>8H5</b> |
| <b>Carrier and Wheel, Spare</b><br>Does not include spare tire (C/K2500 and 3500 only, located under frame at rear).                                   | 42               | <b>5V1</b>               |
| <b>Cold Climate Package</b><br>(diesel models only, C/K2500 and 3500 only, N/A C/K20753. Provides use of Arctic grade fuel).                           | 42               | <b>8N1</b>               |
| <b>Cruise Control, Automatic</b>   | 42               | <b>5K3</b>               |
| <b>Generator</b><br>Delco 105-Amp (Requires 5.7L V8, 6.2L V8 or 7.4L V8)<br>Delco 124-Amp (Requires 5.0L V8 or 5.7L V8)                                | 42<br>42         | <b>8W5</b><br><b>8A3</b> |
| <b>Headlamps-on Warning</b><br>(included with Auxiliary Lighting TR9)  | 0                | <b>9W7</b>               |
| <b>Horn, High Note</b>   | 0                | <b>7Z1</b>               |
| <b>Meter, Engine Hour</b>  | 42               | <b>7Y4</b>               |
| <b>Mirror Delete, Outside Rearview</b>   | 0                | <b>9F2</b>               |
| <b>Mirror, Outside Rearview</b><br>(Velvac 6.5" x 6.0" Plain and 6.5" x 6.0" Convex, each side. Inside dimension of 77")<br>Black.<br>Stainless Steel. | 0<br>0           | <b>6M1</b><br><b>6L8</b> |

# C/K PICKUP

| SPECIAL EQUIPMENT OPTIONS (CONT.)  |                     |                          |
|--|---------------------|--------------------------|
|  | LEAD TIME<br>(DAYS) | OPTION<br>CODE           |
| <b>Mirror, Outside Rearview</b><br>(Velvac 6.5" x 10" Plain and 6.5" x 6.0" Convex, each side. Inside dimension of 77.")<br>Black<br>Stainless Steel                 | 0<br>0              | 6P3<br>6N9               |
| <b>Mirror, Outside Rearview</b><br>(Velvac Wideloop 6.5" x 10" Plain and 6.5" x 6" Convex, each side. Inside dimension of 96.")<br>White<br>Stainless Steel          | 0<br>0              | 8B2<br>8G9               |
| <b>Mirror, Outside Rearview</b><br>(Velvac 6.5" x 6.0" Convex Dual Spot — Stainless Steel. Available only w/West Coast Mirrors DG5.)                                 | 0                   | 9J7                      |
| <b>Mirror, Outside Rearview</b><br>(Velvac West Coast Type stainless steel.)   | 0                   | 9F8                      |
| <b>Ornamentation Delete</b><br>C/K 10703 only.   | 0                   | 8F2                      |
| <b>Paints: Solid.</b><br><b>Orange, Tangier</b> WE9417<br><b>Yellow, Wheatland</b> WE9418<br><b>Green, Woodland</b> WE9015<br><b>Tan, Doeskin</b> WE9403             | 0<br>0<br>0<br>0    | 9W4<br>9W3<br>9V5<br>9V9 |
| <b>Seats, Front Deletion</b><br>(retains LH/RH bucket type seat belts only. Rear seat remains in Extended Cab except when solid front bench seat trim is specified.) | 0                   | 8E2                      |
| <b>Seat, Restraint, Front</b><br>(dual mode retractor. Available in Blue or Beige only. N/A Bucket Seats or Silverado Trim.)   | 42                  | 9L8                      |
| <b>Seats, Bucket</b><br>w/o Center Console.  | 42                  | 8W7                      |
| <b>Seats, Rear Non-Installed</b><br>Extended Cab only.   | 0                   | 8Q3                      |
| <b>Shock Absorbers, Front and Rear Delco/Bilstein</b><br>(46mm gas pre-loaded. C10703/10903 only.)   | 42                  | 8X7                      |
| <b>Spring, Front Suspension</b><br>(provides higher production rated spring for Hy-Rail railroad operation.)   | 42                  | 8W9                      |
| <b>Spring, Rear Auxiliary</b><br>(for vehicle trim adjustment. C20903 only. Rated at 6000-pound GAWR.)   | 0                   | 5J9                      |
| <b>Steering Column, Tilt</b>   | 42                  | 9J6                      |
| <b>Switch, Dome Lamp</b><br>(RH door operated.)  | 0                   | 8M3                      |
| <b>Throttle, Hand</b><br>(adjustable pull type.)   | 0                   | 7L4                      |

| <b>INTERIOR EQUIPMENT</b>                  |   | <b>CHEYENNE<br/>(STANDARD)</b> | <b>SILVERADO<br/>(YE9)</b> |
|--|---|--------------------------------|----------------------------|
| <b>KEY: ■ = STANDARD, — = NOT INCLUDED</b> |   |                                |                            |
| <b>ARMRESTS</b>                            | RH and LH padded integral with door panels.   | ■                              | ■                          |
| <b>BUZZER</b>                              | Headlamp warning.   | ■                              | ■                          |
| <b>CAB BACK PANELS</b>                     | Color-keyed carpet.   | —                              | ■                          |
| <b>CIGARETTE LIGHTER</b>                   | Located on instrument panel.  | ■                              | ■                          |
| <b>CUP HOLDER</b>                          | Under dash. N/A with bucket seats.  | ■                              | ■                          |
| <b>DOME LAMP</b>                           | Switch in LH door jamb only (Two dome lamps with front door actuated switches on Crew Cab).<br>Switches in RH & LH front door jambs (Crew Cab includes switches in all four doors).   | ■<br>—                         | —<br>■                     |
| <b>DOOR PANELS</b>                         | Grained molded plastic.<br>Special color-keyed door trim panels with decorative inserts, map pockets, padded armrests and carpet trim.  | ■<br>—                         | —<br>■                     |
| <b>DOOR PILLAR AND ROOF SIDE PANELS</b>    | Color-keyed.  | —                              | ■                          |
| <b>DOOR SILL PLATE</b>                     | Color-keyed.  | ■                              | ■                          |
| <b>FLOOR COVERING</b>                      | Embossed black rubber mat.<br>Color-keyed front and rear. Removable color-keyed floor mats.   | ■<br>—                         | —<br>■                     |
| <b>GAGES</b>                               | Including fuel level, odometer, oil pressure, speedometer, telltale lights, engine temperature and voltmeter.   | ■                              | ■                          |
| <b>GLOVE BOX</b>                           | Latched door and beverage holder.   | ■                              | ■                          |
| <b>HEADLINER</b>                           | Vinyl with matching retainer moldings.<br>Full-length color-keyed cloth with matching retainer moldings.<br>Crew Cab: Full-length color-keyed cloth with matching retainer moldings, and three assist handles (RF, LR, RR).   | ■<br>—<br>■                    | —<br>■<br>■                |
| <b>HEATER</b>                              | Deluxe with windshield and side window defoggers.   | ■                              | ■                          |
| <b>INSULATION</b>                          | Provided on dash panels, cowl tops and sides, and doors. Extended Cabs have additional insulation on the rear quarter and back panels and on floor coverings. Extra insulation is provided with diesel engines.<br>Plus insulation on headliners.<br>Plus insulation on Regular Cab back panels.  | ■<br>—<br>—                    | ■<br>■<br>■                |
| <b>MIRRORS</b>                             | 10-inch rearview.   | ■                              | ■                          |
| <b>RADIO</b>                               | Electronically-tuned AM radio with two 4" x 6" standard front dash speakers and fixed mast antenna.<br>ETR AM/FM stereo radio with seek-scan and digital clock. Includes two 4" x 6" front dash standard speakers and two 4" x 6" rear extended range speakers located to rear above door.  | ■<br>—                         | —<br>■                     |
| <b>SEATS</b>                               | Scotchgard™ Protection on all cloth seats and cloth door panels.<br>Regular Cab: Front 3-passenger bench with head restraints and folding backrest.<br>Extended Cab: Front reclining 3-passenger 40/60 split bench with head restraints and folding rear bench seat.<br>Crew Cab: Front 3-passenger bench with head restraints and folding backrest and rear 3-passenger bench with folding backrest. | ■<br>■<br>■<br>■               | ■<br>■<br>■<br>■           |
| <b>STEERING WHEEL</b>                      | Custom urethane 4-spoke.<br>Sport urethane 4-spoke.   | ■<br>—                         | —<br>■                     |
| <b>STORAGE TRAY</b>                        | Full width behind seat on floor.  | —                              | ■                          |
| <b>SUNSHADE</b>                            | Color-keyed cloth RH and LH, padded.<br>Color-keyed cloth RH and LH, padded with cloth covering, storage strap on LH unit and visor mirror on RH unit.<br>Crew Cab: Padded, color-keyed RH and LH sunshades with extenders and illuminated mirrors. LH sunshade has storage strap.  | ■<br>—<br>—                    | —<br>■<br>■                |
| <b>TOOLS</b>                               | Mechanical jack and wheel wrench located behind front seat or on rear compartment floor.  | ■                              | ■                          |
| <b>TRIM PANELS</b>                         | Extended Cabs have rear, upper, lower and side trim panels and a molded color-keyed, cloth headliner with matching retaining moldings.  | ■                              | ■                          |
| <b>WINDOWS</b>                             | Solar-Ray tinted glass.   | ■                              | ■                          |
| <b>WINDSHIELD WIPERS</b>                   | Intermittent.   | ■                              | ■                          |

## PREFERRED EQUIPMENT GROUPS

Preferred Equipment Groups (PEGs) are convenient option packages that can save your customers money. They would pay appreciably more by buying all the options in a Preferred Equipment Group as individual options. (Savings based on a comparison of Manufacturer's Suggested Retail Price of option packages versus MSRP of individual options purchased separately.) See your 1993 Chevrolet Truck Order Guide and Vehicle Price Schedule for specific information and prices.

## OPTIONS

These options can be ordered individually in addition to the Preferred Equipment Groups if not already included. See your 1993 Chevrolet Truck Order Guide for specific availability and restrictions. The Option Code is listed in **bold type**.

|   |            |  |            |  |                 |
|---|------------|--|------------|--|-----------------|
| Air Conditioning .....  | <b>C60</b> | 6.2L V8 Diesel .....   | <b>LL4</b> | ETR AM Radio .....   | <b>UT5</b>      |
| Appearance Package: Chrome Grille,<br>Composite Headlamps & Dual<br>Horns(Incl. w/Silverado Decor) .....                        | <b>V22</b> | 6.5L V8 Turbo Diesel .....   | <b>L65</b> | ETR AM/FM Stereo Radio<br>w/Seek-Scan, Stereo Cassette/<br>Digital Clock .....   | <b>UM6</b>      |
| Axles, Rear (see Order Guide for GQ1):  |            | Alternative Fuel (LPG or CNG<br>Conversion Ready) .....  | <b>KL5</b> | ETR AM/FM Stereo Radio w/<br>Seek-Scan/Digital Clock .....   | <b>UM7</b>      |
| 3.08 .....  | <b>GU4</b> | Floor Covering   |            | ETR AM/FM Stereo Radio w/<br>Seek-Scan/Stereo Cassette with<br>Search/Repeat, Graphic<br>Equalizer/Digital Clock .....                                       | <b>UX1</b>      |
| 3.42 .....  | <b>GU6</b> | Full Floor Rubber, Color-Keyed .....   | <b>BG9</b> | Seat, Power Driver's Adjuster<br>(Crew Cab only) .....   | <b>AG9</b>      |
| 3.73 .....  | <b>GT4</b> | Glass, Deep Tinted, Sides and Rear<br>(Extended and Crew Cab only,<br>includes Swing-Out Windows A20<br>on Extended Cab) .....               | <b>AJ1</b> | Seat, Rear 3-Passenger Bench<br>not desired (Extended Cab Only) ...  | <b>YG4</b>      |
| 4.10 .....  | <b>GT5</b> |  |            | Shock Absorbers, Front and Rear,<br>Heavy-Duty (included w/Trailer<br>Special Equipment Z82) .....   | <b>F51</b>      |
| 4.56 .....  | <b>HC4</b> | GWWR (non-merchandised codes<br>for information only):   |            | Skid Plate (4x4 only) .....  | <b>NZZ</b>      |
| Axle, Rear Locking Differential .....   | <b>G80</b> | 5600 lbs .....   | <b>C5G</b> | Snow Plow Prep Package<br>(Reg. Cab 4x4 only) .....  | <b>VYU</b>      |
| Battery, Heavy-Duty, Auxiliary .....  | <b>TP2</b> | 6100 lbs .....   | <b>C5M</b> | Sport Equipment Package .....  | <b>BYP</b>      |
| Bedliner .....  | <b>BZY</b> | 6200 lbs .....   | <b>Q4B</b> | Sport Performance Package,<br>454SS Model .....  | <b>B4U</b>      |
| Bonus packages:   |            | 6600 lbs .....   | <b>C5S</b> | Springs, Front Heavy-Duty (4x4 only) ..  | <b>F60</b>      |
| (Manual Transmission only)  |            | 7200 lbs .....   | <b>C5Z</b> | Sport Handling Package (includes 46mm<br>Bilstein gas-filled shocks and<br>chrome wheels N83, C1500 only) ...  | <b>ZQ8</b>      |
| Work Package .....  | <b>R9A</b> | 8600 lbs .....   | <b>C6P</b> | Tachometer .....   | <b>U16</b>      |
| Convenience Package .....   | <b>R9C</b> | 9000 lbs .....   | <b>C6U</b> | Tow Hooks, Front (4x2 only) .....  | <b>V76</b>      |
| Delete .....  | <b>R9D</b> | 9200 lbs .....   | <b>C6W</b> | Trailer Special Equipment<br>(includes seven-lead wiring harness,<br>weight distributing hitch platform,<br>and other equipment depending on<br>model) ..... | <b>Z82</b>      |
| Bumper, Painted Rear Step .....   | <b>V43</b> | 9600 lbs .....   | <b>C6Y</b> | Transmissions  |                 |
| Bumper, Chromed Rear Step<br>w/ Rub Strip .....   | <b>VB3</b> | 10,000 lbs .....   | <b>C7A</b> | 5-Speed Manual<br>w/overdrive .....  | <b>MM5(MG5)</b> |
| Bumper, Chromed Front Deluxe<br>w/Rub Strip .....   | <b>VG3</b> | Harness, Wiring (seven-lead,<br>included w/Trailer Special<br>Equipment Z82) .....   | <b>UY7</b> | 5-Speed Manual with Deep Low<br>and Overdrive, H.D. ....   | <b>MT8</b>      |
| Bumper Guards, Front, Black .....   | <b>V27</b> | Lamps, Cargo Area .....  | <b>UF2</b> | 4-Speed Electronic Automatic<br>with OD and torque converter<br>clutch .....   | <b>MX0(M30)</b> |
| Camper Special Chassis Equipment<br>(Includes Camper Mirrors DF2,<br>seven-lead Wiring Harness,<br>Auxiliary Battery TP2) ..... | <b>Z81</b> | Lamps, Dome and Reading<br>(included w/Auxiliary Lighting TR9) .   | <b>C95</b> | 4-Speed Electronically<br>Controlled Automatic<br>w/Overdrive, H.D. ....   | <b>MX0(MT1)</b> |
| Carrier, Spare Wheel & Tire<br>(side mounted) .....   | <b>P13</b> | Lamps, Roof Marker (included<br>w/Dual Rear Wheels R05) .....  | <b>U01</b> | Wheel Covers .....   | <b>P01</b>      |
| Cold Climate Package<br>(includes Engine Block Heater,<br>antifreeze protection to -32°F and<br>special insulation) .....       | <b>V10</b> | License Plate Bracket, Front .....   | <b>VK3</b> | Wheels   |                 |
| Convenience Package, Driver's<br>(includes ComfortTilt™ Steering<br>and Electronic Speed Control) .....                         | <b>ZQ3</b> | Lighting Auxiliary (dome, reading,<br>ashtray, glove box and underhood<br>lamps) .....   | <b>TR9</b> | Rally Trim .....   | <b>P06</b>      |
| Convenience Package, Operating<br>(includes Power Door Locks and<br>Power Windows) .....  | <b>ZQ2</b> | Mirrors, Exterior, Below-eye-line<br>Type (LH and RH stainless steel.<br>Mirror head 9.0" x 6.5") .....                                      | <b>D45</b> | Cast Aluminum (15" x 7") .....   | <b>N90</b>      |
| Cooling System  |            | Mirrors, Exterior, Remote Control<br>Below-eye-line, Electric,<br>Painted (Crew Cab) .....   | <b>D48</b> | Cast Aluminum (16" x 7") .....   | <b>PF4</b>      |
| Engine Oil Cooler .....   | <b>KC4</b> | Mirrors, Exterior Camper Type<br>(LH and RH stainless steel. Mirror<br>head: 7.5" x 10.5". Included w/<br>Camper Special Equipment Z81) .... | <b>DF2</b> | Chrome Wheels (C1500) .....  | <b>N83</b>      |
| Heavy-Duty Radiator .....   | <b>V01</b> | Moldings, Body Side and Wheel<br>Opening (Black) .....   | <b>B84</b> | Dual Rear (C/K3500 only) .....   | <b>R05</b>      |
| Heavy-Duty Radiator and<br>Transmission Oil Cooler .....  | <b>V02</b> | Off-Road Chassis Package (K1500 only)<br>(includes Bilstein 46mm shocks<br>and skid plate NZZ) .....   | <b>Z71</b> | Windows, Sliding Rear .....  | <b>A28</b>      |
| Defogger, Rear Windows<br>(Extended and Crew Cab Only) .....  | <b>C49</b> | Paint, Exterior  |            | Windows, Swing-Out Quarter<br>(Extended Cab) .....   | <b>A20</b>      |
| Emission Systems  |            | Solid .....  | <b>ZY1</b> | Work Truck Package .....   | <b>VLA</b>      |
| Standard .....  | <b>NA5</b> | Conventional Two-Tone .....  | <b>ZY2</b> |  |                 |
| High Altitude .....   | <b>NA6</b> | Deluxe Two-Tone .....  | <b>ZY4</b> |  |                 |
| California .....  | <b>YF5</b> | Pick-up Box Delete .....   | <b>ZW9</b> |  |                 |
| Engines:  |            | Radio Equipment:   |            |  |                 |
| 4.3L V6 EFI .....   | <b>LB4</b> | Radio Delete .....   | <b>UL5</b> |  |                 |
| 5.0L V8 EFI .....   | <b>L03</b> |  |            |  |                 |
| 5.7L V8 EFI .....   | <b>L05</b> |  |            |  |                 |
| 7.4L V8 EFI .....   | <b>L19</b> |  |            |  |                 |
| 6.2L V8 Diesel .....  | <b>LH6</b> |  |            |  |                 |

**DIMENSIONS**

| MODEL                                     | C/K 1500 PICKUP<br>REG. CAB/EXT. CAB<br>SPORTSIDE/FLEETSIDE |                        |       | C/K2500 PICKUP<br>REG. CAB/EXT. CAB<br>FLEETSIDE |                        | C/K3500 PICKUP<br>REG. CAB/ EXT.<br>CAB FLEETSIDE |               | C/K 3500 PICKUP<br>CREW CAB |          |
|---|---|------------------------|-------|--|------------------------|---|---------------|-----------------------------|----------|
|   | C/K 10703<br>C/K 10753                                      | C/K 10903<br>C/K 10953 |       | C/K 20753  | C/K 20903<br>C/K 20953 | C/K 30903<br>C/K 30953                            |               | C/K 30943                   |          |
| MODEL NUMBER                              | E62   | E63                    | E63   |  | C6P                    | C6U<br>& C6W                                      | C7A<br>(OPT.) | R04                         | R05      |
| <b>EXTERIOR DIMENSIONS</b>                |   |                        |       |  |                        |   |               |                             |          |
| <b>BODY</b>                               |   |                        |       |  |                        |   |               |                             |          |
| Wheelbase (in.)                           |   |                        |       |  |                        |   |               |                             |          |
| Reg. Cab                                  | 117.5   |                        | 131.5 | —  |                        | 131.5   | 131.5         | 168.5                       |          |
| Ext. Cab                                  | 141.5   |                        | 155.5 | 141.5  |                        | 155.5   | 155.5         | —                           |          |
| Overall Length (in.) w/o<br>Rear Bumper   |   |                        |       |  |                        |   |               |                             |          |
| Reg. Cab                                  | 194.1   |                        | 212.6 | —  |                        | 212.6   | 212.6         | 255.4                       |          |
| Ext. Cab                                  | 218.0   |                        | 237.0 | 218.0  |                        | 237.0   | 237.0         | —                           |          |
| Overall Height (in.)                      |   |                        |       |  |                        |   |               |                             |          |
| Nominal - Reg. Cab                        | 2WD 70.4  |                        |       | —  | 2WD 73.0               | 2WD 75.5  | 2WD 75.5      | 2WD 71.7                    | 2WD 70.8 |
|   | 4WD 73.8  |                        |       | —  | 2WD 74.3               | 4WD 75.8  | 4WD 75.8      | 4WD 71.7                    | 4WD 70.8 |
| Nominal - Ext. Cab                        | 2WD 70.6  |                        |       | 2WD 74.0   | 2WD 74.0               | 2WD 75.6  | 2WD 75.6      | —                           | —        |
|   | 4WD 73.6  |                        |       | 4WD 74.4   | 4WD 74.4               | 4WD 75.8  | 4WD 75.8      | —                           | —        |
| Maximum Width (in.)                       | 77.1  | 76.8                   | 76.8  | 76.8   | 76.8                   | 76.8  | 94.2          | 76.8                        | 94.2     |
| Bumper To Axle (in.)                      |   |                        |       |  |                        |   |               |                             |          |
| Front                                     | 34.9  |                        | 34.9  | 34.9   |                        | 34.9  |               | 34.9                        |          |
| Rear Overhang<br>(w/o bumper)             | 47.3  |                        | 52.2  | 47.3   |                        | 52.2  | 52.2          | 46.5                        |          |
| Cab Axle (in.)                            | 42.0  |                        | 56.0  | 41.8   |                        | 56.0  | 56.0          | 55.9                        |          |
| Cab to End of Frame (in.)                 | 78.7  |                        | 97.6  | 78.7   |                        | 97.6  | 97.6          | 97.0                        |          |
| Bumper to Back of Cab (in.)               |   |                        |       |  |                        |   |               |                             |          |
| Reg. Cab                                  | 110.6   |                        |       | —  |                        | 110.6   | 110.6         | 147.6                       |          |
| Ext. Cab                                  | 134.6   |                        |       | 134.6  |                        | 134.6   | 134.6         | —                           |          |
| Ground to Top of<br>Rear Load Floor (in.) | 2WD 29.0  |                        |       | 2WD 31.6   | 2WD 31.6               | 2WD 34.2  | 2WD 34.0      | 2WD 29.9                    | 2WD 29.2 |
|   | 4WD 32.4  |                        |       | 4WD 32.9   | 4WD 32.9               | 4WD 34.4  | 4WD 34.4      | 4WD 29.9                    | 4WD 29.2 |
| Ground Clearance (in.)                    |   |                        |       |  |                        |   |               |                             |          |
| Front/Rear                                |   |                        |       |  |                        |   |               |                             |          |
| Reg. Cab                                  | 2WD 7.0/8.4   |                        |       | —  | 2WD 7.8/7.8            | 2WD 8.4/8.1                                       | 2WD 7.9/7.6   | 8.0/7.7                     |          |
|   | 4WD 8.6/9.0   |                        |       | —  | 4WD 8.7/7.7            | 4WD 7.8/8.1                                       | 4WD 7.2/7.4   | 8.0/7.7                     |          |
| Ext. Cab                                  | 2WD 7.2/7.1   |                        |       | 2WD 7.9/7.7                                      | 2WD 7.9/7.7            | 2WD 8.4/8.0                                       | 2WD 7.9/7.6   | —                           |          |
|   | 4WD 9.2/9.6   |                        |       | 4WD 9.2/8.2                                      | 4WD 9.2/8.1            | 4WD 9.2/8.1                                       | 4WD 7.2/7.4   | —                           |          |
| <b>CARGO BOX</b>                          |   |                        |       |  |                        |   |               |                             |          |
| Inside Length at Floor (in.)              | 78.7  |                        | 97.6  | 78.6   |                        | 97.6  | 97.6          | 96.1                        |          |
| Inside Width at Top (in.) Rear            | 49.1  | 61.9                   | 61.9  | 61.9   |                        | 61.9  | 61.9          | 65.0                        |          |
| Inside Width at Floor (in.)               | 49.1  | 64.7                   | 64.7  | 64.7   |                        | 64.7  | 64.7          | 64.8                        |          |
| Inside Width at<br>Wheelhousing (in.)     | 49.1  |                        |       | 49.1   |                        | 49.1  | 49.1          | 49.1                        |          |
| Inside Height (in.)                       | 19.3  |                        |       | 19.3   |                        | 19.3  | 19.3          | 19.2                        |          |
| Tailgate Width (in.) (Top)                | 50.9  | 62.0                   | 62.0  | 62.0   |                        | 62.0  | 62.0          | 62.0                        |          |
| <b>SIGN PANEL AREA (in.)</b>              |   |                        |       |  |                        |   |               |                             |          |
| Reg. Cab                                  | 17 x 48 3/4   |                        |       | 17 x 48 3/4                                      |                        | 17 x 48 3/4                                       | 17 x 48 3/4   | —                           |          |
| Ext. Cab                                  | 17 x 77 1/2   |                        |       | 17 x 77 1/2                                      |                        | 17 x 77 1/2                                       | 17 x 77 1/2   | —                           |          |
| Crew Cab                                  | —   |                        |       | —  |                        | —   | —             | 17 x 85 3/4                 |          |

**INTERIOR DIMENSIONS**

| <b>CAB</b>  |        |  |        |        |           |
|---|--------|--|--------|--------|-----------|
| Headroom (in.) Front/Rear                           | 40.0/— |  | 40.0/— | 40.0/— | 40.1/40.8 |
| Legroom (in.) Front/Rear                            | 41.7/— |  | 41.7/— | 41.7/— | 41.8/39.2 |
| Shoulder Room (in.)<br>Front/Rear                   | 66.0/— |  | 66.0/— | 66.0/— | 66.0/66.1 |
| Hip Room (in.) Front/Rear                           | 60.7/— |  | 60.7/— | 60.7/— | 60.5/59.6 |
| Ext. Cab<br>Cargo Volume (cu. ft.)<br>w/o Rear Seat | 40.5   |  | 40.5   | 40.5   | —         |

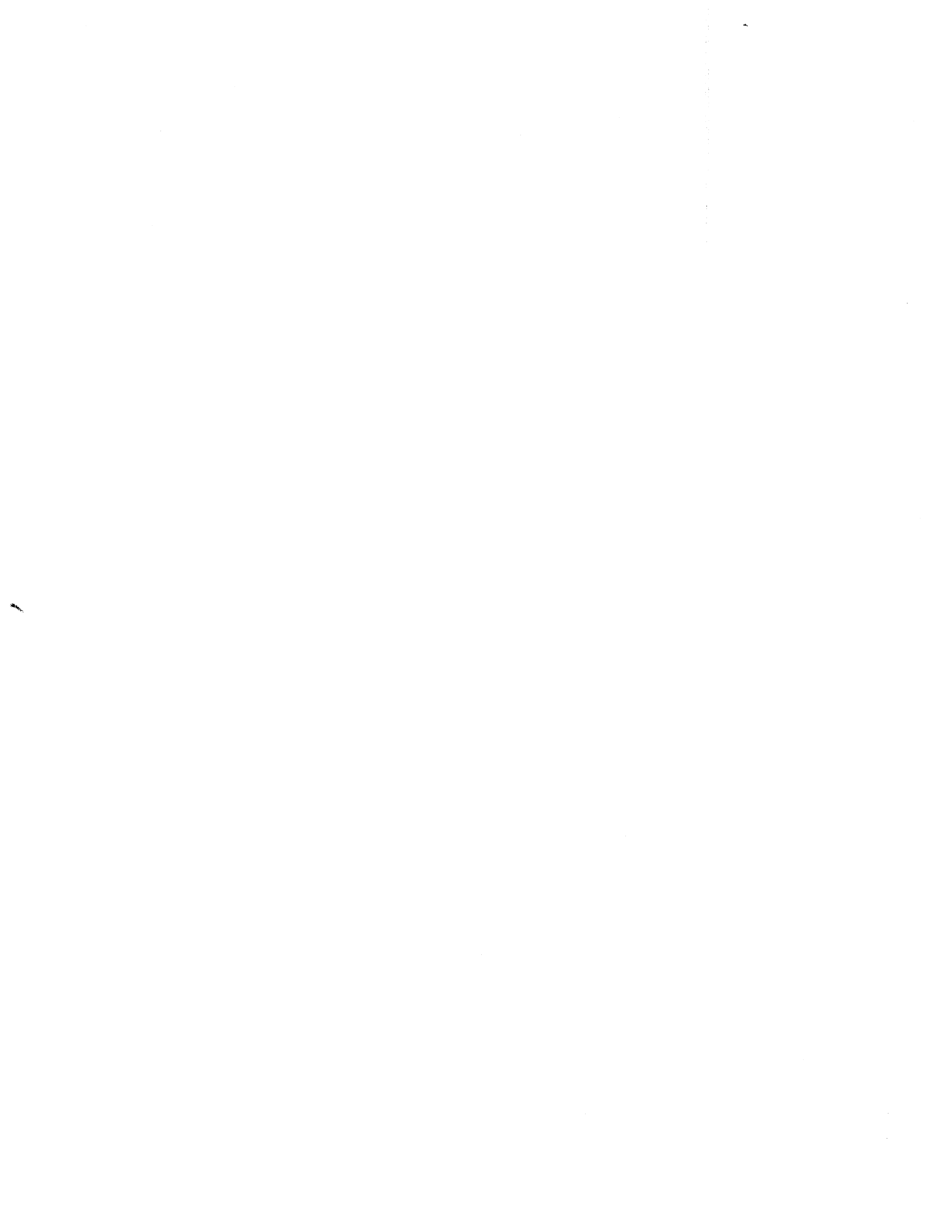



# 1993 CHEVROLET ALTERNATOR CURVES

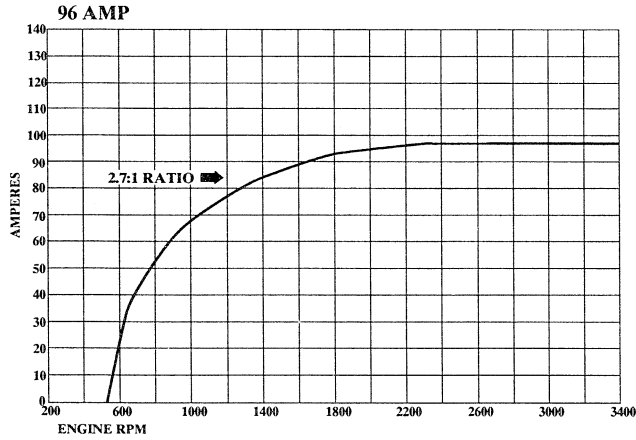

S-10 PICKUP (w/2.5L engine)

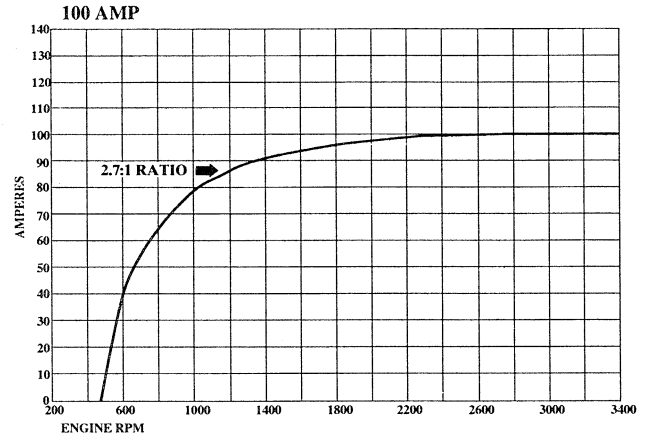

APV LUMINA  
S-10 PICKUP (w/2.8L engine)

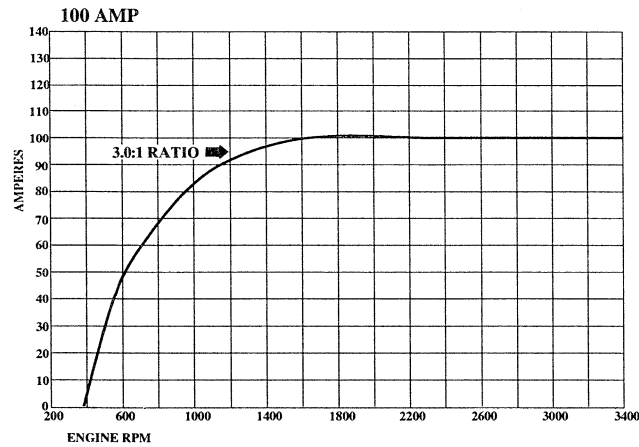

C/K PICKUP (w/diesel engine)  
C/K CREW CAB (w/diesel engine)  
C/K CHASSIS-CAB (w/diesel engine)  
3500-HD (w/diesel engine)  
SPORTVAN (w/diesel engine)  
CHEVY VAN (w/diesel engine)  
G-CUTAWAY/HI-CUBE (w/diesel engine)

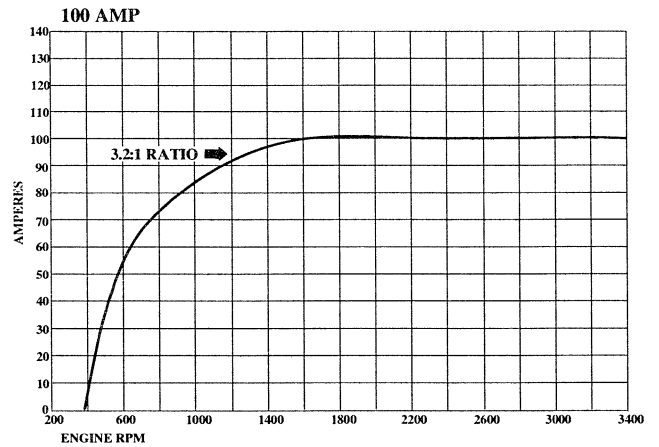

S-10 PICKUP  
C/K PICKUP  
C/K CREW CAB  
C/K CHASSIS-CAB  
3500-HD  
S-BLAZER  
BLAZER  
SUBURBAN  
ASTRO PASSNEGER  
SPORTVAN  
ASTRO CARGO  
CHEVY VAN  
G-CUTAWAY/HI-CUBE

# 1993 CHEVROLET ALTERNATOR CURVES

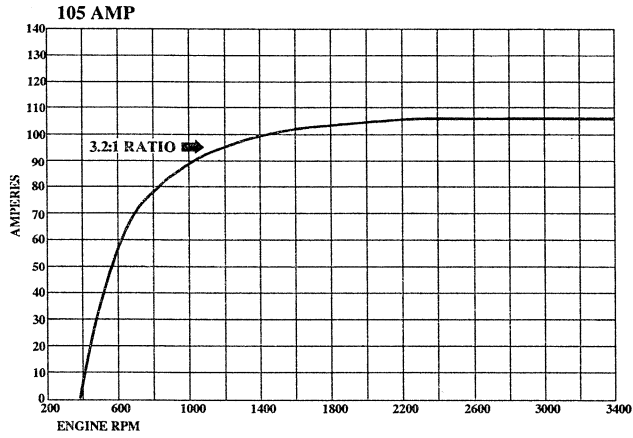

SUBURBAN\*  
 ASTRO PASSENGER\*  
 APV LUMINA (w/3.8L engine)  
 SPORTVAN\*  
 CHEVY VAN\*  
 G-CUTAWAY/HI-CUBE\*  
 F.C. CHASSIS/STEP-VAN  
 MOTOR HOME CHASSIS  
 P-30

\* This alternator is available only as part of an RPO

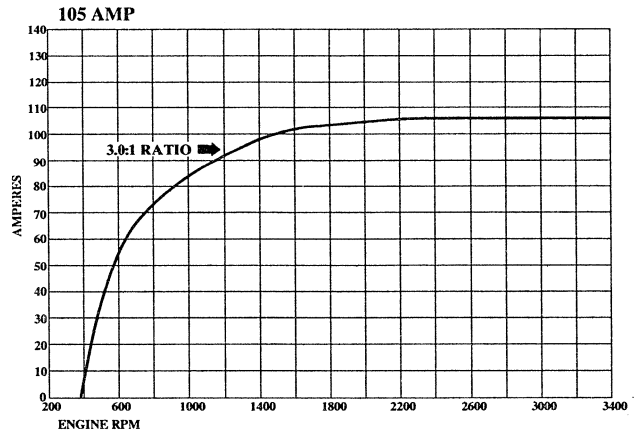

MOTOR HOME CHASSIS (w/diesel engine)  
 CHEVY VAN\* (w/diesel engine)  
 SPORTVAN\* (w/diesel engine)

\* This alternator is available only as part of an RPO

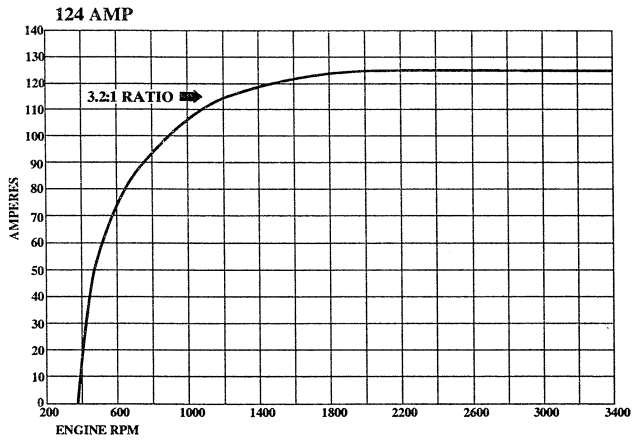

F.C. CHASSIS/STEP-VAN\*  
 MOTOR HOME CHASSIS (Reqs. 7.4L engine)  
 P-30 (Reqs. 7.4L engine)

\* This alternator is available only as part of an RPO

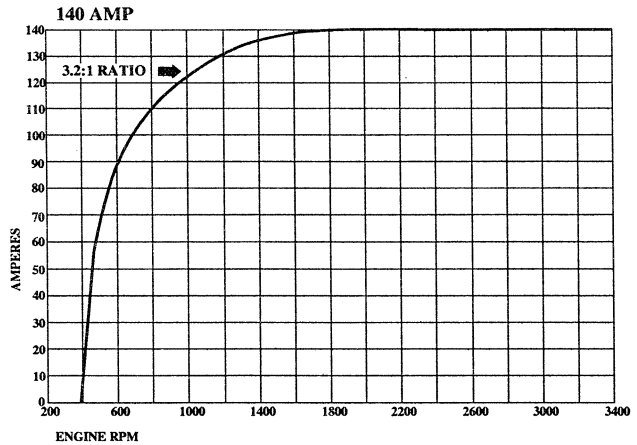

APV LUMINA

\* This alternator is available only as part of an RPO



CHEVROLET MOTOR DIVISION  
30007 VAN DYKE AVENUE  
WARREN, MICHIGAN 48090



GMC TRUCK DIVISION  
31 JUDSON STREET  
PONTIAC, MICHIGAN 48342-2230



## TRUCK – CAMPER LOADING

### CALCULATIONS TO DETERMINE FORWARD (A) AND REARWARD (B) LOCATION OF CENTER OF GRAVITY FOR CARGO WEIGHT RATING

#### Calculations for Dimension A

$$A = \left\{ \frac{\text{Front GAWR} - 1.05 \times \text{Front Weight}^* \text{ of Truck}}{\text{Cargo Weight Rating}} \right\} \times WB + C$$

Enter Front GAWR ..... \_\_\_\_\_

Subtract Front Weight\* of Truck X 1.05 ..... -(\_\_\_\_\_)

Answer ..... \_\_\_\_\_

Divide Answer by Cargo Weight Rating (CWR) ..... + \_\_\_\_\_

Answer ..... \_\_\_\_\_

Multiply Answer by Wheelbase ..... X \_\_\_\_\_

(See Chart on Page 10)

Answer ..... \_\_\_\_\_

Add C Dimension to Answer ..... +C \_\_\_\_\_

(See Chart on Page 10)

Dimension A = \_\_\_\_\_

Note: If "A" is greater than pickup box length, use box length for "A" dimension.

#### Calculations for Dimension B

$$B = \left\{ 1 - \frac{\text{Rear GAWR} - 1.1 \times \text{Rear Weight}^* \text{ of Truck}}{\text{Cargo Weight Rating}} \right\} \times WB + C$$

Enter Rear GAWR ..... \_\_\_\_\_

Subtract Rear Weight\* of Truck X 1.1 ..... -(\_\_\_\_\_)

Answer ..... \_\_\_\_\_

Divide Answer by Cargo Weight Rating (CWR) ..... - \_\_\_\_\_

Answer ..... \_\_\_\_\_

Subtract Answer from 1.000 ..... -(\_\_\_\_\_)

Multiply Answer by Wheelbase ..... X \_\_\_\_\_

Answer ..... \_\_\_\_\_

Add C Dimension to Answer ..... +C \_\_\_\_\_

Dimension B = \_\_\_\_\_

Note: If "B" dimension is negative, use 0 (zero) for "B" dimension.

If "B" dimension is greater than "A" dimension, camper usage is not recommended at the Calculated Cargo Weight Rating. Camper usage may be possible for a lighter camper. Substitute known specific camper weight (less than Cargo Weight Rating) for Cargo Weight Rating in calculations above to determine "A" to "B" range for that specific camper.

**Record dimension A and B on page 3.**

\*From page 7 line 4a.

# TRUCK – CAMPER LOADING

## MODEL CODES AND DIMENSIONS

| SERIES | MODEL NUMBER | PICKUP BOX LENGTH | PICKUP STYLE | WB | "C"* |
|--------|--------------|-------------------|--------------|----|------|
|--------|--------------|-------------------|--------------|----|------|

### REGULAR CAB MODELS

|           |          |     |                          |        |        |
|-----------|----------|-----|--------------------------|--------|--------|
| S/T-10/15 | S/T10803 | 7½' | Fleetside/Wideside (E63) | 117.9" | 42.40" |
| C/K1500   | C/K10703 | 6½' | Fleetside/Wideside (E63) | 117.5" | 38.70" |
|           |          |     | Sportside (E62)          | 117.5" | 38.61" |
|           | C/K10903 | 8'  | Fleetside/Wideside (E63) | 131.5" | 43.57" |
| C/K2500   | C/K20903 | 8'  | Fleetside/Wideside (E63) | 131.5" | 43.57" |
| C/K3500   | C/K30903 | 8'  | Fleetside/Wideside (E63) | 131.5" | 43.57" |

### EXTENDED/CLUB CAB MODELS

|         |          |     |                          |        |        |
|---------|----------|-----|--------------------------|--------|--------|
| C/K1500 | C/K10753 | 6½' | Fleetside/Wideside (E63) | 141.5" | 38.70" |
|         |          |     | Sportside (E62)          | 141.5" | 38.61" |
|         | C/K10953 | 8'  | Fleetside/Wideside (E63) | 155.5" | 43.57" |
| C/K2500 | C/K20753 | 6½' | Fleetside/Wideside (E63) | 141.5" | 38.70" |
|         |          |     | Sportside (E62)          | 141.5" | 38.61" |
|         | C/K20953 | 8'  | Fleetside/Wideside (E63) | 155.5" | 43.57" |
| C/K3500 | C/K30953 | 8'  | Fleetside/Wideside (E63) | 155.5" | 43.57" |

### CREW CAB MODEL

|         |          |    |                          |        |        |
|---------|----------|----|--------------------------|--------|--------|
| C/K3500 | C/K30943 | 8' | Fleetside/Wideside (E63) | 168.5" | 43.57" |
|---------|----------|----|--------------------------|--------|--------|

\*Dimension "C" is the distance from the centerline of the rear axle to the end of the pickup box floor.  
Dimensions A and B can be calculated by using the formula on page 11.

REGULAR CAB S-10/15 PICKUPS

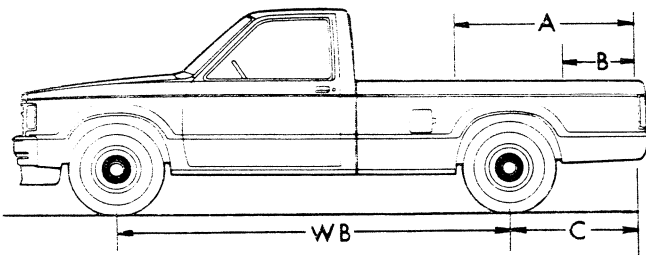

EXTENDED CAB C/K PICKUPS

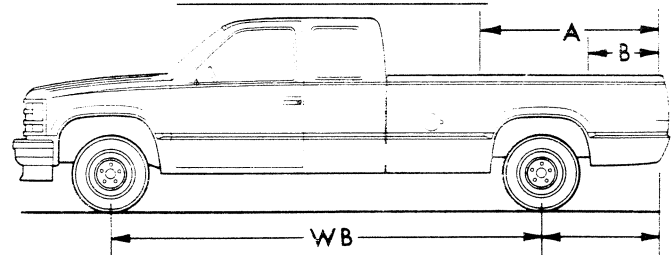

REGULAR CAB C/K PICKUPS

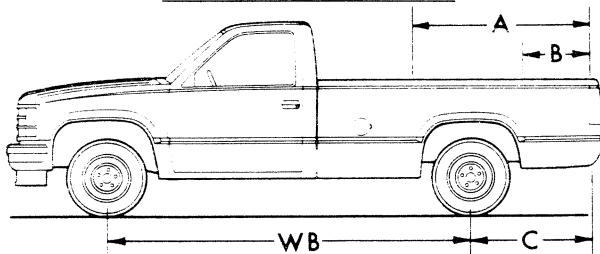

CREW CAB CK/PICKUPS

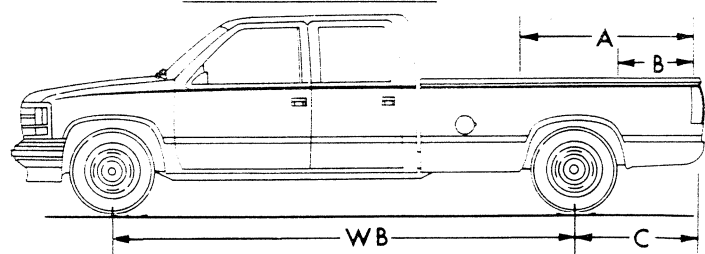

# TRUCK - CAMPER LOADING

## DIMENSIONS

### C/K PICKUPS

#### SPORTSIDE SHORT BOX

(MODELS C/K 10703, C/K 10753 [E62])

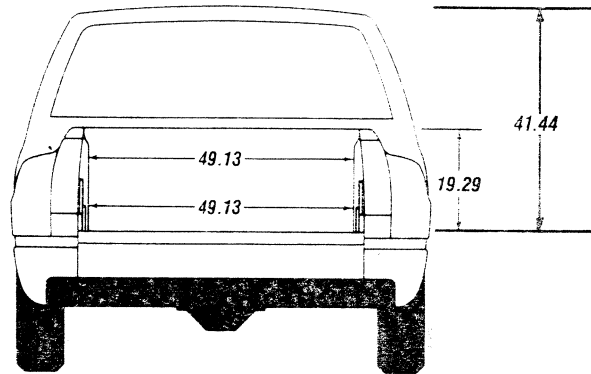
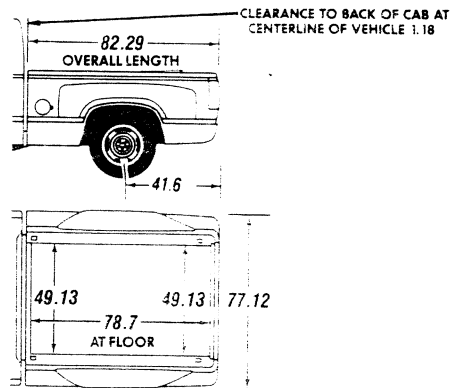

### C/K EXTENDED/CLUB CAB PICKUPS

#### FLEETSIDE/WIDESIDE

(MODELS C/K10753, C/K10953, C/K20753, C/K20953, C/K30953)

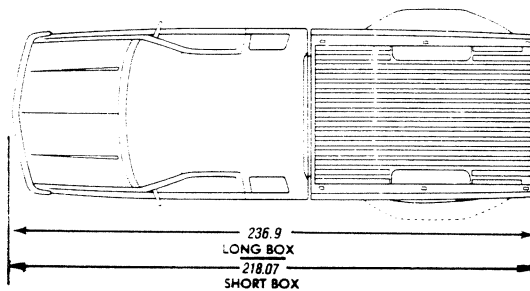
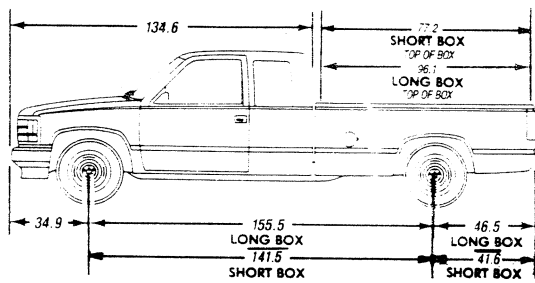

### C/K CREW CAB PICKUPS

#### FLEETSIDE/WIDESIDE LONG BOX

(MODELS C/K30943)

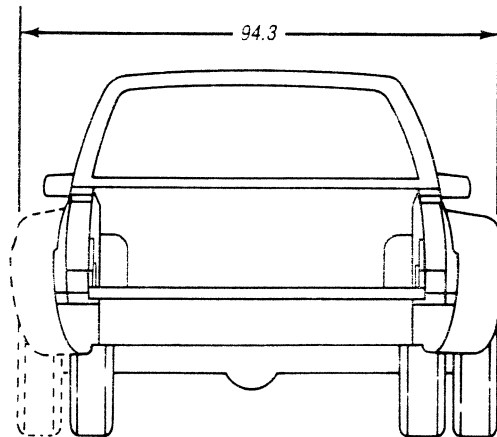
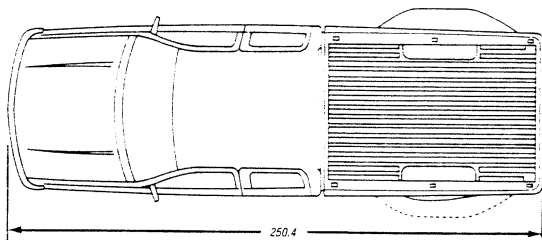
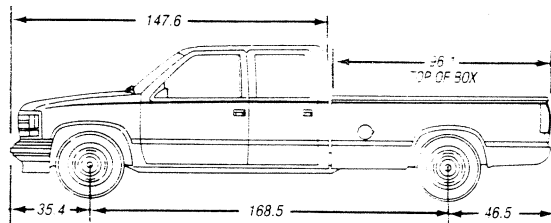

# TRUCK - CAMPER LOADING DIMENSIONS

## S-10/15 PICKUPS

### LONG BOX (MODEL S/T10803)

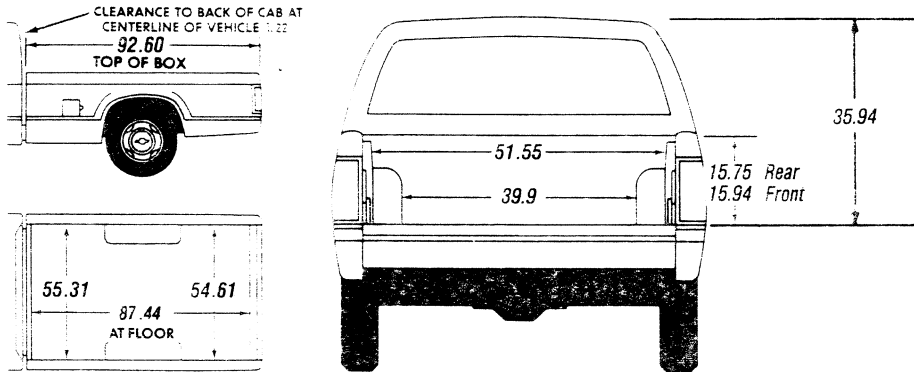

## C/K PICKUPS

### FLEETSIDE/WIDESIDE SHORT BOX (MODELS C/K10703, C/K10753, C/K20753)

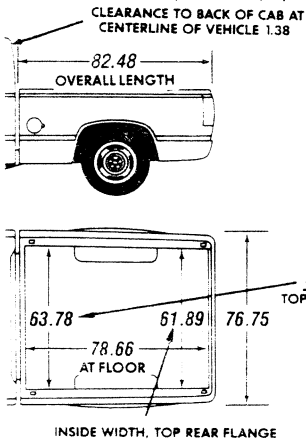

### FLEETSIDE/WIDESIDE LONG BOX (MODELS C/K10903, C/K20903, C/K30903, C/K10953, C/K20953, C/K30943, C/K30953)

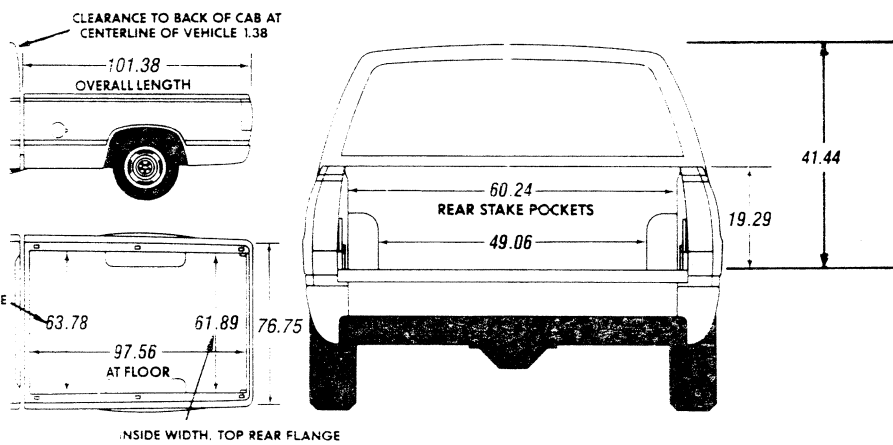

## C/K REGULAR CAB PICKUPS

(MODELS C/K10703)

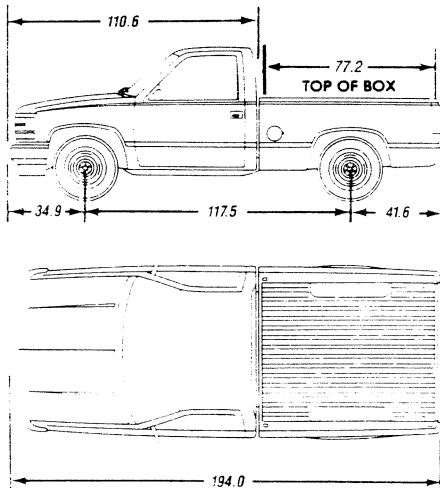

(MODELS C/K10903, C/K20903, C/K30903)

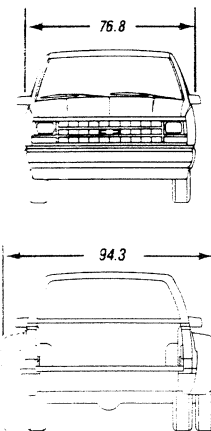
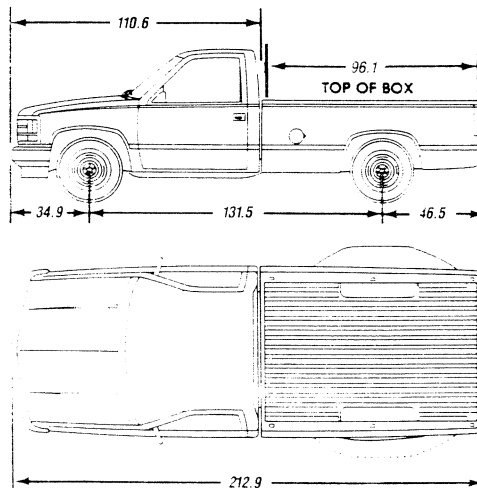

**TRUCK-CAMPER LOADING  
S/T PICKUPS, C/K PICKUPS,  
EXTENDED/CLUB AND CREW CAB PICKUPS  
WORKSHEET-CARGO WEIGHT RATING**

|  |             |                     |            |
|--|-------------|---------------------|------------|
| 1. <b>Model GVWR</b> _____                 | <b>GAWR</b> | FRONT _____         | REAR _____ |
| 2. <b>Curb Weights:</b>                    |             | FRONT _____         | REAR _____ |
| 3. <b>Passenger Weights:</b>               |             | FRONT _____         | REAR _____ |
| 4. <b>Other factory-installed options:</b> |             |                     |            |
| .....                                      |             | _____               | _____      |
| .....                                      |             | _____               | _____      |
| .....                                      |             | _____               | _____      |
| .....                                      |             | _____               | _____      |
| .....                                      |             | _____               | _____      |
| .....                                      |             | _____               | _____      |
| .....                                      |             | _____               | _____      |
| .....                                      |             | _____               | _____      |
| .....                                      |             | _____               | _____      |
| 4a.  |             | <b>TOTALS</b> _____ | _____      |

|  |           |       |
|--|-----------|-------|
| 5. <b>Front and Rear Weight:</b>                                 | _____     | _____ |
| 5a. <b>Vehicle sub-total weight</b> (add front and rear weight): |           | _____ |
| 5b. <b>Add 50 lbs. for all models*</b>                           |           | + 50. |
| 5c. <b>Adjusted total vehicle weight:</b>                        |           | _____ |
| 6. <b>Vehicle GVWR:</b>  | _____     |       |
| Adjusted total vehicle weight                                    | ( _____ ) |       |
| Cargo Weight Rating  | _____     |       |

**Record on page 3.**

\*If your vehicle is available, drive to a scale and weigh, with occupants, the front and the rear separately to determine the axle loads. You will then be able to use your actual cargo weight rating and not have to add the 50#



## **TRUCK – CAMPER LOADING**

### **S/T PICKUPS, C/K PICKUPS, EXTENDED/CLUB AND CREW CAB PICKUPS**

#### **INSTRUCTIONS FOR PROSPECTIVE TRUCK PURCHASERS** **VEHICLE SELECTION AND WEIGHT ANALYSIS**

i. For S/T-10/15 Models.

You must order S/T 10803 (117.9" WB) model with one of the following GVWR Ratings:

S10803 (2WD) 4600 lb. GVWR

S10803 (2WD) 4900 lb. GVWR

T10803 (4x4) 5150 lb. GVWR

if you intend to use a slide-in camper on your S/T-10/15 Pickup. Record the model on page 3. Record the model GVWR, front GAWR, and rear GAWR on page 7. These ratings can be found in the S/T-10/15 section of the General Motors Light-Duty Truck Facts/Data Book on the Specifications pages.

For C/K Models.

From the model selection pages of the C/K Pickup section of the General Motors Light-Duty Truck Facts/Data Book, select the pickup model you desire. Record this information on page 3. Refer to the Specification pages for the selected model. Select the GVWR you require and note any minimum tire size and chassis equipment requirements for that GVWR. (To approximate the GVWR you require, add your loaded camper weight to the vehicle curb weight plus the occupants weight shown on the appropriate weights pages of the Facts/Data Book.) Record this GVWR and the Gross Axle Weight Rating (GAWR), Front and Rear (from the Specifications pages), on line 1 of the camper loading worksheet, page 7.

2. Record the front and rear curb weights of your selected vehicle on line 2, page 7.
3. Record the front and rear passenger weights on line 3, page 7.
4. List all factory-installed options you desire, including any options required by your selected GVWR, with their front and rear weights on the Pickup camper loading worksheet on page 7.
5. Total the front and rear weights of vehicle model and options to arrive at the total front and rear weight of the vehicle. Follow the directions on page 7, lines 5 through 5C to arrive at the adjusted total vehicle weight.
6. Subtract the adjusted total vehicle weight from the GVWR to arrive at the cargo weight rating (CWR) of your truck.\* Record this information on page 3.
7. Proceed to page 11 and calculate the center of gravity location limits using front and rear GAWRs, cargo weight rating (CWR), and front and rear weight of truck as determined above. Record this information on page 3.

\*The addition of any dealer-installed or other accessories will reduce the cargo-carrying capacity by the weight of the equipment installed.

# TRUCK – CAMPER LOADING

## DEFINITION OF TERMS

For the purposes of calculating Truck-Camper Loading in this book, listed below are some common terms and abbreviations:

**Cargo Weight Rating (CWR)**—means the value specified by the vehicle manufacturer as the cargo-carrying capacity of a vehicle in pounds, exclusive of (minus) the weight of occupants, computed as 150 pounds times the number of designated seating positions.

**Center of Gravity (CG)**—Point where the mass of a body is concentrated and if suspended at that point would balance front and rear.

**Curb Weight**—Weight of a vehicle without driver, passengers or cargo but including fuel, coolant and other items of standard equipment.

**Dimension A & B**—Front and rear limit of Center of Gravity (CG) zone.

**Gross Vehicle Weight Rating** or “GVWR” means the value specified by the manufacturer as the loaded weight of a single vehicle.

**Gross Axle Weight Rating** or “GAWR” means the value specified by the vehicle manufacturer as the load carrying capacity of a single axle system measured at the tire-ground interfaces.

**Model Weight**—Weight of the vehicle with all items of standard equipment, 150 pounds per passenger in each designated seating position and maximum capacity of fuel, oil and coolant.

**Payload Rating**—is the maximum allowable load (including the weight of the driver and all occupants) that the vehicle can carry based on all factory-installed equipment on the vehicle.

**RPO**—Regular Production Option.

**Slide-in Camper**—means a camper having a roof, floor, and sides, designed to be mounted on and removable from the cargo area of a truck by the user.

**Weight Distribution**—The amount of a vehicles weight that rests on each axle.

**Wheelbase (WB)**—The distance from the centerline of the front axle to the centerline of the rear axle.

---

## LIMITATIONS

---

The following General Motors truck models are not recommended for slide-in camper applications:

- Any pickup model with a cargo weight rating (CWR) of less than 500 lbs. A statement to this effect is imprinted on the Truck-Camper Loading information label which states whether that vehicle is recommended for use with a slide-in camper.
- S-10/15 (2WD) Pickup with 4200 lb. GVWR.
- T-10/15 (4x4) Pickup with 4650 lb. GVWR.
- S/T-10/15 Pickup with 108.3” WB.
- S/T-10/15 Extended Cab Pickup.

**Note:** C/K 1500 Pickups should not be used for larger, cab-over type slide-in campers.

## TRUCK – CAMPER LOADING

**Loading Instructions**—When the truck is used to carry a slide-in camper, the total cargo load of the truck consists of the manufacturer's camper weight figure, the weight of installed additional camper equipment not included in the camper manufacturer's weight figure, the weight of camper cargo, and the weight of passengers *in the camper*. The total cargo load should not exceed the truck's cargo weight rating (CWR) and the camper's center of gravity should fall within the truck's recommended center of gravity zone when installed.

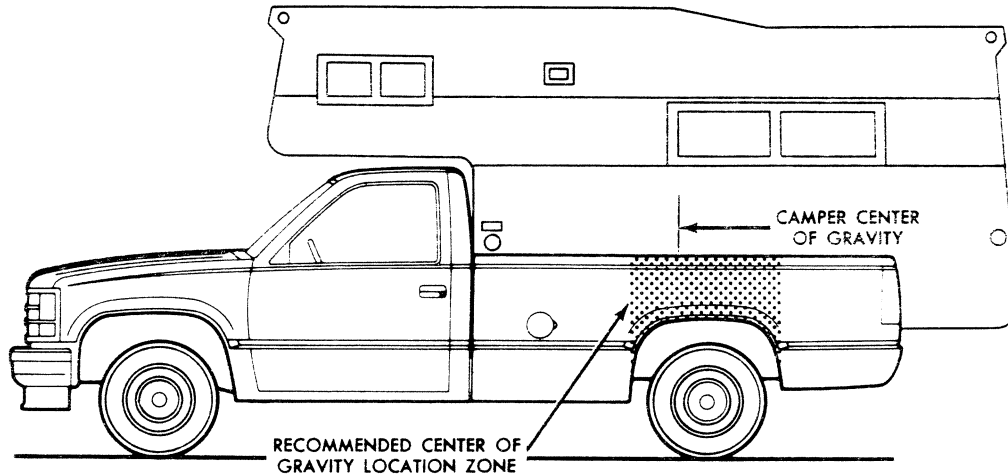

Any accessories or other equipment added to this vehicle, after final date of manufacture, must be weighed or have their weight determined, and the weight deducted from the prescribed cargo weight rating (CWR) of this vehicle. This may decrease the permissible longitudinal zone of the center of gravity for this vehicle.

The longitudinal center of gravity zone has been determined for the full cargo weight rating of this truck. If a slide-in camper has a total weight less than the cargo weight rating (CWR), the permissible longitudinal zone of the center of gravity may be larger. However, individual axle loads should not exceed either of the gross axle weight ratings (GAWR).

Secure loose items to prevent weight shifts that could affect the balance of your vehicle. When the truck camper is loaded, drive to a scale and weigh the front and the rear separately to determine the axle loads. Individual axle loads should not exceed either of the gross axle weight ratings (GAWR). The total of the axle loads should not exceed the gross vehicle weight rating (GVWR). These ratings are given on the vehicle identification plate and on the vehicle certification label which are located on the left side of the vehicle, normally on the door latch post or door edge next to the driver. If weight ratings are exceeded, move or remove items to bring all weights below the ratings.

**CAUTION:** The longitudinal center of gravity is only one of the many factors which may affect the overall performance of a vehicle, including handling, steering and braking. The cargo load should be distributed on both sides of the centerline as equally as possible. The recommended longitudinal limits for the camper's center of gravity are based on the assumption that the vehicle will be operated with reasonable prudence in light of all of the existing conditions. Failure to do so could result in unsatisfactory vehicle performance and could make the vehicle unsafe to operate.

In this connection, refer to any recommendations by the slide-in camper manufacturer regarding installation and loading of the camper.

## TRUCK – CAMPER LOADING

Consumer Information Regulation 575.103 requires manufacturers of trucks capable of accommodating slide-in campers to specify the vehicles' Cargo Weight Rating (CWR) and the longitudinal limits within which the center of gravity for the cargo weight rating should be located.

**Cargo Weight Rating (CWR)**—The cargo weight rating of a vehicle means the value specified by the vehicle manufacturer as the cargo-carrying capacity of a vehicle in pounds, exclusive of (minus) the weight of occupants, computed as 150 pounds times the number of designated seating positions.

**Longitudinal Center of Gravity (CG) Zone for CWR**—The forward limit of the recommended CG Zone is determined by the application of dimension "A" measured in inches from the rear of the truck bed. The rearward limit of the recommended CG Zone is established by application of dimension "B", also measured in inches from the rear of the truck bed. The recommended CG Zone lies between these points.

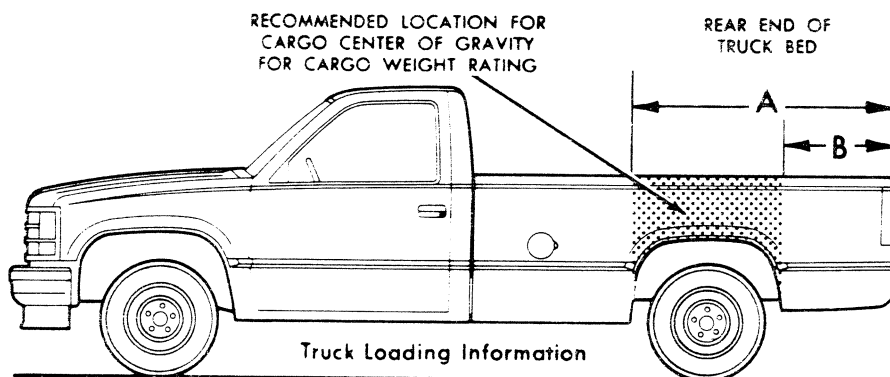

Model \_\_\_\_\_ Calculated Cargo Weight Rating \_\_\_\_\_

Dimension A \_\_\_\_\_ Dimension B \_\_\_\_\_

### Limitations on Recommended CG Zones

#### FORWARD LIMIT

- (1) Must not extend beyond the inside surface of the pickup box.      (2) Must not exceed the front gross axle weight rating (GAWR).

#### REARWARD LIMIT

- (1) Must be no farther rearward than the inside surface of the pickup box.      (2) Must not exceed the gross axle weight rating (GAWR) of the rear axle.  
 (2) Must not exceed the gross axle weight below:      (3) Must not exceed rear axle load limits below:

| Series                 | Rear Axle Load Limits<br>(% of GVWR) |
|------------------------|--------------------------------------|
| S/T-10/15              | 62%                                  |
| C/K 1500               | 60%                                  |
| C/K 2500               | 65%                                  |
| C/K 2500/C6P, C/K 3500 | 70%                                  |

**Vehicle CG Identification**—All General Motors Corporation trucks that may be suitable for carrying a slide-in camper incorporate a Truck-Camper Loading information label located on the glove box floor on C/K and S/T-10/15 models. The vehicle identification number (VIN), the as-manufactured cargo weight rating (CWR) of that vehicle plus the CG limits of dimension "A" and "B" for that vehicle in inches are included.

Vehicle and Truck-Camper Loading are also discussed at length in the Vehicle Owner's Manual.

# 1993 GENERAL MOTORS TRUCKS

## **Consumer Information**

### **Truck – Camper Loading**

CONSUMER INFORMATION REGULATION 575.103 issued by the National Highway Traffic Safety Administration requires manufacturers of trucks capable of accommodating slide-in camper bodies to provide information concerning proper load and proper load distribution in truck-camper applications.

This Consumer Information booklet is designed to provide basic information relating to load capabilities of 1993 General Motors truck models which are adaptable to slide-in camper applications. Information contained herein is applicable to the truck buyer who already owns a 1993 General Motors truck or to a prospective truck purchaser.

The Regulation also provides that proper truck-camper loading information is to be maintained in truck dealerships and be made available to all prospects on request. This booklet relates to the 1993 General Motors truck models recommended for slide-in camper applications and is to be used as a consumer information piece.

Product specifications or data contained herein may change periodically. When a revision of this booklet is supplied to truck dealers, it is the dealers' responsibility to make the revised information available to the public.

Chevrolet's 1988 and newer Full-Size C/K Pickups feature new styling that is more aerodynamic than prior models. Aftermarket manufacturers offer many products, such as slide-in campers, camper shells, and bedliners, designed to fit on the new pickups. However, some products designed for use on Chevrolet Full-Size Pickups, built prior to the 1988 model year or R-V models through the 1991 model year, may not fit in the bed of this new vehicle. Please confirm the compatibility of any aftermarket product you intend to install on your new truck by consulting the product manufacturer.

---

All illustrations and specifications contained in this literature are based on the latest product information available at the time of publication approval. The right is reserved to make changes at any time in prices, colors, materials, equipment, specifications and models, and also to discontinue models.

---

# 1993 GENERAL MOTORS CORPORATION

INFORMATION REGARDING

# CONSUMER INFORMATION TRUCK-CAMPER LOADING

PUBLISHED MARCH 1992



CHEVROLET MOTOR DIVISION  
30007 VAN DYKE AVENUE  
WARREN, MICHIGAN 48090



GMC TRUCK DIVISION  
31 JUDSON STREET  
PONTIAC, MICHIGAN 48342-2230



**C/K 1500 REGULAR CAB PICKUP  
INTERIOR AND EXTERIOR COLOR AVAILABILITY CHART  
WITH ZY1, ZY2 AND ZY4 PAINT SCHEMES  
(ZY4 N/A w/E62 BODY CODE)**

PLEASE NOTE: Below are the interior trim color and exterior paint combinations recommended by Chevrolet. They are the only available interior and exterior combinations allowed.

| TRIM LEVEL<br>Seat Type                       | Decor | INTERIOR COLORS |      |        |      |
|---|-------|-----------------|------|--------|------|
|   |       | Beige           | Blue | Garnet | Gray |
| <b>CHEYENNE</b>                               | Std.  |                 |      |        |      |
| Vinyl Bench Seat                              |       | VUU1            | VDD1 | VRR1   | VQQ1 |
| Cloth Bench Seat                              |       | CUU1            | CDD1 | CRR1   | CQQ1 |
| Vinyl Reclining Low Back Bucket Seats         |       | VUU2            | VDD2 | VRR2   | VQQ2 |
| Cloth Reclining Low Back Bucket Seats         | CUU2  | CDD2            | CRR2 | CQQ2   |      |
| <b>SILVERADO</b>                              | YE9   |                 |      |        |      |
| Custom Vinyl Bench Seat                       |       | XUU1            | XDD1 | XRR1   | XQQ1 |
| Custom Cloth Bench Seat                       |       | LUU1            | LDD1 | LRR1   | LQQ1 |
| Custom Vinyl Reclining Split Bench Seat       |       | XUU3            | XDD3 | XRR3   | XQQ3 |
| Custom Cloth Reclining Split Bench Seat       |       | LUU3            | LDD3 | LRR3   | LQQ3 |
| Custom Vinyl Reclining Low Back Bucket Seats  |       | XUU2            | XDD2 | XRR2   | XQQ2 |
| Custom Cloth Reclining High Back Bucket Seats | LUU6  | LDD6            | LRR6 | LQQ6   |      |

| EXTERIOR COLORS             | Color Code 1 | Color Code 2 | INTERIOR & EXTERIOR COMBINATIONS SHOWN ARE THE ONLY COMBINATIONS AVAILABLE |   |   |   | STRIPE COLORS w/ZY4 PAINT SCHEME |
|-----------------------------|--------------|--------------|--|---|---|---|----------------------------------|
|                             |              |              |  |   |   |   |                                  |
| BEIGE, SAND (Metallic)      | 57           | 57           | x  |   |   |   | N/A                              |
| * Black, Onyx               | 57           | 41           | x  |   |   |   | N/A                              |
| BLACK, ONYX                 | 41           | 41           | x  |   | x | x | N/A                              |
| Beige, Sand (Met)           | 41           | 57           | x  |   |   |   | Gold/Black                       |
| Quicksilver (Met)           | 41           | 96           |  |   |   | x | Sport Red/Silver                 |
| Red, Victory                | 41           | 74           |  |   | x | x | Silver/Victory Red               |
| Slate (Met)                 | 41           | 97           |  |   | x | x | Sport Red/Silver                 |
| BLUE, INDIGO (Metallic)     | 39           | 39           | x  | x |   | x | N/A                              |
| Beige, Sand (Met)           | 39           | 57           | x  | x |   |   | Gold/Black                       |
| Blue, Lt. Quasar (Met)      | 39           | 20           |  | x |   | x | Blue/Silver                      |
| Quicksilver (Met)           | 39           | 96           |  | x |   | x | Blue/Silver                      |
| BLUE, LT. QUASAR (Metallic) | 20           | 20           |  | x |   | x | N/A                              |
| Blue, Indigo (Met)          | 20           | 39           |  | x |   | x | Blue/Silver                      |
| Quicksilver (Met)           | 20           | 96           |  | x |   | x | Blue/Silver                      |
| White, Summit               | 20           | 50           |  | x |   | x | Blue/Silver                      |
| GREEN, TEAL (Metallic)      | 38           | 38           | x  |   |   | x | N/A                              |
| Beige, Sand (Met)           | 38           | 57           | x  |   |   |   | Gold/Black                       |
| Quicksilver (Met)           | 38           | 96           |  |   |   | x | Teal/Black                       |
| White, Summit               | 38           | 50           |  |   |   | x | Teal/Black                       |
| QUICKSILVER (Metallic)      | 96           | 96           |  | x | x | x | N/A                              |
| Black, Onyx                 | 96           | 41           |  |   | x | x | Sport Red/Silver                 |
| Blue, Indigo (Met)          | 96           | 39           |  | x |   | x | Blue/Silver                      |
| Blue, Lt. Quasar (Met)      | 96           | 20           |  | x |   | x | Blue/Silver                      |
| Green, Teal (Met)           | 96           | 38           |  |   |   | x | Teal/Black                       |
| Red, Dk. Garnet (Met)       | 96           | 84           |  |   | x | x | Gunmetal/Silver                  |
| Red, Victory                | 96           | 74           |  |   | x | x | Black/Silver                     |
| Slate (Met)                 | 96           | 97           |  |   | x | x | Sport Red/Silver                 |
| RED, DK. GARNET (Metallic)  | 84           | 84           | x  |   | x | x | N/A                              |
| Beige, Sand (Met)           | 84           | 57           | x  |   | x |   | Gold/Black                       |
| Quicksilver (Met)           | 84           | 96           |  |   | x | x | Gunmetal/Silver                  |
| RED, VICTORY                | 74           | 74           | x  |   | x | x | N/A                              |
| Black, Onyx                 | 74           | 41           |  |   | x | x | Silver/Victory Red               |
| Quicksilver (Met)           | 74           | 96           |  |   | x | x | Black/Silver                     |
| * Slate (Met)               | 74           | 97           |  |   | x | x | N/A                              |
| White, Summit               | 74           | 50           |  |   | x | x | Black/Silver                     |
| SLATE (Metallic)            | 97           | 97           |  |   | x | x | N/A                              |
| * Quicksilver (Met)         | 97           | 96           |  |   | x | x | N/A                              |
| * Red, Victory              | 97           | 74           |  |   | x | x | N/A                              |
| * White, Summit             | 97           | 50           |  |   | x | x | N/A                              |
| WHITE, SUMMIT               | 50           | 50           | x  | x | x | x | N/A                              |
| * Blue, Lt. Quasar (Met)    | 50           | 20           |  | x |   | x | N/A                              |
| * Green, Teal (Met)         | 50           | 38           |  |   |   | x | N/A                              |
| * Red, Victory              | 50           | 74           |  |   | x | x | N/A                              |
| * Slate (Met)               | 50           | 97           |  |   |   | x | N/A                              |

\*N/A w/ZY4 Paint

REVISED: 1-22-93

1993 ORDER GUIDE

C/K REGULAR CAB PICKUP

Page 3

Prices Shown Are Manufacturer's Suggested Retail Prices (MSRP) At The Time Of Publication. These Prices Are To Be Used Only As An Aid To Inventory Management Since MSRP Figures Change Periodically. The Vehicle Price Schedule Is The Official Pricing Documentation Of Chevrolet Motor Division And Should Be Used In Discussing Vehicle Prices With Potential Buyers. The Model Prices Shown In The Order Guide Include The Destination Freight Charges.



**C/K 1500 REGULAR CAB PICKUP  
PAINT APPLICATIONS  
WITH ZY1, ZY2 AND ZY4 PAINTSCHEMES  
(ZY4 N/A w/E62 BODY CODE)**

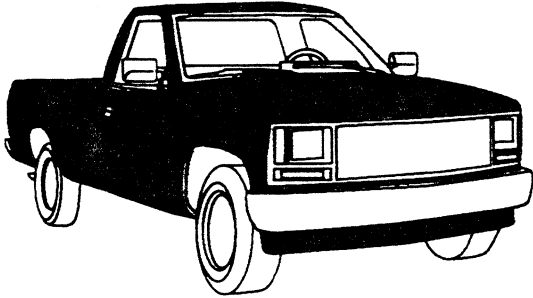

**SOLID PAINT - ZY1 (w/E63 Fleetside)**

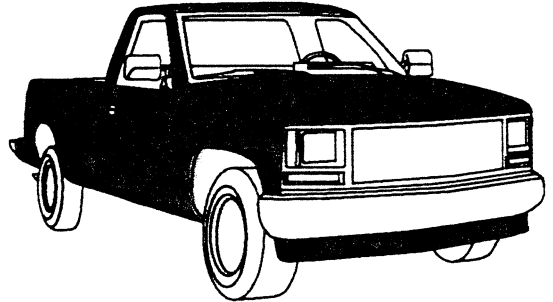

**SOLID PAINT - ZY1 (w/E62 Sportside)**

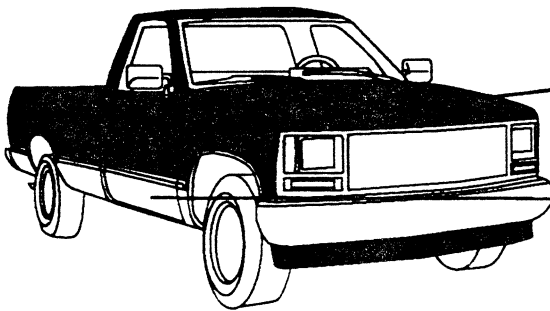

**CONVENTIONAL TWO-TONE PAINT-ZY2 (w/E63 Fleetside)**

COLOR CODE 1

COLOR CODE 2

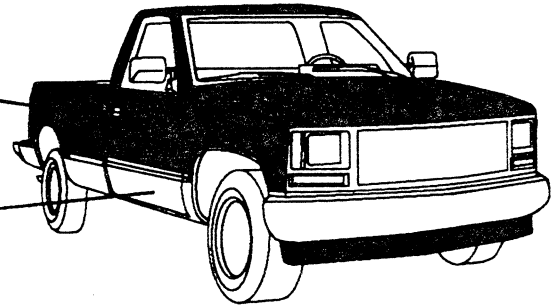

**CONVENTIONAL TWO-TONE PAINT-ZY2 (w/E62 Sportside)**

COLOR CODE 1

COLOR CODE 2

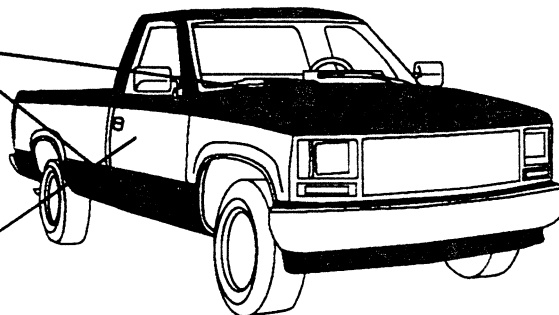

**DELUXE TWO-TONE PAINT - ZY4 (Reqs E63 Fleetside)**

**CUSTOM ORDERING OPTIONS**

PLEASE REVIEW OPTION RESTRICTIONS BEFORE ORDERING

| INCL<br>w/PEG | OPTION |   |
|---------------|--------|---|
|               |        | <b>TIRES - Continued</b>  |
|               |        | <b>K1500 Models Only</b>  |
| N.C.          | YHE    | LT225/75R16-C B/W Highway   |
| 72.00         | YHN    | LT225/75R16-C WOL On-Off Road   |
| 22.00         | YHJ    | LT225/75R16-C B/W On-Off Road   |
| 134.00        | YGL    | LT265/75R16-C B/W On-Off Road (K10903 w/LB4, L03 or LH6 Eng Reqs 3.73 Axle)<br>(K10703 w/LB4 or L03 Eng Reqs 3.73 Axle)   |
| 184.00        | YGM    | LT265/75R16-C WOL (K10903 w/LB4, L03 or LH6 Eng Reqs 3.73 Axle)<br>(K10703 w/LB4 or L03 Eng Reqs 3.73 Axle)   |
|               |        | <b>Spare</b>  |
|               |        | <b>C1500 Models Only</b>  |
| N.C.          | ZET    | P225/75R15 B/W Highway  |
| 25.00         | ZEV    | P225/75R15 W/L Highway  |
|               | ZFL    | P235/75R15 B/W Highway<br>w/Diesel Eng or R9A<br>w/o Diesel Eng or R9A  |
| N.C.          |        |   |
| 14.00         | ZFM    | P235/75R15 W/S Highway<br>w/Diesel Eng or R9A<br>w/o Diesel Eng or R9A  |
| 18.00         |        |   |
| 32.00         | ZFN    | P235/75R15 W/L Highway<br>w/Diesel Eng or R9A<br>w/o Diesel Eng or R9A  |
| 25.00         |        |   |
| 39.00         |        |   |
| N.C.          | ZCN    | P275/60R15 B/W Highway (Reqs ZQ8 Sport Chassis)   |
|               |        | <b>K1500 Models Only</b>  |
| N.C.          | ZHE    | LT225/75R16-C B/W Highway   |
| 36.00         | ZHN    | LT225/75R16-C WOL On-Off Road   |
| 11.00         | ZHJ    | LT225/75R16-C B/W On-Off Road   |
| 67.00         | ZGL    | LT265/75R16-C B/W On-Off Road (K10903 w/LB4, L03 or LH6 Eng Reqs 3.73 Axle)<br>(K10703 w/LB4 or L03 Eng Reqs 3.73 Axle)   |
| 92.00         | ZGM    | LT265/75R16-C WOL (K10903 w/LB4, L03 or LH6 Eng Reqs 3.73 Axle)<br>(K10703 w/LB4 or L03 Eng Reqs 3.73 Axle)   |
| 38.00         | V76    | <b>TOW HOOKS: Two Front (Standard on K1500 Models)</b>  |
|               | Z82    | <b>TRAILERING SPECIAL EQUIPMENT: Heavy-Duty (C-K10903 Reqs VB3 or V43 Bumper)</b><br>(w/MT8 Trans Reqs L05 Eng) (N/A C10703 w/MT8 Trans) (N/A MM5 Trans) (w/LB4 Eng<br>N/A 3.08 Rear Axle Ratio) (Incls Trailer Hitch, Wiring Harness) (w/MX0 Trans Incls V02<br>H.D. Cooler) (w/o Z71 or ZQ8 Chassis Incls F51 Shock Absorbers) (w/Z71 or ZQ8 Chassis<br>Incls Bilstein Shocks) (Also Incls KC4 Eng Oil Cooler w/o LH6 Eng)<br>With Diesel Engine<br>w/VYU or Z71<br>w/o VYU or Z71<br>Without Diesel Engine<br>w/MX0<br>w/VYU<br>w/ZQ8 or Z71<br>w/o VYU, ZQ8 or Z71<br>w/MT8<br>w/R9A or VYU<br>w/o R9A or VYU or ZQ8 or Z71<br>w/ZQ8 or Z71 |
| 273.00        |        |   |
| 313.00        |        |   |
| 273.00        |        |   |
| 408.00        |        |   |
| 448.00        |        |   |
| 210.00        |        |   |
| 385.00        |        |   |
| 345.00        |        |   |
|               |        | <b>TRANSMISSIONS: (Refer Power Teams Chart for Availability)</b>  |
| N.C.          | MM5    | 5-Speed Manual with Overdrive   |
| 98.00         | MT8    | 5-Speed Manual with Deep Low and Overdrive, Heavy-Duty  |
| 890.00        | MX0    | 4-Speed Electronically Controlled Automatic with Overdrive  |
|               |        | <b>WHEEL TRIM: (N/A ZQ8 Sport Chassis)</b>  |
| 42.00         | P01    | Wheel Covers (N/A Silverado Decor)  |
|               | P06    | Rally Wheel Trim (Incl w/Silverado Decor)<br>w/P1A3 or P1A4<br>w/o P1A1 or P1A2   |
| N.C.          |        |   |
| 60.00         |        |   |
|               |        | <b>WHEELS: (Spare is base steel wheel)</b>  |
|               | N90    | Aluminum (C1500 Only) (N/A ZQ8 Chassis)<br>w/P1A3 or P1A4<br>w/P1A1 or P1A2   |
| 250.00        |        |   |
| 310.00        |        |   |
|               | PF4    | Aluminum (K1500 Only)<br>w/P1A3 or P1A4<br>w/P1A1 or P1A2   |
| 250.00        |        |   |
| 310.00        |        |   |
|               | N83    | Chrome Wheel (C1500 Only) (Incl w/ZQ8 Sport Chassis)<br>w/ZQ8 Sport Chassis<br>w/P1A3 or P1A4<br>w/P1A1 or P1A2 or w/o ZQ8  |
| N.C.          |        |   |
| 239.00        |        |   |
| 299.00        |        |   |
| 113.00        | A28    | <b>WINDOW: Sliding Rear</b>   |

## CUSTOM ORDERING OPTIONS

PLEASE REVIEW OPTION RESTRICTIONS BEFORE ORDERING

| INCL<br>W/PEG | OPTION |  |
|---------------|--------|--|
|               |        | <b>SEAT TRIM:</b> (Refer Color/Trim Chart for Availability)  |
| N.C.          | V**1   | Vinyl Bench Seat   |
| 289.00        | V**2   | Vinyl Reclining Low Back Bucket Seats  |
| N.C.          | C**1   | Cloth Bench Seat   |
| 289.00        | C**2   | Cloth Reclining Low Back Bucket Seats  |
| N.C.          | X**1   | Custom Vinyl Bench Seat  |
| 289.00        | X**2   | Custom Vinyl Reclining Low Back Bucket Seats   |
| 174.00        | X**3   | Custom Vinyl Reclining Split Bench Seat  |
| N.C.          | L**1   | Custom Cloth Bench Seat  |
| 174.00        | L**3   | Custom Cloth Reclining Split Bench Seat  |
| 490.00        | L**6   | Custom Cloth Reclining High Back Bucket Seats  |
|               | F51    | <b>SHOCK ABSORBERS:</b> Front and Rear, Heavy Duty (N/A Z71 Off-Road Chassis or ZQ8 Sport Chassis) (Incl w/Z82 Trailering or VYU Snow Plow Pkg)<br>w/R9A, Z82 or VYU<br>w/o R9A, Z82 or VYU  |
| N.C.          |        |  |
| 40.00         | NZZ    | <b>SKID PLATE:</b> Off-Road (K1500 Only) (Incl w/Z71 Off-Road Chassis)<br>w/R9A or Z71<br>w/o R9A or Z71   |
| N.C.          |        |  |
| 95.00         | VYU    | <b>SNOW PLOW PREP PACKAGE:</b> (K1500 Only) (N/A LH6 Eng) (Incls KC4 Eng Oil Cooler) (w/o Z71 Off-Road Package Also Incls F60 Front Springs and F51 Shock Absorbers)<br>w/R9A and Z71<br>w/R9A w/o Z71<br>w/Z71 w/o R9A<br>w/o Z71 or R9A  |
| 55.00         |        |  |
| 118.00        |        |  |
| 190.00        |        |  |
| 293.00        | F60    | <b>SPRINGS:</b> Front, Heavy Duty (K1500 Only) (N/A LH6 Eng or Z71 Off-Road Chassis) (Incl w/VYU Snow Plow Pkg)<br>w/VYU<br>w/o VYU  |
| N.C.          |        |  |
| 63.00         |        |  |
| 59.00         | U16    | <b>TACHOMETER</b><br><b>TIRES:</b> Tubeless, Steel Belted Radial (Refer Tire Chart for Availability) (B/W=Blackwall, W/S=White Stripe, W/L=White Lettered, W/O/L=White Outlined Letter)<br>Front<br>C1500 Models Only<br>P225/75R15 B/W Highway<br>P225/75R15 W/L Highway<br>P235/75R15 B/W Highway<br>w/Diesel Eng or R9A<br>w/o Diesel Eng or R9A<br>P235/75R15 W/S Highway<br>w/Diesel Eng or R9A<br>w/o Diesel Eng or R9A<br>P235/75R15 W/L Highway<br>w/Diesel Eng or R9A<br>w/o Diesel Eng or R9A<br>XCN P275/60R15 B/W Highway (Reqs ZQ8 Sport Chassis)<br>K1500 Models Only<br>XHE LT225/75R16-C B/W Highway<br>XHN LT225/75R16-C WOL On-Off Road<br>XHJ LT225/75R16-C B/W On-Off Road<br>XGL LT265/75R16-C B/W On-Off Road (K10903 w/LB4, L03 or LH6 Eng Reqs 3.73 Axle)<br>(K10703 w/LB4 or L03 Reqs 3.73 Axle)<br>XGM LT265/75R16-C WOL On-Off Road (K10903 w/LB4, L03 or LH6 Eng Reqs 3.73 Axle)<br>(K10703 w/LB4 or L03 Reqs 3.73 Axle)<br>Rear<br>C1500 Models Only<br>YET P225/75R15 B/W Highway<br>YEV P225/75R15 W/L Highway<br>YFL P235/75R15 B/W Highway<br>w/Diesel Eng or R9A<br>w/o Diesel Eng or R9A<br>YFM P235/75R15 W/S Highway<br>w/Diesel Eng or R9A<br>w/o Diesel Eng or R9A<br>YFN P235/75R15 W/L Highway<br>w/Diesel Eng or R9A<br>w/o Diesel Eng or R9A<br>YCN P275/60R15 B/W Highway (Reqs ZQ8 Sport Chassis) |
| N.C.          | XET    |  |
| 50.00         | XEV    |  |
| N.C.          | XFL    |  |
| 28.00         |        |  |
| 36.00         | XFM    |  |
| 64.00         |        |  |
| 50.00         | XFN    |  |
| 78.00         |        |  |
| N.C.          | XCN    |  |
| N.C.          | XHE    |  |
| 72.00         | XHN    |  |
| 22.00         | XHJ    |  |
| 134.00        | XGL    |  |
| 184.00        | XGM    |  |
| N.C.          | YET    |  |
| 50.00         | YEV    |  |
| N.C.          | YFL    |  |
| 28.00         |        |  |
| 36.00         | YFM    |  |
| 64.00         |        |  |
| 50.00         | YFN    |  |
| 78.00         |        |  |
| N.C.          | YCN    |  |

## CUSTOM ORDERING OPTIONS

PLEASE REVIEW OPTION RESTRICTIONS BEFORE ORDERING

|           | INCL<br>w/PEG | OPTION |   |
|-----------|---------------|--------|---|
| N.C.      | 1,2           | ---    | <b>DECOR:</b> (Refer Standard Features Pages for Option Content; Trim Chart for Availability)   |
| N.C.      | 3,4           | YE9    | Cheyenne (N/A w/P1A3, P1A4)<br>Silverado (N/A w/P1A1, P1A2)   |
|           |               |        | <b>EMISSIONS:</b>   |
| N.C.      |               | NA5    | Standard Emission Equipment   |
| N.C.      |               | NA6    | High Altitude Emission Requirement  |
| 100.00    |               | YF5    | California Emission Requirements  |
|           |               |        | <b>ENGINES:</b> (Refer Power Teams Chart for Availability)  |
| N.C.      |               | LB4    | 4.3 Liter (262 Cu In)--EFI V6   |
| N.C.      |               | L03    | 5.0 Liter (305 Cu In)--EFI V8   |
| 575.00    |               |        | w/R9A   |
|           |               |        | w/o R9A   |
| 270.00    |               | L05    | 5.7 Liter (350 Cu In)--EFI V8   |
| 845.00    |               |        | w/R9A   |
|           |               |        | w/o R9A   |
| 1825.00   |               | LH6    | 6.2 Liter (379 Cu In) V8 Diesel   |
| 2400.00   |               |        | w/R9A   |
|           |               |        | w/o R9A   |
| 125.00    |               | KL5    | Alternative Fuel (LPG or CNG Conversion Ready) (N/A C10703 or K10903) (Reqs L05 Eng,<br>MX0 Trans and 6100 GVWR) (K10703 Reqs 3.73 Axle) (C10903 Reqs 3.42 Axle)    |
| (-20.00)  |               | BG9    | <b>FLOOR COVERING:</b> Full Floor, Rubber, Color-Keyed (Replaces Carpeting and Floor Mats)<br>(Reqs Silverado Decor) (Incl w/BB5 Interior Package w/Cheyenne Decor) |
| 84.00     |               | BB5    | <b>INTERIOR PACKAGE:</b> Color-Keyed Cloth Headliner with Matching Retainer Moldings and Floor<br>Covering (Reqs Cheyenne Decor) (Incls BG9 Floor Covering)         |
|           |               |        | <b>LAMPS:</b>   |
| 36.00     |               | UF2    | Cargo Area  |
|           |               | C95    | Dome and Reading (Incl w/TR9 Aux Lighting)  |
| N.C.      |               |        | w/TR9   |
| 33.00     |               |        | w/o TR9   |
| 52.00     |               | U01    | Roof Marker (N/A YF5 Calif Emissions)   |
| N.C.      |               | VK3    | <b>LICENSE PLATE BRACKET:</b> Front   |
|           | 3,4           | TR9    | <b>LIGHTING, AUXILIARY:</b> (Incls C95 Dome and Reading Lamps, Ashtray, Glovebox and<br>Underhood Lamps)  |
| N.C.      |               |        | w/R9A or P1A3 or P1A4   |
| 94.00     |               |        | w/P1A1 or P1A2 w/o R9A  |
|           | 3,4           | D45    | <b>MIRRORS, EXTERIOR:</b>   |
| N.C.      |               |        | Below Eye-Line Type. Stainless Steel  |
| 45.00     |               |        | w/R9A or P1A3 or P1A4   |
|           |               |        | w/P1A1 or P1A2 w/o R9A  |
| 8.00      |               | DF2    | Camper Type. Stainless Steel  |
| 53.00     |               |        | w/R9A or P1A3 or P1A4   |
|           |               |        | w/P1A1 or P1A2 w/o R9A  |
| 90.00     |               | B84    | <b>MOLDING:</b> Exterior, Black (N/A Silverado Decor) (Incls Body Side and Wheel Opening)   |
| 59.00     |               |        | w/E63   |
|           |               |        | w/E62 or ZQ8  |
| N.C.      |               | ZY1    | <b>PAINT, EXTERIOR:</b> (Refer Color/Trim Chart for Availability)   |
| 132.00    |               | ZY2    | Solid   |
| 243.00    |               | ZY4    | Conventional Two-Tone   |
| N.C.      |               | R8T    | Deluxe Two-Tone (N/A E62 Body)  |
|           |               |        | <b>PRICED ORDER ACKNOWLEDGEMENT</b>   |
|           |               |        | <b>RADIO EQUIPMENT:</b> (Electronically Tuned AM Radio is Standard) (Optional Radios Incl<br>Premium Speakers)  |
|           | 2,3           | UM7    | Electronically Tuned AM/FM Stereo Radio w/Seek-Scan and Digital Clock<br>(Incl w/Silverado Decor)   |
| N.C.      |               |        | w/P1A2 or P1A3  |
| 170.00    |               |        | w/P1A1  |
|           | 4             | UM6    | Electronically Tuned AM/FM Stereo Radio w/Seek-Scan, Stereo Cassette Tape and Digital<br>Clock  |
| N.C.      |               |        | w/P1A4 or R9C   |
| 122.00    |               |        | w/P1A2 or P1A3  |
| 292.00    |               |        | w/P1A1  |
|           |               | UX1    | Electronically Tuned AM Stereo/FM Stereo Radio w/Seek-Scan, Stereo Cassette Tape<br>w/Search and Repeat, Graphic Equalizer and Digital Clock                        |
| 150.00    |               |        | w/P1A4 or R9C   |
| 272.00    |               |        | w/P1A2 or P1A3  |
| 442.00    |               |        | w/P1A1  |
| (-117.00) |               | UL5    | Radio Delete (Reqs P1A1)  |

## CUSTOM ORDERING OPTIONS

PLEASE REVIEW OPTION RESTRICTIONS BEFORE ORDERING

| INCL<br>w/PEG             | OPTION  |  |
|---------------------------|---------|--|
|                           | 2,3,4   | C60 <b>AIR CONDITIONING:</b> (K1500 w/L03 Eng and MX0 Trans and 3.73 Axle Ratio Reqs KC4 Eng Oil Cooler)<br>w/P1A2, P1A3 or P1A4<br>w/P1A1   |
| N.C.<br>805.00            |         | V22 <b>APPEARANCE PACKAGE:</b> (Incls Chrome Grille, Composite Halogen Headlamps and Dual Horns) (Incl w/Silverado Decor)<br>w/P1A3 or P1A4<br>w/P1A1 or P1A2  |
| N.C.<br>191.00            |         | <b>AXLES, REAR:</b> (Refer Power Teams Chart for Availability)   |
| N.C.<br>44.00             |         | GQ1 Base   |
| 252.00                    |         | --- Optional   |
| 134.00                    |         | G80 Locking Differential (N/A 3.08 Axle with C1500 Model)  |
|                           |         | TP2 <b>BATTERY:</b> Heavy-Duty, Auxiliary (N/A LB4 or LH6 Eng)   |
| N.C.<br>225.00            |         | BZY <b>BEDLINER:</b> Under Rail (Reqs E63 Body) (N/A P13 Wheel Carrier)<br>w/R9A<br>w/o R9A  |
| N.C.                      |         | <b>BODY CODE:</b>  |
| N.C.                      |         | E62 Sportside Body   |
| N.C.                      | 1,2,3,4 | E63 Fleetside Body   |
|                           |         | <b>BONUS PACKAGES: Manual Transmission Only (Must Specify One)</b><br>(Refer Page 20 for Option Content, Page 21 for Pricing)  |
|                           |         | R9A Work Package   |
|                           |         | R9C Convenience Package (N/A P1A3)   |
|                           |         | R9D Bonus Package Delete   |
|                           |         | <b>BUMPER EQUIPMENT:</b>   |
| 130.00                    |         | V43 Bumper, Painted. Rear Step (Reqs E63 Body)   |
| N.C.<br>26.00<br>229.00   |         | VG3 Bumper, Chromed. Front Deluxe w/Rub Strip (Avail w/E62 Sportside Only) (Incl w/Silverado Decor)<br>w/P1A3 or P1A4<br>w/P1A1 or P1A2  |
|                           |         | VB3 Bumper, Chromed. Rear Step w/Rub Strip (w/E63 Body Reqs Silverado Decor)<br>(w/E62 Body Reqs VG3 Bumper)   |
| 32.00<br>N.C.             |         | V27 Bumper Guards, Front. Black (w/E63 Body Reqs Silverado Decor) (w/E62 Body Reqs VG3 Bumper)   |
|                           |         | P13 <b>CARRIER, SPARE WHEEL AND TIRE:</b> Side Mounted (N/A C-K10703, ZQ8 Sport Chassis or BZY Bedliner)   |
|                           |         | <b>CHASSIS EQUIPMENT:</b>  |
| 135.00<br>270.00          |         | Z71 Off-Road Package (K1500 Only) (Reqs XGL or XGM Tires) (N/A F51 Shocks or F60 Springs)<br>(Incls NZZ Skid Plate and Bilstein Shocks)<br>w/R9A<br>w/o R9A  |
| 664.00<br>774.00          |         | ZQ8 Sport Handling Package (C1500 Only) (Reqs XCN Tires) (N/A LH6 Eng, F51 Shocks, P13 Carrier, P01 or P06 Wheel Covers or N90 Wheels) (Incls Bilstein Gas Shocks and N83 Chrome Wheels)<br>w/P1A3 or P1A4<br>w/R9A<br>w/o R9A<br>w/P1A1 or P1A2<br>w/R9A<br>w/o R9A |
| 755.00<br>865.00<br>33.00 |         | V10 <b>COLD-CLIMATE PACKAGE:</b> (N/A LH6 Eng) (Incls Eng Block Heater)  |
|                           |         | <b>CONVENIENCE GROUP:</b>  |
| N.C.<br>367.00            | 4       | ZQ2 Power Door Locks and Windows<br>w/P1A4 or R9C<br>w/P1A1, P1A2 or P1A3  |
| N.C.<br>383.00            | 4       | ZQ3 Comfortit Steering and Speed Control<br>w/P1A4 or R9C<br>w/P1A2, P1A2 or P1A3  |
|                           |         | <b>COOLING SYSTEM:</b>   |
| N.C.<br>135.00<br>56.00   |         | KC4 Engine Oil (w/MX0 Trans Reqs V02 Cooling) (N/A LH6 Eng) (Incl w/Z82 Trailering or VYU Snow Plow Prep)<br>w/R9A/Z82 or VYU Pkg<br>w/o R9A or Z82  |
|                           |         | V01 Radiator, Heavy-Duty (C1500 w/C60 Air Avail Only When LH6 Diesel Eng and 3.08 or 3.42 Axle Ratio is Specified) (K1500 w/C60 Air Avail Only When LH6 Diesel Eng and 3.42 Axle Ratio is Specified) (N/A V02 Cooling or Z82 Trailering)                             |
| N.C.<br>63.00             |         | V02 Radiator and Trans Oil, Heavy-Duty (Reqs MX0 Trans) (w/LB4 or L05 Eng and C60 Air Reqs KC4 Eng Oil Cooler) (N/A V01 Cooling) (Incl w/Z82 Trailering)<br>w/Z82<br>w/o Z82   |

**\*MANUAL TRANSMISSION BONUS PACKAGE PRICES**

| <u>BONUS PKG</u>             | <u>BONUS PKG MSRP</u> | <u>BONUS PKG</u>             | <u>BONUS PKG MSRP</u> |
|------------------------------|-----------------------|------------------------------|-----------------------|
| <b>R9A - C1500</b>           |                       | <b>R9A - K1500</b>           |                       |
| w/PEG P1A1 or P1A2           |                       | w/PEG P1A1 or P1A2           |                       |
| w/E63                        |                       | w/E63                        |                       |
| w/o Diesel Engine            | 1184.00               | w/o Diesel Engine            | 1209.00               |
| w/Diesel Engine              | 979.00                | w/Diesel Engine              | 1074.00               |
| w/E62                        | 959.00                | w/E62                        | 984.00                |
| w/PEG P1A4 or P1A3           |                       | w/PEG P1A4 or P1A3           |                       |
| w/E63                        |                       | w/E63                        |                       |
| w/o Diesel Engine            | 1045.00               | w/o Diesel Engine            | 1070.00               |
| w/Diesel Engine              | 840.00                | w/Diesel Engine              | 935.00                |
| w/E62                        | 820.00                | w/E62                        | 845.00                |
| <b>R9A BONUS PKG SAVINGS</b> | <b>(-500.00)</b>      | <b>R9A BONUS PKG SAVINGS</b> | <b>(-500.00)</b>      |

| <u>BONUS PKG</u>             | <u>BONUS PKG MSRP</u> |
|------------------------------|-----------------------|
| <b>R9C</b>                   |                       |
| w/PEG P1A1                   | 1042.00               |
| w/PEG P1A2                   | 872.00                |
| w/PEG P1A4                   | N.C.                  |
| <b>R9C BONUS PKG SAVINGS</b> | <b>(-500.00)</b>      |

**\*Bonus Package Prices shown do not include Preferred Equipment Group Prices or Discounts, Upgrades or Substitutions.**

REVISED: 1-22-93

1993 ORDER GUIDE

C/K REGULAR CAB PICKUP

Prices Shown Are Manufacturer's Suggested Retail Prices (MSRP) At The Time Of Publication. These Prices Are To Be Used Only As An Aid To Inventory Management Since MSRP Figures Change Periodically. The Vehicle Price Schedule Is The Official Pricing Documentation Of Chevrolet Motor Division And Should Be Used In Discussing Vehicle Prices With Potential Buyers. The Model Prices Shown In The Order Guide Include The Destination Freight Charges.

## **C/K 1500 MANUAL TRANSMISSION BONUS PACKAGE**

**When a Manual Transmission is Specified on The Order, One of The Option Groups Listed Below Must be Selected in Addition to The PEG. Refer Custom Ordering Options for Restrictions.**

### **R9A**

#### **WORK PACKAGE**

- TR9** - Auxiliary Lighting
- KC4** - Engine Oil Cooler (w/o LH6 Eng)
- D45** - Mirrors, Stainless Steel (A)
- \*FL** - P235 B/W Tires (C1500 Only) (B)
- F51** - Shock Absorbers (C)
- NZZ** - Skid Plate (K1500 Only) (D)
- L03** - 5.0L V8 (E)
- BZY** - Bedliner w/E63 Only

### **R9C (N/A P1A3)**

#### **CONVENIENCE PACKAGE**

- ZQ2** - Convenience Group: Power Door Locks and Power Windows
- ZQ3** - Convenience Group: Comfortilt Steering and Speed Control
- UM6** - Stereo Cassette w/Clock (F)

### **R9D**

#### **BONUS PACKAGE DELETE**

Manual Transmission Bonus Package Not Desired

---

#### **Allowable Substitutions (Where Available):**

- (A) D45: May substitute DF2 Mirrors
- (B) \*FL: May substitute P235 or P275 Tires. Refer Tire Chart
- (C) F51: May substitute Z71 Off-Road Chassis or ZQ8 Sport Chassis
- (D) NZZ: May substitute Z71 Off-Road Chassis
- (E) L03: May substitute L05 5.7L V8 or LH6 Diesel. Refer Power Team Chart
- (F) UM6: May substitute UX1 Radio

**Refer Page 29 For Manual Transmission Bonus Package Pricing**

**PREFERRED VEHICLE**

**No Deletions Allowed, Additional Options/Upgrades (Where Indicated)  
 May be Ordered from the Custom Ordering Option Listing**

**MUST SPECIFY:**

**EMISSION, ENGINE, TRANSMISSION, AXLE AND TIRES**

|              |   | CHEYENNE         |                  | SILVERADO        |                  |
|--------------|---|------------------|------------------|------------------|------------------|
|              |   | P<br>1<br>A<br>1 | P<br>1<br>A<br>2 | P<br>1<br>A<br>3 | P<br>1<br>A<br>4 |
| N.C.         | <b>Preferred Equipment Group 1</b>                                    |                  |                  |                  |                  |
| *(-890.00)   | <b>PEG 1 Savings w/MX0 and LB4</b>                                    |                  |                  |                  |                  |
|              | Body: Fleetside (E62 may be Substituted on C-K10703 Models) ..... E63 | x                | x                | x                | x                |
| *975.00      | <b>Preferred Equipment Group 2</b>                                    |                  |                  |                  |                  |
| **(-500.00)  | <b>PEG 2 Savings</b>  |                  |                  |                  |                  |
| **(-1390.00) | w/MX0 and LB4   |                  |                  |                  |                  |
|              | Air Conditioning ..... C60  |                  | x                | x                | x                |
|              | Radio: AM/FM Stereo w/Clock (A) ..... UM7                             |                  | x                | x                | N/I              |
| *1908.00     | <b>Preferred Equipment Group 3</b>                                    |                  |                  |                  |                  |
| **(-750.00)  | <b>PEG 3 Savings</b>  |                  |                  |                  |                  |
| **(-1250.00) | w/MX0 and LB4 or L03  |                  |                  |                  |                  |
|              | Silverado Decor ..... YE9   |                  |                  | x                | x                |
|              | Lighting, Auxiliary ..... TR9   |                  |                  | x                | x                |
|              | Mirrors: Below Eye-Line, Stainless Steel (B) ..... D45                |                  |                  | x                | x                |
| *2780.00     | <b>Preferred Equipment Group 4</b>                                    |                  |                  |                  |                  |
| **(-1000.00) | <b>PEG 4 Savings</b>  |                  |                  |                  |                  |
| **(-1500.00) | w/MX0 and LB4 or L03  |                  |                  |                  |                  |
|              | Convenience Group: Comfortilt Steering and Speed Control ..... ZQ3    |                  |                  |                  | x                |
|              | Convenience Group: Power Door Locks and Windows ..... ZQ2             |                  |                  |                  | x                |
|              | Radio: AM/FM Stereo w/Tape and Clock (C) ..... UM6                    |                  |                  |                  | x                |

\*The Preferred Equipment Group MSRPs Reflect the Basic Group Equipment Prices. For any Option Additions, Upgrades or Substitutions. Refer to the Vehicle Price Schedule for any Price Differential.  
 \*\*PEG Savings Amount represents the savings for Preferred Equipment Groups.

Allowable Substitutions (Where Available):  
 (A) UM7: May substitute UM6 or UX1 Stereo Radio  
 (B) D45: May substitute DF2 Mirrors  
 (C) UM6: May substitute UX1 Stereo Radio

**WITH MANUAL TRANSMISSION, "BONUS PACKAGE" MUST BE ORDERED.  
 REFER PAGE 28 FOR SELECTION**



**TIRES: Must Specify Front, Rear and Spare**

| Description                         | Highway |      | On-Off Road |      |       |
|-------------------------------------|---------|------|-------------|------|-------|
|                                     | Front   | Rear | Front       | Rear | Spare |
| <b>C1500 Models Only</b>            |         |      |             |      |       |
| <b>TUBELESS Steel Belted Radial</b> |         |      |             |      |       |
| P225/75R15 B/W                      | XET     | YET  |             |      | ZET   |
| P225/75R15 W/L                      | XEV     | YEV  |             |      | ZEV   |
| P235/75R15 B/W                      | XFL     | YFL  |             |      | ZFL   |
| P235/75R15 W/S                      | XFM     | YFM  |             |      | ZFM   |
| P235/75R15 W/L                      | XFN     | YFN  |             |      | ZFN   |
| (a) P275/60R15 B/W                  | XCN     | YCN  |             |      | ZCN   |
| <b>K1500 Models Only</b>            |         |      |             |      |       |
| <b>TUBELESS Steel Belted Radial</b> |         |      |             |      |       |
| LT225/75R16-C B/W                   | XHE     | YHE  |             |      | ZHE   |
| LT225/75R16-C WOL                   |         |      | XHN         | YHN  | ZHN   |
| LT225/75R16-C B/W                   |         |      | XHJ         | YHJ  | ZHJ   |
| (b) LT265/75R16-C B/W               |         |      | XGL         | YGL  | ZGL   |
| (b) LT265/75R16-C WOL               |         |      | XGM         | YGM  | ZGM   |

(a) Reqs ZQ8 Sport Chassis  
 (b) K10903 w/LB4, L03 or LH6 Eng Reqs 3.73 Axle; K10703, w/LB4 or L03 Reqs 3.73 Axle

B/W=Blackwall  
 W/S=White Stripe  
 W/L=White Lettered  
 WOL=White Outlined Letter

**POWER TEAMS (Continued)**

(Consult GVWR Selector For Minimum Equipment Required)

| ENGINE  | TRANSMISSION |      | AXLES   |         |         | GVWR          |
|---|--------------|------|---------|---------|---------|---------------|
|   | 5-SP         | AUTO | 3.08    | 3.42    | 3.73    |               |
| <b>W/NA6 HIGH ALTITUDE EMISSION EQUIPMENT</b> |              |      |         |         |         |               |
| <b>C10703-C10903</b>                          |              |      |         |         |         |               |
| LB4 V6 4.3 Liter<br>(262 Cu In)--EFI          | MT8(a)/MM5   |      | (g) GQ1 | GU6     | --      | (f) 5600/6100 |
|   |              | MX0  | --      | GQ1     | (c) GT4 | (f) 5600/6100 |
| L03 V8 5.0 Liter<br>(305 Cu In)--EFI          | MM5          | MX0  | (g) GQ1 | GU6     | --      | (f) 5600/6100 |
| L05 V8 5.7 Liter<br>(350 Cu In)--EFI          | MT8(a)/MM5   |      | (g) GQ1 | GU6     | --      | (f) 5600/6100 |
|   |              | MX0  | (g) GQ1 | GU6     | (c) GT4 | (f) 5600/6100 |
| (a) LH6 Diesel V8 6.2 Liter<br>(379 Cu In)    | MT8          |      | (g) GQ1 | GU6     | --      | 6100          |
|   |              | MX0  | (g) GQ1 | GU6     | GT4     | 6100          |
| <b>K10703-K10903</b>                          |              |      |         |         |         |               |
| LB4 V6 4.3 Liter<br>(262 Cu In)--EFI          | MM5          |      | ---     | ---     | (h) GT4 | 6100          |
|   | MT8          | MX0  | --      | (b) GQ1 | (d) GT4 | 6100          |
| L03 V8 5.0 Liter<br>(305 Cu In)--EFI          | MM5          | MX0  | --      | (b) GQ1 | (e) GT4 | 6100          |
| L05 V8 5.7 Liter<br>(350 Cu In)--EFI          | MM5/MT8      | MX0  | --      | GQ1     | (d) GT4 | 6100          |
| (a) LH6 Diesel V8 6.2 Liter<br>(379 Cu In)    | MT8          | MX0  | --      | (b) GQ1 | GT4     | 6100          |
| <b>W/YF5 CALIFORNIA EMISSION REQUIREMENTS</b> |              |      |         |         |         |               |
| <b>C10703-C10903</b>                          |              |      |         |         |         |               |
| LB4 V6 4.3 Liter<br>(262 Cu In)--EFI          | MT8(a)/MM5   | MX0  | (g) GQ1 | GU6     | --      | (f) 5600/6100 |
| L03 V8 5.0 Liter<br>(305 Cu In)--EFI          |              | MX0  | (g) GQ1 | GU6     | --      | (f) 5600/6100 |
| L05 V8 5.7 Liter<br>(350 Cu In)--EFI          | MM5          |      | (g) GQ1 | GU6     | --      | (f) 5600/6100 |
|   |              | MX0  | (g) GQ1 | GU6     | (c) GT4 | (f) 5600/6100 |
| <b>K10703-K10903</b>                          |              |      |         |         |         |               |
| LB4 V6 4.3 Liter<br>(262 Cu In)--EFI          | MM5          |      | ---     | ---     | (h) GT4 | 6100          |
|   | MT8          | MX0  | --      | (b) GQ1 | (d) GT4 | 6100          |
| L03 V8 5.0 Liter<br>(305 Cu In)--EFI          |              | MX0  | --      | (b) GQ1 | (e) GT4 | 6100          |
| L05 V8 5.7 Liter<br>(350 Cu In)--EFI          | MM5          | MX0  | --      | GQ1     | (d) GT4 | 6100          |

- (a) N/A C-K10703
- (b) N/A LT265/75R16C Tires
- (c) Reqs KC4 Cooler and V02 H.D. Cooling
- (d) Reqs KC4 Cooler; w/MX0 Also Reqs V02 H.D. Cooling
- (e) w/MX0 Trans and C60 Air, Reqs KC4 Cooler and V02 H.D. Cooling
- (f) 6100 GVW N/A C10703
- (g) N/A G80 Differential
- (h) Reqs KC4 Cooler; base at no charge, GQ1 will be added by system

REVISED: 1-22-93

1993 ORDER GUIDE

C/K REGULAR CAB PICKUP

Page

Prices Shown Are Manufacturer's Suggested Retail Prices (MSRP) At The Time Of Publication. These Prices Are To Be Used Only As An Aid To Inventory Management Since MSRP Figures Change Periodically. The Vehicle Price Schedule Is The Official Pricing Documentation Of Chevrolet Motor Division And Should Be Used In Discussing Vehicle Prices With Potential Buyers. The Model Prices Shown In The Order Guide Include The Destination Freight Charges.

### EMISSIONS (Must Specify One)

NA5 Standard Emission Equipment  
NA6 High Altitude Emission Equipment  
YF5 California Emission Requirements

### POWER TEAMS (Must Specify Engine, Transmission and Rear Axle)

(Consult GVWR Selector For Minimum Equipment Required)

| ENGINE                                     | TRANSMISSION |      | AXLES   |         |         | GVWR          |
|--|--------------|------|---------|---------|---------|---------------|
|  | 5-SP         | AUTO | 3.08    | 3.42    | 3.73    |               |
| <b>W/NA5 STANDARD EMISSION EQUIPMENT</b>   |              |      |         |         |         |               |
| <b>C10703-C10903</b>                       |              |      |         |         |         |               |
| LB4 V6 4.3 Liter<br>(262 Cu In)--EFI       | MT8(a)/MM5   | MX0  | (g) GQ1 | GU6     | --      | (f) 5600/6100 |
| L03 V8 5.0 Liter<br>(305) Cu In)--EFI      | MM5          | MX0  | (g) GQ1 | GU6     | --      | (f) 5600/6100 |
| L05 V8 5.7 Liter<br>(350 Cu In)--EFI       | MT8(a)/MM5   |      | (g) GQ1 | GU6     | --      | (f) 5600/6100 |
|  |              | MX0  | (g) GQ1 | GU6     | (c) GT4 | (f) 5600/6100 |
| (a) LH6 Diesel V8 6.2 Liter<br>(379 Cu In) | MT8          | MX0  | (g) GQ1 | GU6     | --      | 6100          |
| <b>K10703-K10903</b>                       |              |      |         |         |         |               |
| LB4 V6 4.3 Liter<br>(262 Cu In)--EFI       | MM5          |      | --      | --      | (h) GT4 | 6100          |
|  | MT8          | MX0  | --      | (b) GQ1 | (d) GT4 | 6100          |
| L03 V8 5.0 Liter<br>(305 Cu In)--EFI       | MM5          | MX0  | --      | (b) GQ1 | (e) GT4 | 6100          |
| L05 V8 5.7 Liter<br>(350 Cu In)--EFI       | MM5/MT8      | MX0  | --      | GQ1     | (d) GT4 | 6100          |
| (a) LH6 Diesel V8 6.2 Liter<br>(379 Cu In) | MT8          | MX0  | --      | (b) GQ1 | GT4     | 6100          |

- (a) N/A C-K10703 Models
- (b) N/A LT265/75R16-C Tires
- (c) Reqs KC4 Cooler and V02 H.D. Cooling
- (d) Reqs KC4 Cooler; w/MX0 Trans Also Reqs V02 H.D. Cooling
- (e) w/MX0 Trans and C60 Air, Reqs KC4 Cooler and V02 H.D. Cooling
- (f) 6100 GVW N/A C10703
- (g) N/A G80 Differential
- (h) Reqs KC4 Cooler; base at no charge, GQ1 will be added by system

CONTINUED ON PAGE 25

C/K REGULAR CAB PICKUP

1993 ORDER GUIDE

REVISED: 1-22-93

Page 24

Prices Shown Are Manufacturer's Suggested Retail Prices (MSRP) At The Time Of Publication. These Prices Are To Be Used Only As An Aid To Inventory Management Since MSRP Figures Change Periodically. The Vehicle Price Schedule Is The Official Pricing Documentation Of Chevrolet Motor Division And Should Be Used In Discussing Vehicle Prices With Potential Buyers. The Model Prices Shown In The Order Guide Include The Destination Freight Charges.

**MODEL AND BODY**

|                             | Description     | Model No | Body |
|-----------------------------|-----------------|----------|------|
| <b>2-WHEEL-DRIVE MODELS</b> |                 |          |      |
| 14,580.00                   | Sportside ..... | CC10703  | E62  |
| 14,180.00                   | Fleetside ..... | CC10703  | E63  |
| 14,480.00                   | Fleetside ..... | CC10903  | E63  |

|                             | Description     | Model No | Body |
|-----------------------------|-----------------|----------|------|
| <b>4-WHEEL-DRIVE MODELS</b> |                 |          |      |
| 16,830.00                   | Sportside ..... | CK10703  | E62  |
| 16,430.00                   | Fleetside ..... | CK10703  | E63  |
| 16,720.00                   | Fleetside ..... | CK10903  | E63  |

**\*GVWR SELECTOR**

**Minimum Equipment Required for GVW Rating**

| GVW Rating (lbs) | GAWR* |      |  |
|------------------|-------|------|--|
|                  | Front | Rear |  |
| <b>C10703</b>    |       |      |  |
| 5600             | 2950  | 3404 | N/A LH6                                    |
| <b>C10903</b>    |       |      |  |
| 5600             | 2950  | 3404 | Reqs YET or YEV Tires; N/A LH6 or KL5      |
| 6100             | 3150  | 3686 | w/o ZQ8 Reqs YFL, YFM, YFN; w/ZQ8 Reqs YCN |
| <b>K10703</b>    |       |      |  |
| 6100             | 3600  | 3750 | N/A LH6                                    |
| <b>K10903</b>    |       |      |  |
| 6100             | 3600  | 3750 | None                                       |

\*GAWR's shown are the minimum for each axle with equipment listed. Other GAWR's are available, and they are determined as the minimum capacity of either axle, springs or tires.

**CAPACITIES**

| C10703-C10903   |      |             |
|-----------------|------|-------------|
| <b>SPRINGS:</b> |      |             |
| Front           | 2950 |             |
| Rear            | 3750 |             |
| <b>AXLES:</b>   |      |             |
| Front           | 3150 |             |
| Rear            | 3404 | Base        |
|                 | 3750 | w/6100 GVWR |

| K10703          |      |
|-----------------|------|
| <b>SPRINGS:</b> |      |
| Front           | 3600 |
| Rear            | 3750 |
| <b>AXLES:</b>   |      |
| Front           | 3925 |
| Rear            | 3750 |

| K10903          |      |
|-----------------|------|
| <b>SPRINGS:</b> |      |
| Front           | 3600 |
| Rear            | 3750 |
| <b>AXLES:</b>   |      |
| Front           | 3925 |
| Rear            | 3750 |

## OPTIONAL UPLEVEL DECOR

### SILVERADO DECOR LEVEL (RPO YE9)

The following equipment is in addition to or replacing items included in the Cheyenne decor

#### EXTERIOR

Bumper: Chrome front bumper includes a black rub strip with bright trim

Grille: Deluxe front appearance package with dark argnet grille and bright trim

Headlamps: Dual composite halogen

Horn: Dual low and high note electric

Moldings: Black body side moldings with bright trim and bright wheel opening moldings

Nameplate: Silverado

Wheels: Rally wheel trim

#### INTERIOR

Floor Covering: Color-keyed carpeting

Floor Mats: Front removable color-keyed floor mats

Headliner: Color-keyed cloth headliner with matching retainer molding

Lamp: Dome with dual door jamb switches

Radio: Electronically tuned AM/FM stereo w/seek-scan and digital clock

Seats: 3-passenger with choice of custom vinyl or custom cloth front bench seat with head restraint and folding backrest. Optional bucket seats include console

Steering Wheel, Sport

Storage Tray: Full width storage tray behind seat on floor

Sunshades: Cloth covered with storage strip on LH unit and visor mirror on RH unit

**MODELS PASSENGERS**

|   |   |
|---|---|
| Sportside 2-wheel drive (CC10703) ..... | 3 |
| Sportside 4-wheel drive (CK10703) ..... | 3 |
| Fleetside 2-wheel drive (CC10703) ..... | 3 |
| Fleetside 2-wheel drive (CC10903) ..... | 3 |
| Fleetside 4-wheel drive (CK10703) ..... | 3 |
| Fleetside 4-wheel drive (CK10903) ..... | 3 |

**DIMENSIONS**

|                                 |         |
|---------------------------------|---------|
| <b>Wheelbase (inches)</b>       |         |
| CC10703/CK10703 .....           | 117.5   |
| CC10903/CK10903 .....           | 131.5   |
| <b>Cab-Axle (inches)</b>        |         |
| CC10703/CK10703 .....           | 41.8    |
| CC10903/CK10903 .....           | 55.9    |
| <b>Length (overall--inches)</b> |         |
| Sportside .....                 | 194.0   |
| Fleetside                       |         |
| CC10703/CK10703 .....           | 194.1   |
| CC10903/CK10903 .....           | 212.6   |
| <b>Width (overall-inches)</b>   |         |
| Sportside .....                 | 77.1    |
| Fleetside .....                 | 76.8    |
| <b>Box Size</b>                 |         |
| Length (overall - inches)       |         |
| CC10703/CK10703 .....           | 78.7    |
| CC10903/CK10903 .....           | 97.6    |
| Box Depth (inches) .....        | 19.3    |
| <b>Payload (pounds)</b>         |         |
| CC10703                         |         |
| w/E62 .....                     | 1872    |
| w/E63 .....                     | 1899    |
| CK10703                         |         |
| w/E62 .....                     | 1935    |
| w/E63 .....                     | 1968    |
| CC10903                         |         |
| w/o Diesel Engine .....         | 1762    |
| w/Diesel Engine .....           | 1741    |
| CK10903                         |         |
| w/o Diesel Engine .....         | 1817    |
| w/Diesel Engine .....           | 1440    |
| <b>GVWR</b>                     |         |
| CC10703 .....                   | 5600    |
| CC10903 .....                   | 5600    |
| CK10703/CK10903 .....           | 6100    |
| <b>Fuel Tank Capacity</b>       |         |
| CC10703/CK10703 .....           | 25 Gal. |
| CC10903/CK10903 .....           | 34 Gal. |

**POWER TEAMS**

|   |    |
|---|----|
| Standard Engine   |    |
| RPO LB4 4.3 Liter (262 Cu In) V6 with Electronic Fuel Injection (EFI) |    |
| Standard Transmission   |    |
| RPO MM5 5-speed manual  |    |
| Standard Rear Axle Ratio  |    |
| CC10703/CC10903 .....   | 3. |
| CK10703/CK10903 .....   | 3. |

**STANDARD EQUIPMENT SUMMARY**

**EXTERIOR**

Air Dam: Black  
 Brakes: Power assisted front disc, rear drum. Rear wheel anti-lock  
 Bumper: Chromed front bumper  
 Grille: Molded plastic painted light argent and dark argent  
 Headlamps: Single rectangular halogen headlamps  
 Mirrors: RH and LH below-eye-line, painted black  
 Nameplate: Cheyenne  
 Spare Tire/Wheel: Full-size spare tire and wheel  
 Spare Tire Carrier: Winch-type spare tire carrier mounted under the frame at the rear  
 Tires:  
     CC10703/CC10903--P225/75R15 All Seasons Steel Belted Radial Ply BW  
     CK10703/CK10903--LT225/75R16C All Seasons Steel Belted Radial Ply BW  
 Tow Hooks: Two front tow hooks on 4-wheel drive models  
 Wheels: Silver painted steel wheels with black hub ornament  
 Windshield Wipers: Intermittent

**INTERIOR**

Cigarette Lighter  
 Cupholders, under dash  
 Dome Lamp: With switch in LH and RH door jamb  
 Floor Covering: Embossed black rubber mat  
 Gages: Including fuel level, odometer, oil pressure, speedometer, telltale lights, temperature and voltmeter  
 Glass: Tinted, Solar-Ray, all windows  
 Glove Box: Latched door and beverage holder  
 Headliner: Color-keyed vinyl  
 Heater: Deluxe heater with windshield and side window defoggers  
 Mirrors: 10-inch rearview mirror  
 Radio: Electronically-tuned AM radio with fixed mast antenna  
 Scotchgard™ Fabric Protector on cloth trim and door panels  
 Seats: 3-Passenger all vinyl trim front bench seat with folding backrest. Optional split bench and bucket seats include folding backrest. Bucket seats also include console  
 Steering Wheel: Custom urethane 4-spoke steering wheel  
 Sunshades: Color-keyed vinyl RH and LH padded sunshades

**C/K REGULAR CAB PICKUP**

**1993 ORDER GUIDE**

**REVISED: 1-22-93**

Page 20

Prices Shown Are Manufacturer's Suggested Retail Prices (MSRP) At The Time Of Publication. These Prices Are To Be Used Only As An Aid To Inventory Management Since MSRP Figures Change Periodically. The Vehicle Price Schedule Is The Official Pricing Documentation Of Chevrolet Motor Division And Should Be Used In Discussing Vehicle Prices With Potential Buyers. The Model Prices Shown In The Order Guide Include The Destination Freight Charges.

**C/K1500 SPORT TRUCK PICKUP  
INTERIOR AND EXTERIOR COLOR AVAILABILITY CHART  
WITH ZY1 PAINT**

**PLEASE NOTE:** Below are the interior trim color and exterior paint combinations recommended by Chevrolet. They are the only available interior and exterior combinations allowed.

| TRIM LEVEL                                       |  | Decor        | INTERIOR COLORS |  |        |      |
|--|--|--------------|-----------------|--|--------|------|
| Seat Type  |  |              | Beige           | Blue   | Garnet | Gray |
| <b>SILVERADO</b>                                 |  | YE9          |                 |  |        |      |
| Custom Vinyl Bench Seat                          |  |              | XUU1            | XDD1   | XRR1   | XQQ1 |
| Custom Cloth Bench Seat                          |  |              | LUU1            | LDD1   | LRR1   | LQQ1 |
| Custom Vinyl Reclining Split Bench Seat          |  |              | XUU3            | XDD3   | XRR3   | XQQ3 |
| Custom Cloth Reclining Split Bench Seat          |  |              | LUU3            | LDD3   | LRR3   | LQQ3 |
| Custom Vinyl Reclining Low Back<br>Bucket Seats  |  |              | XUU2            | XDD2   | XRR2   | XQQ2 |
| Custom Cloth Reclining High Back<br>Bucket Seats |  |              | LUU6            | LDD6   | LRR6   | LQQ6 |
| EXTERIOR COLORS                                  |  | Color Code 1 | Color Code 2    | INTERIOR & EXTERIOR COMBINATIONS SHOWN ARE THE ONLY COMBINATIONS AVAILABLE |        |      |
| BLACK, ONYX                                      |  | 41           | 41              | x  |        | x    |
| RED, VICTORY                                     |  | 74           | 74              |  | x      | x    |
| WHITE, SUMMIT                                    |  | 50           | 50              | x  | x      | x    |

**SOLID PAINT -- ZY1**

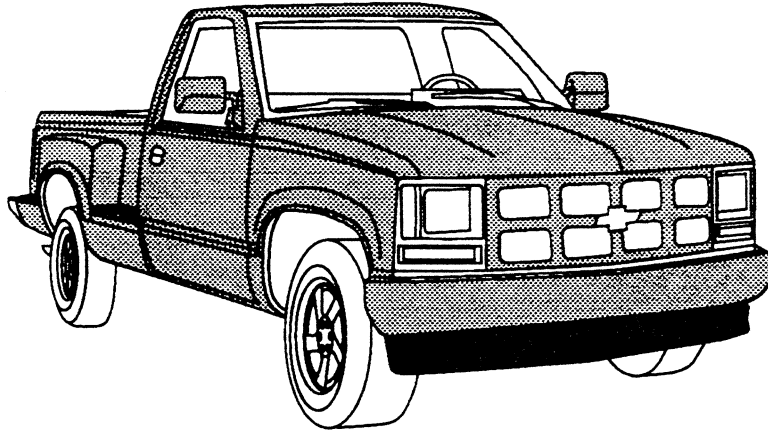



**CUSTOM ORDERING OPTIONS**  
PLEASE REVIEW OPTION RESTRICTIONS BEFORE ORDERING

| INCL<br>w/PEG | OPTION |   |
|---------------|--------|---|
|               |        | <b>TIRES:</b> Tubeless, Steel Belted Radial (Refer Tire Chart for Availability) (B/W=Blackwall) |
|               |        | Front   |
| N.C.          | XFL    | P235/75R15 B/W (Highway) (C10703 Only)  |
| N.C.          | XGL    | LT265/75R16-C B/W (On-Off Road) ( K10703 Only; w/LB4 or L03 Reqs 3.73 Axle)                     |
| N.C.          | XCN    | P275/60R15 B/W (Highway) (C10703 Only; Reqs ZQ8 Sport Chassis)                                  |
|               |        | Rear  |
| N.C.          | YFL    | P235/75R15 B/W (Highway) (C10703 Only)  |
| N.C.          | YGL    | LT265/75R16-C B/W (On-Off Road) ( K10703 Only; w/LB4 or L03 Reqs 3.73 Axle)                     |
| N.C.          | YCN    | P275/60R15 B/W (Highway) (C10703 Only; Reqs ZQ8 Sport Chassis)                                  |
|               |        | Spare   |
| N.C.          | ZFL    | P235/75R15 B/W (On-Off Road) (C10703 Only)  |
| N.C.          | ZGL    | LT265/75R16-C B/W (On-Off Road) ( K10703 Only; w/LB4 or L03 Reqs 3.73 Axle)                     |
| N.C.          | ZCN    | P275/60R15 B/W (On-Off Road) (C10703 Only; Reqs ZQ8 Sport Chassis)                              |
|               |        | <b>TRANSMISSIONS:</b> (Refer Power Teams Chart for Availability)                                |
| N.C.          | MM5    | 5-Speed Manual with Overdrive   |
| 98.00         | MT8    | 5-Speed Manual with Deep Low and Overdrive, Heavy-Duty  |
| 890.00        | MX0    | 4-Speed Electronically Controlled Automatic with Overdrive                                      |
|               | A28    |   |
|               |        | <b>WINDOW:</b> Sliding Rear   |
| N.C.          |        | w/R9A   |
| 113.00        |        | w/o R9A   |

232 Trailering Special Equipment  
 (w/MT8 Trans Reqs L03 Engine)  
 (w/LB4 or L03 Reqs 3.73 Rear Axle)  
 (Incis Trailer Hitch and Wiring Harness)  
 (w/MX0 Trans Reqs V02 H/O Cooler) or ZT  
 or ZQ8 Chassis (Incis F51 shock absorbers)  
 (w/Z37 or ZQ8 Incis 8" steel discs) or ZT  
 KCA (w/o or cooler)  
 w/mx0 -  
 w/ZQ8 or ZT  
 w/ZQ8 or ZT  
 w/MT8  
 w/R9A  
 w/o R9A, ZQ8 or ZT

113.00  
 113.00  
 113.00  
 113.00

### CUSTOM ORDERING OPTIONS

PLEASE REVIEW OPTION RESTRICTIONS BEFORE ORDERING

| INCL<br>w/PEG | OPTION | DESCRIPTION   |
|---------------|--------|---|
| N.C.          | 1      | C60 <b>AIR CONDITIONING:</b> (K1500 w/L03 Eng and MX0 Trans and 3.73 Axle Reqs KC4 Eng Oil Cooler)  |
| N.C.          |        | <b>AXLES, REAR:</b> (Refer Power Teams Chart for Availability)  |
| 44.00         |        | GQ1 Base  |
| 252.00        |        | Optional  |
| 134.00        |        | G80 Locking Differential (N/A 3.08 Axle)  |
| N.C.          | 1      | TP2 <b>BATTERY:</b> Heavy-Duty. Auxiliary (K10703 Only)   |
|               |        | E62 <b>BODY CODE:</b> 6-1/2 Ft. Sportside   |
|               |        | <b>BONUS PACKAGES:</b> Manual Transmission Only (Must Specify One) (Refer Page 16 for Option Content and Pricing)                             |
|               |        | R9A Work Package  |
|               |        | R9C Convenience Package   |
|               |        | R9D Bonus Package Delete  |
|               |        | <b>CHASSIS EQUIPMENT:</b>   |
| 135.00        |        | Z71 Off-Road Chassis Package (K10703 Only) (N/A F51 Shocks) (Incls Skid Plate and Bilstein Shocks)  |
| 270.00        |        | w/R9A   |
| 1065.00       |        | w/o R9A   |
|               |        | ZQ8 Sport Handling Package (C10703 Only) (Reqs XCN Tires) (N/A F51 Shocks) (Incls Bilstein Gas Shocks and Chrome Wheels)                      |
| 33.00         |        | V10 <b>COLD-CLIMATE PACKAGE:</b> (Incls Eng Block Heater)   |
|               |        | <b>CONVENIENCE GROUP:</b>   |
| N.C.          | 1      | ZQ2 Power Door Locks and Windows  |
| N.C.          | 1      | ZQ3 Comfortilt Steering and Speed Control   |
|               |        | <b>COOLING SYSTEM:</b>  |
|               |        | KC4 Engine Oil (w/MX0 Trans Reqs V02 Cooling)   |
| N.C.          |        | w/R9A   |
| 135.00        |        | w/o R9A   |
| 63.00         |        | V02 Radiator and Trans Oil, Heavy-Duty (Reqs MX0 Trans) (w/L05 or LB4 Eng Reqs KC4 Cooling)   |
|               |        | <b>DECOR:</b> (Refer Standard Features Page for Option Content)   |
|               | 1      | YE9 Silverado   |
|               |        | <b>EMISSIONS:</b>   |
| N.C.          |        | NA5 Standard Emission Equipment   |
| N.C.          |        | NA6 High Altitude Emission Requirement  |
| 100.00        |        | YF5 California Emission Requirements  |
|               |        | <b>ENGINES:</b> (Refer Power Teams Chart for Availability)  |
| N.C.          |        | LB4 4.3 Liter (262 Cu In)--EFI V6   |
| N.C.          |        | L03 5.0 Liter (305 Cu In)--EFI V8   |
| 575.00        |        | w/R9A   |
|               |        | w/o R9A   |
| 270.00        |        | L05 5.7 Liter (350 Cu In)--EFI V8   |
| 845.00        |        | w/R9A   |
| 36.00         |        | w/o R9A   |
| N.C.          |        | UF2 <b>LAMPS:</b> Cargo Area  |
| N.C.          |        | VK3 <b>LICENSE PLATE BRACKET:</b> Front   |
| N.C.          | 1      | TR9 <b>LIGHTING, AUXILIARY:</b> (Incls Dome and Reading Lamps, Ashtray, Glovebox and Underhood Lamps)   |
| N.C.          |        | ZY1 <b>PAINT, EXTERIOR:</b> Solid (Refer Color/Trim Chart for Availability)   |
| N.C.          |        | R8T <b>PRICED ORDER ACKNOWLEDGEMENT</b>   |
|               |        | <b>RADIO EQUIPMENT:</b> (Incls Fixed Mast Antenna)  |
| N.C.          | 1      | UM6 Electronically Tuned AM/FM Stereo Radio w/Seek-Scan, Stereo Cassette Tape and Digital Clock   |
| 150.00        |        | UX1 Electronically Tuned AM Stereo/FM Stereo Radio w/Seek-Scan, Stereo Cassette Tape w/Search and Repeat, Graphic Equalizer and Digital Clock |
|               |        | F51 <b>SHOCK ABSORBERS:</b> Front and Rear, Heavy Duty (N/A Z71 Off-Road Chassis or ZQ8 Sport Chassis)  |
| N.C.          |        | w/R9A   |
| 40.00         |        | w/o R9A   |
|               |        | <b>SEAT TRIM:</b> (Refer Color/Trim Chart for Availability)   |
| N.C.          |        | X**1 Custom Vinyl Bench Seat  |
| 289.00        |        | X**2 Custom Vinyl Reclining Low Back Bucket Seats   |
| 174.00        |        | X**3 Custom Vinyl Reclining Split Bench Seat  |
| N.C.          |        | L**1 Custom Cloth Bench Seat  |
| 174.00        |        | L**3 Custom Cloth Reclining Split Bench Seat  |
| 490.00        |        | L**6 Custom Cloth Reclining High Back Bucket Seats  |
|               |        | NZZ <b>SKID PLATE:</b> Off-Road (K10703 Only) (Incl w/Z71 Off-Road Chassis)   |
| N.C.          |        | w/R9A   |
| 95.00         |        | w/o R9A   |
| N.C.          | 1      | BYP <b>SPORT PACKAGE:</b> Refer Standard Features Page for Option Content   |
| 59.00         |        | U16 <b>TACHOMETER</b>   |

**C/K 1500 MANUAL TRANSMISSION BONUS PACKAGE**

**When a Manual Transmission is Specified on The Order, One of The Option Groups Listed Below Must be Selected in Addition to The PEG. Refer Custom Ordering Options for Restrictions.**

- R9A  
 WORK PACKAGE**  
**KC4** - Engine Oil Cooler  
**F51** - Shock Absorbers (A)  
**NZZ** - Skid Plate (K1500 Only) (B)  
**L03** - 5.0L V8 (C)  
**A28** - Sliding Rear Window

- R9C  
 CONVENIENCE PACKAGE**  
**ZQ2** - Convenience Group: Power Door Locks and Power Windows  
**ZQ3** - Convenience Group: Comfortilt Steering and Speed Control  
**UM6** - Stereo Cassette w/Clock (D)

**R9D  
 BONUS PACKAGE DELETE**  
 Manual Transmission Bonus Package Not Desired

Allowable Substitutions (Where Available):

- (A) F51: May substitute Z71 Off-Road Chassis or ZQ8 Sport Chassis
- (B) NZZ: May substitute Z71 Off-Road Chassis
- (C) L03: May substitute L05 5.7L V8 Engine. Refer Power Team Chart
- (D) UM6: May substitute UX1 Stereo Radio

**\*MANUAL TRANSMISSION BONUS PACKAGE PRICES**

| <u>BONUS PKG</u>             | <u>BONUS PKG<br/>MSRP</u> |
|------------------------------|---------------------------|
| <b>R9A</b>                   |                           |
| C1500                        | 863.00                    |
| K1500                        | 958.00                    |
| <b>R9A BONUS PKG SAVINGS</b> | (-500.00)                 |
| <b>R9C</b>                   | N.C.                      |
| <b>R9C BONUS PKG SAVINGS</b> | (-500.00)                 |

**\*BONUS Package Prices shown do not include Preferred Equipment Group Prices or Discounts, Upgrades or Substitutions.**

**PREFERRED VEHICLE**  
**No Deletions Allowed, Additional Options/Substitutions (Where Indicated)**  
**May be Ordered from the Custom Ordering Option Listing**

**MUST SPECIFY:**

**EMISSION, TRANSMISSION, AXLE AND TIRES**

**SILVERADO**

P  
S  
P  
1

|                    |  |     |   |
|--------------------|--|-----|---|
|                    | <b>Preferred Equipment Group 1</b>                           |     |   |
|                    | <b>C10703</b>  |     |   |
| <b>*2638.00</b>    | <b>w/ZQ8</b>   |     |   |
| <b>*3018.00</b>    | <b>w/o ZQ8</b>   |     |   |
| <b>*3160.00</b>    | <b>K10703</b>  |     |   |
| <b>**(-800.00)</b> | <b>PEG 1 Savings</b>   |     |   |
|                    | Sport Package .....  | BYP | x |
|                    | Silverado Decor .....  | YE9 | x |
|                    | Air Conditioning .....                                       | C60 | x |
|                    | Body: Sportside .....  | E62 | x |
|                    | Convenience Group: Power Door Locks and Windows .....        | ZQ2 | x |
|                    | Convenience Group: Comfortit Steering and Speed Control .... | ZQ3 | x |
|                    | Lighting, Auxiliary .....                                    | TR9 | x |
|                    | Radio: AM/FM Stereo w/Tape and Clock (A) .....               | UM6 | x |

\*The Preferred Equipment Group MSRP's Reflect the Basic Group Equipment Prices. For any Option Additions, Upgrades, or Substitutions, Refer to the Vehicle Price Schedule for any Price Differential.  
 \*\* PEG Savings Amount represents the savings for Preferred Equipment Groups.

Allowable Substitutions (Where Available):  
 (A) UM6: May substitute UX1 Stereo Radio

**MODEL AND BODY**

|           | Description         | Model No | Body |
|-----------|---------------------|----------|------|
|           | 2-WHEEL-DRIVE MODEL |          |      |
| 14,580.00 | Sportside .....     | CC10703  | E62  |

|           | Description         | Model No | Body |
|-----------|---------------------|----------|------|
|           | 4-WHEEL-DRIVE MODEL |          |      |
| 16,830.00 | Sportside .....     | CK10703  | E62  |

**REFER POWER TEAM CHART (Pages 24 and 25) FOR ENGINE, TRANSMISSION and AXLE AVAILABILITY AND (Page 23) FOR GVWR SELECTOR AND CAPACITIES**

**TIRES: Must Specify Front, Rear and Spare**

| Description                         | Highway |      | On-Off Road |      |       |
|-------------------------------------|---------|------|-------------|------|-------|
|                                     | Front   | Rear | Front       | Rear | Spare |
| <b>TUBELESS Steel Belted Radial</b> |         |      |             |      |       |
| (a) P235/75R15 B/W                  | XFL     | YFL  |             |      | ZFL   |
| (b) LT265/75R16-C B/W               |         |      | XGL         | YGL  | ZGL   |
| (c) P275/60R15 B/W                  | XCN     | YCN  |             |      | ZCN   |

- (a)C10703 Only
  - (b)K10703 Only; w/LB4 or L03 Reqs 3.73 Axle Ratio
  - (c)C10703 Only; Reqs ZQ8 Sport Chassis
- B/W = Blackwall

**MODELS**

|   |   |
|---|---|
| Sportside 2-wheel drive (CC10703) ..... | 3 |
| Sportside 4-wheel drive (CK10703) ..... | 3 |

**DIMENSIONS**

|                                 |         |
|---------------------------------|---------|
| Wheelbase (inches) .....        | 117.5   |
| Cab-Axle (inches) .....         | 41.8    |
| Length (overall - inches) ..... | 194.0   |
| Width (overall-inches) .....    | 77.1    |
| <b>Box Size</b>                 |         |
| Length (overall - inches) ..... | 78.7    |
| Box Depth (inches) .....        | 19.3    |
| <b>Payload (pounds)</b>         |         |
| CC10703 .....                   | 1872    |
| CK10703 .....                   | 1935    |
| <b>GVWR</b>                     |         |
| CC10703 .....                   | 5600    |
| CK10703 .....                   | 6100    |
| <b>Fuel Tank Capacity</b> ..... | 25 Gal. |

**POWER TEAMS**

|   |      |
|---|------|
| <b>Standard Engine</b>  |      |
| RPO LB4 4.3 Liter (262 Cu In) V6 with Electronic Fuel Injection (EFI) |      |
| <b>Standard Transmission</b>  |      |
| RPO MM5 5-Speed Manual  |      |
| <b>Standard Rear Axle Ratio</b>                                       |      |
| CC10703 .....   | 3.08 |
| CK10703 .....   | 3.73 |

**STANDARD EQUIPMENT SUMMARY**

**EXTERIOR**

Air Dam:  
    CC10703 Black with fog lamps  
    CK10703 Black with tow hooks  
Brakes: Power assisted front disc, rear drum. Rear wheel anti-lock  
Bumper: Color-keyed front and rear bumper w/step pad  
Decal: Chevrolet on tailgate  
Grille: Color-keyed grille with gold bowtie  
Headlamps: Single rectangular halogen  
Horn: Dual low and high note electric  
Mirrors: Color-keyed RH and LH fixed with adjustable heads (6" x 4.5")  
Tires:  
    CC10703-P235/75R15 All Seasons Steel Belted Radial Ply B/W  
    CK10703-LT265/75R16C On-Off Road B/W  
Wheels: Aluminum without ZQ8 Chassis Equipment  
Windshield Wipers: Intermittent

**INTERIOR**

Cigarette Lighter  
Cupholders, under dash with bench seat  
Decor: Silverado  
Floor Covering: Color-keyed carpeting  
Floor Mats: Front removable color-keyed floor mats  
Gages: Including fuel level, odometer, oil pressure, speedometer, telltale lights, temperature and voltmeter  
Glass: Tinted, Solar-Ray, all windows  
Glove Box: Latched door and beverage holder  
Headliner: Color-keyed cloth including matching retainer moldings  
Heater: Deluxe heater with windshield and side window defoggers  
Mirrors: 10-inch rearview mirror  
Radio: Electronically-tuned AM/FM stereo with seek-scan and digital clock  
Scotchgard™ Fabric Protector on cloth trim and door panels  
Seats: Choice of custom vinyl or custom cloth front bench seat with folding backrest. Optional bucket seats include console  
Steering Wheel, Sport  
Storage Tray: Full width storage tray behind seat on floor  
Sunshades: Cloth covered with storage strap on LH unit and visor mirror on RH unit

**C1500 454SS PICKUP  
 INTERIOR AND EXTERIOR COLOR AVAILABILITY CHART  
 WITH ZY1 PAINT**

PLEASE NOTE: Below are the interior trim color and exterior paint combinations recommended by Chevrolet. They are the only available interior and exterior combinations allowed.

| TRIM LEVEL  |              | Decor        | INTERIOR COLORS  |      |        |      |
|---|--------------|--------------|--|------|--------|------|
| Seat Type   |              |              | Beige  | Blue | Garnet | Gray |
| SILVERADO<br>Custom Cloth Reclining-High Back<br>Bucket Seats |              | YE9          | LUU6   | LDD6 | LRR6   | LQQ6 |
| EXTERIOR COLORS   | Color Code 1 | Color Code 2 | INTERIOR & EXTERIOR COMBINATIONS SHOWN ARE THE ONLY COMBINATIONS AVAILABLE |      |        |      |
| BLACK, ONYX   | 41           | 41           | x  |      | x      | x    |
| RED, VICTORY  | 74           | 74           | x  |      | x      | x    |
| WHITE, SUMMIT   | 50           | 50           | x  | x    | x      | x    |

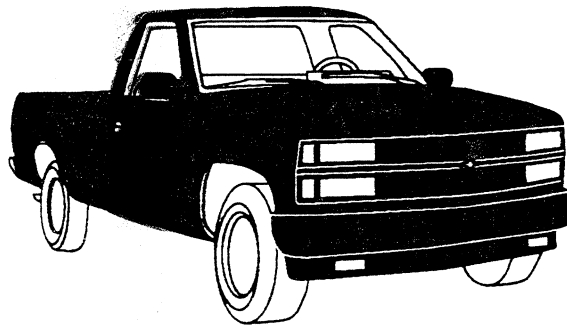

**SOLID PAINT - ZY1**

**PREFERRED VEHICLE**

No Deletions Allowed. Additional Options  
 May be Ordered from the Custom Ordering Option Listing

**MUST SPECIFY:**

**EMISSION, L19 ENGINE, MX0 TRANSMISSION,  
 GQ1 AXLE AND X, Y, ZCN TIRES**

|      |                                    | SILVERADO |
|------|------------------------------------|-----------|
|      |                                    | P         |
|      |                                    | S         |
|      |                                    | S         |
|      |                                    | 1         |
| N.C. | <b>Preferred Equipment Group 1</b> |           |
|      | 454SS Package .....                | B4U x     |
|      | Body Code .....                    | E63 x     |
|      | Silverado Decor .....              | YE9 x     |

**CUSTOM ORDERING OPTIONS**

PLEASE REVIEW OPTION RESTRICTIONS BEFORE ORDERING

| INCL<br>w/PEG | OPTION |  |
|---------------|--------|--|
|               | 1      | B4U <b>454SS PACKAGE:</b> (Refer Standard Features Page for Package Content)                 |
| N.C.          |        | GQ1 <b>AXLE:</b> Base  |
| 225.00        |        | BZY <b>BEDLINER:</b> Under Rail  |
| N.C.          | 1      | E63 <b>BODY:</b> Fleetside, 6-1/2 Ft.  |
|               |        | <b>EMISSIONS:</b>  |
| N.C.          |        | NA5 Standard Emission Equipment  |
| N.C.          |        | NA6 High Altitude Emission Requirement   |
| 100.00        |        | YF5 California Emission Requirements   |
| N.C.          |        | L19 <b>ENGINE:</b> 7.4 Liter (454 Cu In) V8  |
| N.C.          |        | VK3 <b>LICENSE PLATE BRACKET:</b> Front  |
| N.C.          |        | ZY1 <b>PAINT, EXTERIOR:</b> Solid (Refer Color/Trim Chart for Availability)                  |
| N.C.          |        | R8T <b>PRICED ORDER ACKNOWLEDGEMENT</b>  |
|               |        | <b>SEAT TRIM:</b> (Refer Color/Trim Chart for Availability)                                  |
| N.C.          |        | L**6 Custom Cloth Reclining High Back Bucket   |
|               |        | <b>TIRES:</b> Tubeless (Must Specify)  |
|               |        | Steel Belted Radial Highway (BW=Blackwall)   |
| N.C.          |        | XCN P275/60R15 B/W, Front  |
| N.C.          |        | YCN P275/60R15 B/W, Rear   |
| N.C.          |        | ZCN P275/60R15 B/W, Spare  |
| N.C.          |        | MX0 <b>TRANSMISSION:</b> 4-Speed Electronically Controlled Automatic w/Overdrive, Heavy-Duty |



**MODEL AND BODY**

|           | Description                      | Model No | Body      |
|-----------|----------------------------------|----------|-----------|
| 21,835.00 | 2-WHEEL-DRIVE MODEL<br>Fleetside | CC10703  | E63 & B4U |

**GVWR SELECTOR**

| GVW Rating<br>(lbs) | GAWR  |      | Minimum Equipment Required for GVW Rating |
|---------------------|-------|------|---|
|                     | Front | Rear |   |
| 5600                | 3150  | 3404 | Reqs B4U                                  |

**CAPACITIES**

| SPRINGS: |      | AXLES: |      |
|----------|------|--------|------|
| Front    | 3150 | Front  | 3150 |
| Rear     | 3750 | Rear   | 3404 |

**EMISSIONS (Must Specify One)**

NA5 Standard Emission Equipment  
NA6 High Altitude Emission Equipment  
YF5 California Emission Requirements

**POWER TEAMS (Must Specify Engine, Transmission and Rear Axle)**

(Consult GVWR Selector For Minimum Equipment Required)

| ENGINE   | TRANSMISSION | AXLE | GVWR |
|--|--------------|------|------|
|  | AUTO         | 4.10 |      |
| <b>W/NA5 STANDARD, NA6 HIGH ALTITUDE OR YF5 CALIFORNIA EMISSIONS</b> |              |      |      |
| L19 V8 7.4 Liter<br>(454 Cu In)--EFI                                 | MX0          | GQ1  | 5600 |

**TIRES: Must Specify Front, Rear and Spare**

| Description                         | Highway |      | Spare |
|-------------------------------------|---------|------|-------|
|                                     | Front   | Rear |       |
| <b>TUBELESS Steel Belted Radial</b> |         |      |       |
| P275/60R15 B/W                      | XCN     | YCN  | ZCN   |

B/W = Blackwall

**MODELS PASSENGERS**

Fleetside 2-wheel drive (CC10703) ..... 2

**DIMENSIONS**

Wheelbase (inches) ..... 117.5  
 Cab-Axle (inches) ..... 41.8  
 Length (overall - inches) ..... 194.0  
 Width (overall-inches) ..... 76.8  
 Box Size  
     Length (overall - inches) ..... 78.7  
 Box Depth (inches) ..... 19.3  
 Payload (pounds) ..... 1603  
 GVWR ..... 5600  
 Fuel Tank Capacity ..... 25 Gal.

**POWER TEAMS**

Standard Engine  
     RPO L19 7.4 Liter (454 Cu In) V8 with Electronic Fuel  
     Injection (EFI)  
 Standard Transmission  
     RPO MX0 4-speed Electronically Controlled Automatic  
     with Overdrive, H.D.  
 Standard Rear Axle Ratio ..... 4.10  
 Standard Rear Locking Differential

**STANDARD EQUIPMENT SUMMARY**

**EXTERIOR**

Air Dam: Black with fog lamps  
 Brakes: Power assisted front disc, rear drum. Rear wheel  
     anti-lock  
 Bumper: Black front and rear bumper with rub strips  
 Cooler: Engine oil cooler  
 Cooling: Heavy-Duty cooling  
 Decals: 454 SS Identification decals  
 Grille: Black with red bowtie  
 Headlamps: Dual composite halogen  
 Horn: Dual low and high note electric  
 Mirrors: RH and LH fixed exterior rear view mirrors with  
     adjustable heads (6" x 4.5")  
 Molding: Special body side moldings, black  
 Tires: P275/60R15 All Seasons Steel Belted Radial  
     Ply B/W  
 Wheels: Chrome plated 15-inch wheels  
 Wheel: Spare wheel and tire  
 Windshield Wipers: Intermittent

**INTERIOR**

Air Conditioning  
 Auxiliary Lighting: Dome and reading lamps, courtesy  
     lamps, ashtray lamp, glove box lamp, cargo area lamp,  
     underhood lamps and RH and LH door jamb switches  
 Cigarette Lighter  
 Comfortilt Steering  
 Decor: Silverado  
 Electronic Speed Control  
 Floor Covering: Color-keyed carpeting  
 Floor Mats: Front removable color-keyed  
 Gages, Analog: Including fuel level, odometer, oil  
     pressure, speedometer, tachometer, telltale lights,  
     temperature and voltmeter  
 Glass: Tinted, Solar-Ray, all windows  
 Glove Box: Latched door and beverage holder  
 Headliner: Color-keyed cloth headliner including matching  
     retainer moldings  
 Heater: Deluxe heater with windshield and side  
     window defoggers  
 Mirrors: 10-inch rearview mirror  
 Power Door Locks  
 Power Windows  
 Radio: Electronically tuned AM stereo/FM stereo with  
     fixed mast antenna, seek- scan, stereo cassette tape  
     with search and repeat graphic equalizer and digital  
     clock with fixed mast antenna  
 Scotchgard™ Fabric Protector on cloth trim and door  
     panels  
 Seats: High-back reclining front bucket seats with  
     console and inboard armrest  
 Steering Wheel: Sport urethane 4-spoke steering wheel  
 Sunshades: Cloth covered with storage strap on LH unit  
     and visor mirror on RH unit  
 Windows: Sliding rear window



**W/T1500 WORK TRUCK PICKUP  
INTERIOR AND EXTERIOR COLOR AVAILABILITY CHART  
WITH ZY1 PAINT**

**PLEASE NOTE:** Below are the interior trim color and exterior paint combinations recommended by Chevrolet. They are the only available interior and exterior combinations allowed.

| TRIM LEVEL       |  | Decor | INTERIOR COLORS |      |        |      |
|------------------|--|-------|-----------------|------|--------|------|
| Seat Type        |  |       | Beige           | Blue | Garnet | Gray |
| CHEYENNE         |  | Std   |                 |      |        |      |
| Vinyl Bench Seat |  |       | VUU1            | VDD1 | VRR1   | VQQ1 |
| Cloth Bench Seat |  |       | CUU1            | CDD1 | CRR1   | CQQ1 |

| EXTERIOR COLORS       | Color Code 1  | Color Code 2  | INTERIOR & EXTERIOR COMBINATIONS SHOWN ARE THE ONLY COMBINATIONS AVAILABLE |      |              |      |
|-----------------------|---------------|---------------|--|------|--------------|------|
|                       |               |               | Beige  | Blue | Garnet       | Gray |
| BEIGE, SAND (Met)     | 57            | 57            | x  |      |              |      |
| BLACK, ONYX           | 41            | 41            | x  |      | x            | x    |
| BLUE, INDIGO (Met)    | 39            | 39            | x  | x    |              |      |
| BLUE, LT QUASAR (Met) | 20            | 20            |  | x    |              | x    |
| GREEN, TEAL (Met)     | <del>84</del> | <del>84</del> | x  |      | <del>x</del> | x    |
| QUICKSILVER (Met)     | 96            | 96            |  | x    | x            | x    |
| RED, VICTORY          | 74            | 74            | x  |      | x            | x    |
| SLATE (Met)           | 97            | 97            |  |      | x            | x    |
| WHITE, SUMMIT         | 50            | 50            | x  | x    | x            | x    |

*Handwritten note: Garnet*

*Handwritten note: 84 84 x*

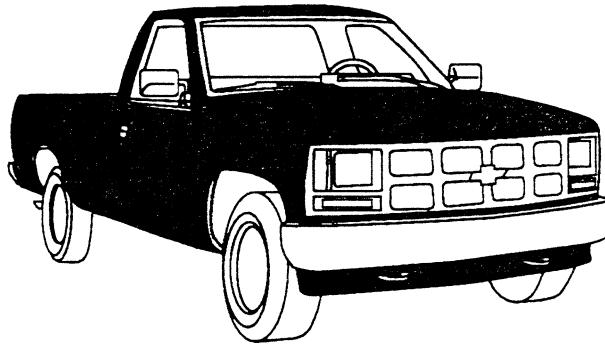

**SOLID PAINT - ZY1**

**CUSTOM ORDERING OPTIONS**  
**PLEASE REVIEW OPTION RESTRICTIONS BEFORE ORDERING**

| <b>INCL<br/>w/PEG</b> | <b>OPTION</b> |   |
|-----------------------|---------------|---|
|                       |               | <b>TIRES: Tubeless, Steel Belted Radial (Refer Tire Chart for Availability)</b> |
|                       |               | Front   |
| N.C.                  | XET           | P225/75R15 B/W Highway (C10903 Only)  |
| 28.00                 | XFL           | P235/75R15 B/W Highway (C10903 Only)  |
| N.C.                  | XHE           | LT225/75R16-C B/W Highway (K10903 Only)   |
| 22.00                 | XHJ           | LT225/75R16-C B/W On-Off Road (K10903 Only)                                     |
|                       |               | Rear  |
| N.C.                  | YET           | P225/75R15 B/W Highway (C10903 Only)  |
| 28.00                 | YFL           | P235/75R15 B/W Highway (C10903 Only)  |
| N.C.                  | YHE           | LT225/75R16-C B/W Highway (K10903 Only)   |
| 22.00                 | YHJ           | LT225/75R16-C B/W On-Off Road (K10903 Only)                                     |
|                       |               | Spare   |
|                       | ZET           | P225/75R15 B/W Highway (C10903 Only)<br>w/PWT2<br>w/PWT1                        |
| N.C.                  |               |   |
| 160.00                | ZFL           | P235/75R15 B/W Highway (C10903 Only)<br>w/PWT2<br>w/PWT1                        |
| 14.00                 |               |   |
| 174.00                | ZHE           | LT225/75R16-C B/W Highway (K10903 Only)<br>w/PWT2<br>w/PWT1                     |
| N.C.                  |               |   |
| 221.00                | ZHJ           | LT225/75R16-C B/W On-Off Road (K10903 Only)<br>w/PWT2<br>w/PWT1                 |
| 11.00                 |               |   |
| 232.00                |               |   |
| 38.00                 | V76           | <b>TOW HOOKS:</b> Two Front (Standard on K10903)                                |
|                       |               | <b>TRANSMISSIONS:</b> (Refer Power Teams Chart for Availability)                |
| N.C.                  | 1,2           | MM5 5-Speed Manual with Overdrive   |
| 98.00                 |               | MT8 5-Speed Manual with Deep Low and Overdrive, Heavy-Duty                      |
| 890.00                |               | MX0 4-Speed Electronically Controlled Automatic with Overdrive                  |
|                       |               | <b>WHEEL TRIM:</b>  |
| 42.00                 |               | P01 Wheel Covers  |
| 60.00                 |               | P06 Rally Wheel Trim  |
|                       | 2             | A28 <b>WINDOW:</b> Sliding Rear   |
| N.C.                  |               | w/PWT2  |
| 113.00                |               | w/PWT1  |

**CUSTOM ORDERING OPTIONS**  
**PLEASE REVIEW OPTION RESTRICTIONS BEFORE ORDERING**

|        | <b>INCL<br/>w/PEG</b> | <b>OPTION</b> |   |
|--------|-----------------------|---------------|---|
| 805.00 |                       | C60           | <b>AIR CONDITIONING</b>   |
| N.C.   |                       | GQ1           | <b>AXLES, REAR:</b> (Refer Power Teams Chart for Availability)  |
| 44.00  |                       | ---           | Base  |
| 252.00 |                       | G80           | Optional  |
| N.C.   | 2                     | BZY           | Locking Differential (N/A 3.08 Axle on C10903)  |
| 225.00 |                       |               | <b>BEDLINER:</b> Under Rail   |
| N.C.   |                       |               | w/PWT2  |
| 25.00  |                       |               | w/PWT1  |
| N.C.   | 1,2                   | E63           | <b>BODY CODE:</b> 8 Ft. Fleetside   |
| 130.00 | 2                     | V43           | <b>BUMPER:</b> Painted, Rear Step   |
| 33.00  |                       |               | w/PWT2  |
|        |                       |               | w/PWT1  |
|        |                       | V10           | <b>COLD-CLIMATE PACKAGE:</b> (Incls Eng Block Heater)   |
| 135.00 |                       | KC4           | <b>COOLING SYSTEM:</b>  |
| 56.00  |                       | V01           | Engine Oil (w/MX0Trans Reqs V02 Cooling)  |
| 63.00  |                       | V02           | Radiator, Heavy-Duty (N/A C60 Air or V02 Cooling)   |
|        |                       |               | Radiator and Trans Oil, Heavy-Duty (Reqs MX0 Trans) (w/C60 Air Reqs KC4 Cooling)  |
|        |                       |               | (N/A V01 Cooling)   |
| N.C.   |                       | NA5           | <b>EMISSIONS:</b>   |
| N.C.   |                       | NA6           | Standard Emission Equipment   |
| 100.00 |                       | YF5           | High Altitude Emission Requirement  |
| N.C.   |                       | LB4           | California Emission Requirements  |
| 36.00  |                       | UF2           | <b>ENGINE:</b> 4.3 Liter (262 Cu In)--EFI V6 (Refer Power Teams Chart for Availability)   |
| N.C.   |                       | VK3           | <b>LAMPS:</b> Cargo Area  |
| N.C.   |                       | ZY1           | <b>LICENSE PLATE BRACKET:</b> Front   |
| N.C.   |                       | R8T           | <b>PAINTE, EXTERIOR:</b> Solid (Refer Color/Trim Chart for Availability)  |
|        |                       |               | <b>PRICED ORDER ACKNOWLEDGEMENT</b>   |
|        | 2                     | UP4           | <b>RADIO EQUIPMENT:</b> (Incls Fixed Mast Antenna)  |
| N.C.   |                       |               | Electronically Tuned AM Radio   |
| 162.00 |                       |               | w/PWT2  |
|        |                       |               | w/PWT1  |
| 170.00 |                       | UM7           | Electronically Tuned AM/FM Stereo Radio w/Seek-Scan and Digital Clock   |
| 332.00 |                       |               | w/PWT2  |
|        |                       |               | w/PWT1  |
| 292.00 |                       | UM6           | Electronically Tuned AM/FM Stereo Radio w/Seek-Scan, Stereo Cassette Tape and Digital Clock   |
| 454.00 |                       |               | w/PWT2  |
|        |                       |               | w/PWT1  |
|        |                       | UX1           | Electronically Tuned AM Stereo/FM Stereo Radio w/Seek-Scan, Stereo Cassette Tape w/Search and Repeat, Graphic Equalizer and Digital Clock |
| 442.00 |                       |               | w/PWT2  |
| 604.00 |                       |               | w/PWT1  |
|        |                       |               | <b>SEAT TRIM:</b> (Refer Color/Trim Chart for Availability)   |
| N.C.   |                       | V**1          | Vinyl Bench Seat  |
| N.C.   |                       | C**1          | Cloth Bench Seat  |
|        |                       | F51           | <b>SHOCK ABSORBERS:</b> Front and Rear, Heavy Duty (Incl w/VYU Snow Plow Pkg)   |
| N.C.   |                       |               | w/VYU   |
| 40.00  |                       |               | w/o VYU   |
| 95.00  |                       | NZZ           | <b>SKID PLATE:</b> Off-Road (K10903 Only)   |
|        |                       | VYU           | <b>SNOW PLOW PREP PACKAGE:</b> (K10903) (Reqs KC4 Cooling)  |
|        |                       |               | (Incls F60 Front Springs and F51 H.D. Shock Absorbers)  |
| 253.00 |                       |               | w/PWT2  |
| 293.00 |                       |               | w/PWT1  |
|        |                       | F60           | <b>SPRINGS, FRONT:</b> Heavy Duty (K10903 Only) (Incl w/VYU Snow Plow)  |
| N.C.   |                       |               | w/VYU   |
| 63.00  |                       |               | w/o VYU   |

**VLA WORK TRUCK PACKAGE INCLUDES:**

(Incls Dark Argent Painted Front Appearance, Front Bumper and Air Dam)  
 (Reqs LB4 Eng, Solid Paint and Standard Interior w/Bench Seat) (C-K10903 Only)

**PREFERRED VEHICLE**  
**No Deletions Allowed, Additional Options/Upgrades (Where Indicated)**  
**May be Ordered from the Custom Ordering Option Listing**

**MUST SPECIFY:**

**EMISSION, TRANSMISSION, AXLE AND TIRES**

|             |                                    |     | <b>CHEYENNE</b> |          |
|-------------|------------------------------------|-----|-----------------|----------|
|             |                                    |     | <b>P</b>        | <b>P</b> |
|             |                                    |     | <b>W</b>        | <b>W</b> |
|             |                                    |     | <b>T</b>        | <b>T</b> |
|             |                                    |     | <b>1</b>        | <b>2</b> |
| N.C.        | <b>Preferred Equipment Group 1</b> |     |                 |          |
|             | Work Truck Package .....           | VLA | x               | x        |
|             | Body: Fleetside .....              | E63 | x               | x        |
| <hr/>       |                                    |     |                 |          |
|             | <b>Preferred Equipment Group 2</b> |     |                 |          |
| *790.00     | C10903                             |     |                 |          |
| *851.00     | K10903                             |     |                 |          |
| **(-500.00) | <b>PEG 2 Savings</b>               |     |                 |          |
|             | Bedliner: Under Rail .....         | BZY |                 | x        |
|             | Bumper, Rear Step .....            | V43 |                 | x        |
|             | Radio: ETR AM Radio (A) .....      | UP4 |                 | x        |
|             | Tire, Spare .....                  | Z** |                 | x        |
|             | Window, Sliding Rear .....         | A28 |                 | x        |

\* The Preferred Equipment Group MSRPs Reflect the Basic Group Equipment Prices. For any Option Additions, Upgrades or Substitutions, Refer to the Vehicle Price Schedule for any Price Differential.

\*\* PEG Savings Amount represents the savings for Preferred Equipment Groups.

Allowable Substitutions (Where Available):

(A) UP4: May substitute UM7, UM6 or UX1 Radio

### EMISSIONS (Must Specify One)

NA5 Standard Emission Equipment  
NA6 High Altitude Emission Equipment  
YF5 California Emission Requirements

### POWER TEAMS (Must Specify Engine, Transmission and Rear Axle)

(Consult GVWR Selector For Minimum Equipment Required)

| ENGINE                                   | TRANSMISSION |      | AXLES   |      |         | GVWR      |
|--|--------------|------|---------|------|---------|-----------|
|  | 5-SP         | AUTO | 3.08    | 3.42 | 3.73    |           |
| <b>W/NA5 STANDARD EMISSIONS</b>          |              |      |         |      |         |           |
| <b>C10903</b>                            |              |      |         |      |         |           |
| LB4 V6 4.3 Liter<br>(262 Cu In)--EFI     | MM5/MT8      | MX0  | (b) GQ1 | GU6  | ---     | 5600/6100 |
| <b>K10903</b>                            |              |      |         |      |         |           |
| LB4 V6 4.3 Liter<br>(262 Cu In)--EFI     | MM5          |      | ---     | ---  | (c) GT4 | 6100      |
|  | MT8          | MX0  | ---     | GQ1  | (a) GT4 | 6100      |
| <b>W/NA6 HIGH ALTITUDE EMISSIONS</b>     |              |      |         |      |         |           |
| <b>C10903</b>                            |              |      |         |      |         |           |
| LB4 V6 4.3 Liter<br>(262 Cu In)--EFI     | MM5/MT8      |      | (b) GQ1 | GU6  | ---     | 5600/6100 |
|  |              | MX0  | ---     | GQ1  | (a) GT4 | 5600/6100 |
| <b>K10903</b>                            |              |      |         |      |         |           |
| LB4 V6 4.3 Liter<br>(262 Cu In)--EFI/MT8 | MM5          |      | ---     | ---  | (c) GT4 | 6100      |
|  | MT8          | MX0  | ---     | GQ1  | (a) GT4 | 6100      |
| <b>W/YF5 CALIFORNIA EMISSIONS</b>        |              |      |         |      |         |           |
| <b>C10903</b>                            |              |      |         |      |         |           |
| LB4 V6 4.3 Liter<br>(262 Cu In)--EFI     | MM5/MT8      | MX0  | (b) GQ1 | GU6  | ---     | 5600/6100 |
| <b>K10903</b>                            |              |      |         |      |         |           |
| LB4 V6 4.3 Liter<br>(262 Cu In)--EFI     | MM5          |      | ---     | ---  | (c) GT4 | 6100      |
|  | MT8          | MX0  | ---     | GQ1  | (a) GT4 | 6100      |

- (a) Reqs KC4 Cooler; w/MX0 Also Reqs V02 H.D. Cooling  
(b) N/A G80 Differential  
(c) Reqs KC4 Cooler; Base at no charge, GQ1 will be added by system

### TIRES: Must Specify Front and Rear (Optional Spare Tire Available)

| Description                         | Highway |      | On-Off Road |      |       |
|-------------------------------------|---------|------|-------------|------|-------|
|                                     | Front   | Rear | Front       | Rear | Spare |
| <b>C10903 Models Only</b>           |         |      |             |      |       |
| <b>TUBELESS Steel Belted Radial</b> |         |      |             |      |       |
| P225/75R15 B/W                      | XET     | YET  |             |      | ZET   |
| P235/75R15 B/W                      | XFL     | YFL  |             |      | ZFL   |
| <b>K10903 Models Only</b>           |         |      |             |      |       |
| <b>TUBELESS Steel Belted Radial</b> |         |      |             |      |       |
| LT225/75R16-C B/W                   | XHE     | YHE  |             |      | ZHE   |
| LT225/75R16-C B/W                   |         |      | XHJ         | YHJ  | ZHJ   |

B/W = Blackwall

REVISED: 1-22-93

1993 ORDER GUIDE

C/K REGULAR CAB PICKUP

Prices Shown Are Manufacturer's Suggested Retail Prices (MSRP) At The Time Of Publication. These Prices Are To Be Used Only As An Aid To Inventory Management Since MSRP Figures Change Periodically. The Vehicle Price Schedule Is The Official Pricing Documentation Of Chevrolet Motor Division And Should Be Used In Discussing Vehicle Prices With Potential Buyers. The Model Prices Shown In The Order Guide Include The Destination Freight Charges.



**MODEL AND BODY**

| Description                                       | Model No | Body      |
|---|----------|-----------|
| 2-WHEEL-DRIVE MODEL                               |          |           |
| <del>11,850.00</del><br>12,805.00 Fleetside ..... | CC10903  | E63 & VLA |

| Description                                       | Model No | Body      |
|---|----------|-----------|
| 4-WHEEL-DRIVE MODEL                               |          |           |
| <del>15,900.00</del><br>15,425.00 Fleetside ..... | CK10903  | E63 & VLA |

**\*GVWR SELECTOR**

**Minimum Equipment Required for GVW Rating**

| GVW Rating (lbs) | GAWR* |      |                |
|------------------|-------|------|----------------|
|                  | Front | Rear |                |
| <b>C10903</b>    |       |      |                |
| 5600             | 2950  | 3404 | Reqs YET Tires |
| 6100             | 3150  | 3686 | Reqs YFL Tires |
| <b>K10903</b>    |       |      |                |
| 6100             | 3600  | 3750 |                |

\*GAWR's shown are the minimum for each axle with equipment listed. Other GAWR's are available, and they are determined as the minimum capacity of either axle, springs or tires.

**CAPACITIES**

| C10903          |      |             |
|-----------------|------|-------------|
| <b>SPRINGS:</b> |      |             |
| Front           | 2950 |             |
| Rear            | 3750 |             |
| <b>AXLES:</b>   |      |             |
| Front           | 3150 |             |
| Rear            | 3404 | Base        |
|                 | 3750 | w/6100 GVWR |

| K10903          |      |  |
|-----------------|------|--|
| <b>SPRINGS:</b> |      |  |
| Front           | 3600 |  |
| Rear            | 3750 |  |
| <b>AXLES:</b>   |      |  |
| Front           | 3925 |  |
| Rear            | 3750 |  |

Page 2  
 Prices Shown Are Manufacturer's Suggested Retail Prices (MSRP) At The Time Of Publication. These Prices Are To Be Used Only As An Aid To Inventory Management Since MSRP Figures Change Periodically. The Vehicle Price Schedule Is The Official Pricing Documentation Of Chevrolet Motor Division And Should Be Used In Discussing Vehicle Prices With Potential Buyers. The Model Prices Shown In The Order Guide Include The Destination Freight Charges.

**MODELS**

|   |   |
|---|---|
| Fleetside 2-wheel drive (CC10903) ..... | 3 |
| Fleetside 4-wheel drive (CK10903) ..... | 3 |

**DIMENSIONS**

|                                 |           |
|---------------------------------|-----------|
| Wheelbase (inches) .....        | 131.5     |
| Cab-Axle (inches) .....         | 55.9      |
| Length (overall - inches) ..... | 212.6     |
| Width (overall-inches) .....    | 76.8      |
| <b>Box Size</b>                 |           |
| Length (overall - inches) ..... | 97.6      |
| Box Depth (inches) .....        | 19.3      |
| <b>Payload (pounds)</b>         |           |
| CC10903 .....                   | 1766/2554 |
| CK10903 .....                   | 1340/1819 |
| <b>GVWR</b> .....               | 5600/6100 |
| <b>Fuel Tank Capacity</b> ..... | 34 Gal.   |

**POWER TEAMS**

|   |      |
|---|------|
| <b>Standard Engine</b>  |      |
| RPO LB4 4.3 Liter (262 Cu In) V6 with Electronic Fuel Injection (EFI) |      |
| <b>Standard Transmission</b>  |      |
| RPO MM5 5-Speed Manual  |      |
| <b>Standard Rear Axle Ratio</b>                                       |      |
| CC10903 .....   | 3.08 |
| CK10903 .....   | 3.42 |

**STANDARD EQUIPMENT SUMMARY**

**EXTERIOR**

Air Dam: Dark argent  
 Body Side Decals: W/T 1500 with integrated bow tie  
 Brakes: Power assisted front disc, rear drum. Rear-wheel anti-lock  
 Bumper: Dark argent metallic front bumper  
 Grille: Dark argent metallic, impact resistant  
 Mirrors: RH and LH below-eye-line, painted  
 Tires:  
     CC10903-P225/75R15 All Seasons Steel Belted Radial Ply B/W  
     CK10903-LT225/75R16C All Seasons Steel Belted Radial Ply B/W  
 Tow Hooks: Two front tow hooks on 4-wheel drive model only  
 Wheels: Silver painted steel wheels with black hub ornament  
 Windshield Wipers: Intermittent

**INTERIOR**

Cigarette Lighter  
 Cupholders, under dash  
 Dome Lamp: With switch in LH and RH door jamb  
 Floor Covering: Embossed black rubber mat  
 Gages: Including fuel level, odometer, oil pressure, speedometer, telltale lights, temperature and voltmeter  
 Glass: Tinted, Solar-Ray, all windows  
 Glove Box: Latched door and beverage holder  
 Headliner: Vinyl headliner with matching retainer moldings  
 Heater: Deluxe heater with windshield and side window defoggers  
 Mirrors: 10-inch rearview mirror  
 Scotchgard™ Fabric Protector on cloth trim and door panels  
 Seats: 3-passenger all-vinyl or cloth trim front bench seat with head restraints and folding backrest  
 Steering Wheel: Custom urethane 4-spoke steering wheel  
 Sunshade: Color-keyed vinyl RH and LH padded sunshade

# INDY TRUCK

## Eligible Models

CC10703 & CC10903 Fleetside Only (E63)

## Required Options

|                              |                  |
|------------------------------|------------------|
| PEG                          | P1A4             |
| Interior Trim                | LQQ3*            |
| Paint                        | ZY2              |
| Upper                        | 41               |
| Lower                        | 50               |
| Engine                       | LO5              |
| Transmission                 | MX0              |
| Emissions                    | NA5, NA6, or YF5 |
| Axle                         | GQ1*             |
| Chrome Wheels                | N83*             |
| Tires                        | XFL, YFL, & ZFL* |
| Ship Through Code            | VWF              |
| <b>Special Ordering Code</b> | <b>5S6</b>       |

The Special Ordering Code will **include** the Following Equipment:

- Body Colored Bumpers Front and Rear
- Black Grille with Red Bowtie
- Black Air Dam with Fog Lamps
- RH and LH Fixed Rear View Mirrors with Adjustable Head (not the Mirrors pictured)
- Special Five Color Graphic on Both Sides of the Truck and Hood (Following decals will be shipped separately for optional installation)
- Two Official Pace Truck Graphics
- Three Indianapolis Race Decals
- Three Indianapolis Wing Decals
- "Chevrolet" Windshield Decal

The following Equipment will be **Removed**:

- Body Side Moldings
- Wheel Opening Moldings

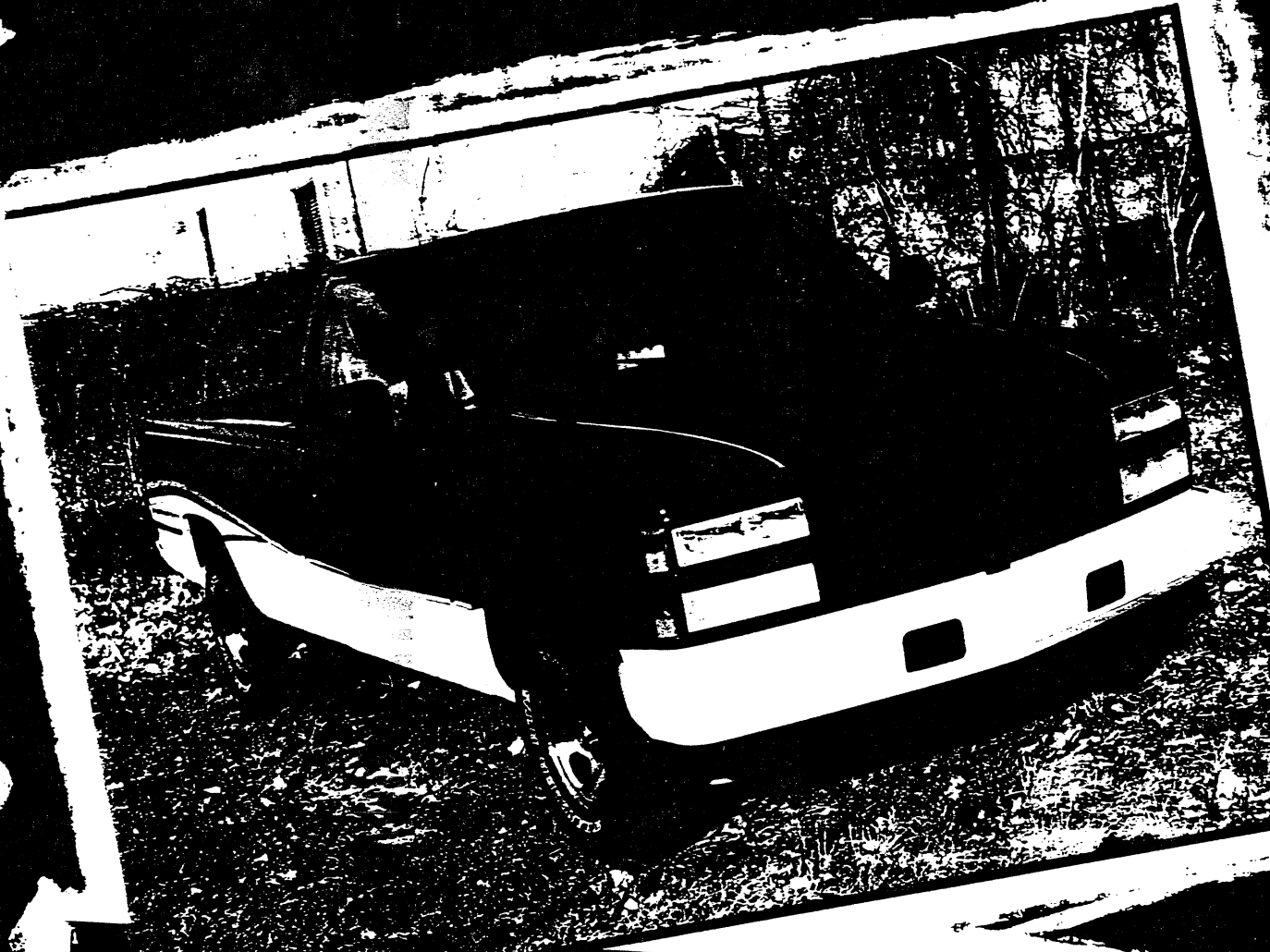

## Ordering Recommendations (continued)

The Full-Size C/K Pickup Focus vehicle in 1993 is the C1500 Fleetside Long-Box Silverado. This 2WD truck offers exceptional payload capacity, durability and driver comfort. It's a strong lead vehicle loaded with value at an affordable price.

### C/K CREW-CABS

Chevrolet Crew-Cabs, completely redesigned in 1992, utilize the proven C/K truck platform. They feature a rear-wheel anti-lock brake system and up to 10,000 lbs. towing capacity. Crew-Cab models, including Big Dooley, present an excellent opportunity to generate incremental sales in the commercial market.

### FOCUS PLANNING WITH RETAIL SALES ANALYSIS

Economic influences, fuel costs, seasonal changes and many other variable factors can influence truck customers. During the model year, you can "take the pulse" of buyers as required to determine what models, PEGs and colors are currently being most often chosen. To do this, Chevrolet Motor Division recommends that you utilize Retail Sales Analysis when ordering vehicles for inventory.

The RSA is found in the Chevrolet Dealer Information System (DCS/CDIS).

- ▶ Use RSA to identify which C/K models, PEGs and colors are selling at your dealership as well as other dealerships in your MDA, Sales Area, ADI, MSSA, Branch, SMA, and National.
- ▶ You can increase your turnover rate by using RSA to identify top-selling models and PEGs that you can focus on in your advertising and promotions.
- ▶ For more information about RSA, refer to your Chevrolet Dealer Information System (CDIS) Manual or contact your Account Manager - CMC.

## Preferred Equipment Groups

Popular C/K Pickup options are combined into convenient Preferred Equipment Groups. These equipment packages are designed to:

- ▶ Appeal to a broad base of your truck customers
- ▶ Make ordering easier
- ▶ Add value to vehicles and enhance trade-in value
- ▶ Enable you to make your inventory and sales strategies more responsive to your competition.

### RECOMMENDED 1993 C/K PICKUP FOCUS MODELS/PEG

Two 1993 C/K Focus model/PEG combinations are recommended by Chevrolet, as shown at right.

- ▶ For *price-conscious buyers*, order the C1500 Regular-Cab Cheyenne Fleetside Pickup with standard 4.3L V6 and 5-speed manual transmission, PEG 2 and R9C Manual Transmission Bonus Package.

- ▶ C1500 Regular-Cab Cheyenne Pickup with 4.3L V6, 5-Speed Manual Transmission, PEG 2 (P1A2) and Manual Transmission Bonus Package (R9C)  
Includes: ♦ Fleetside Body ♦ Cheyenne Decor ♦ Air Conditioning ♦ AM/FM Stereo with Cassette Tape Player ♦ Convenience Group: Comfortilt Steering Wheel and Speed Control.

- ▶ For *uplevel intenders*, stock the C1500 Regular-Cab Silverado Fleetside Pickup with optional 5.0L V8, 4-speed automatic overdrive transmission and PEG 4.

- ▶ C1500 Regular-Cab Silverado Pickup with optional L03 5.0L V8, MX0 4-Speed Automatic Overdrive Transmission and PEG 4 (P1A4)  
Includes: ♦ Fleetside Body ♦ Silverado Decor ♦ Air Conditioning ♦ AM/FM Stereo with Cassette Tape Player ♦ Auxiliary Lighting ♦ Stainless-Steel Below-Eyeline Mirrors ♦ Convenience Groups: Comfortilt Steering Wheel and Speed Control, Power Door Locks and Power Windows.

See Truck Order Guide for complete PEG availability, full content descriptions and allowable substitutions.

## Forecasted Percent of Mix — 1993 C/K Pickup and Crew-Cab Models

| SERIES   |        |
|----------|--------|
| C/K 1500 | 80.0%  |
| C/K 2500 | 15.0%  |
| C/K 3500 | 5.0%   |
| Total    | 100.0% |

| MODELS                 |        |
|------------------------|--------|
| Regular-Cab Sportside  | 5.0%   |
| Regular-Cab Short-Box  | 19.0%  |
| Regular-Cab Long-Box   | 35.0%  |
| Extended-Cab Short-Box | 33.0%  |
| Extended-Cab Long-Box  | 7.0%   |
| Crew-Cab Long-Box      | 0.6%   |
| Crew-Cab Big Dooley    | 0.4%   |
| Total                  | 100.0% |

| TRIM LEVELS |        |
|-------------|--------|
| W/T 1500    | 10.0%  |
| Cheyenne    | 10.0%  |
| Silverado   | 80.0%  |
| Total       | 100.0% |

| ENGINES           |        |
|-------------------|--------|
| 4.3L              | 25.0%  |
| 5.0L              | 10.0%  |
| 5.7L              | 57.0%  |
| 7.4L              | 2.5%   |
| 6.2L Diesel       | 0.3%   |
| 6.2L LD Diesel    | 0.2%   |
| 6.5L Turbo-Diesel | 5.0%   |
| Total             | 100.0% |

| TRANSMISSIONS |        |
|---------------|--------|
| MM5           | 24.0%  |
| MT8           | 8.0%   |
| MX0           | 68.0%  |
| Total         | 100.0% |

# '93



## C/K Pickup and Crew-Cab

### Popular Colors

Listed below are the most popular C/K Pickup colors, nationally, based on 1992 Model Year production volumes. NOTE: These colors are for reference only. Use RSA to identify the top-selling colors, by model, in your area.

| COLOR                   | PERCENT (%) |
|-------------------------|-------------|
| 50 - Summit White       | 19          |
| 74 - Victory Red        | 13          |
| 30 - Catalina Blue Met. | 11          |
| 94 - Crimson Red Met.   | 11          |

NOTE: New exterior colors for '93 C/K Pickups are:  
20 - Light Quasar Blue Met.  
38 - Teal Green Met.  
39 - Indigo Blue Met.  
84 - Dark Garnet Red Met.

Refer to the Truck Order Guide for option availability and application

### Key Value Features

- ▶ Wide, comfortable, foam-cushioned bench seats with outboard head restraints and folding seat-backs.
- ▶ Tough ladder-type frame with full-box-section front construction.
- ▶ Rugged double-wall construction pickup boxes with two-tier loading capabilities.
- ▶ Standard rear-wheel anti-lock brake system for more stable, smoother stops - empty or loaded. (Operates in 2WD mode only.)
- ▶ Generous use of two-side-galvanized steel body panels (except roof), including pickup box.
- ▶ "Shift-on-the-fly" Insta-Trac™ 4x4 system, standard on K Series models; allows driver to shift from 2WD to 4WD High and back without slowing down or stopping.
- ▶ Fully independent front suspension on all 2WD and 4x4 models.
- ▶ 6.5 Liter V8 Turbo-Diesel engine optional in C/K2500/3500 Regular-Cab and (new for '93) Extended-Cab and Crew-Cab models (2500 Series requires C6P).

### C/K Pickup Highlights

- ▶ Sportside Extended-Cab model available.
- ▶ Standard 1-ton 9000/9200-lb. GVWR with single rear wheels, provides a competitive single-rear-wheel 1-ton model.
- ▶ Optional high-back bucket seats - include inboard armrests in Regular-Cab and Extended-Cab models, dual armrest in Crew-Cab models, and lever-activated reclining feature and easy-entry feature on Extended-Cab models.
- ▶ Base analog gage cluster.
- ▶ Self-aligning steering wheel, designed to automatically align with driver's body in the event of a frontal collision to help reduce chest impact and injury.
- ▶ Seat contour and suspension designed for comfort and appearance.

### C/K CREW-CAB HIGHLIGHTS

- ▶ Crew-Cab models, including the Big Dooley, continue to feature the fresh C/K styling

and rugged C/K platform adapted in 1992. Roomier interiors with more comfortable seats were built into these new-generation Chevy trucks.

- ▶ Up to 10,000 lbs. towing capacity available.
- ▶ One new '93 exterior color is available for C/K Crew-Cab models: Indigo Blue Metallic - Code 39 replaces Brilliant Blue Metallic - Code 22.

### Crew-Cab improvements over pre-1992 models include:

- ▶ Standard rear-wheel anti-lock brake system.
- ▶ Standard independent front suspension (4x4 models also have torsion bar springs).
- ▶ Enhanced seating comfort and appearance.
- ▶ Longer wheelbase for smoother ride.
- ▶ More two-side-galvanized steel used in Crew-Cab body construction than in pre-1992 models.

### Positioning for '93

Built for rugged, tough use, the Chevy Full-Size Pickup works hard, plays hard and more than holds its own with Ford and Dodge in the personal-use or commercial sectors. The Chevy C/K is currently a leader in the full-size segment, reflecting consumer preferences for its durability, dependability and styling. A broad product lineup - including 1/2-, 3/4- and 1-ton models with a wide selection of trim

levels and payload/towing capacities - offers advanced design/technology features (including RWAL brakes). Crew-Cab models, the Sportside Extended-Cab model and the optional 6.5 Liter V8 Turbo-Diesel (now available in Regular-, Extended- and Crew-Cab models) offer even more ways to meet the needs of personal and commercial users.

### Ordering Recommendations

#### FEATURE AND FOCUS VEHICLES

The Feature vehicle for '93 is the K1500 Fleetside Long-Box 4x4 with top-of-the-line Silverado trim. This is the vehicle Chevrolet plans to highlight in advertising, merchandising and show and display activities during the 1993 model year. On-the-job value combined with personal comfort and style contribute to this

pickup's appeal. It combines rugged good looks, outstanding cab comfort and big-load capacity with the versatility of "shift-on-the-fly" Insta-Trac™ 4x4. The Silverado trim adds appealing appearance enhancements and trim details to an all-around tough, dependable pickup.

(Continued on next page.)

Vinyl seat trim available in Beige, Blue, Garnet or Gray ▼

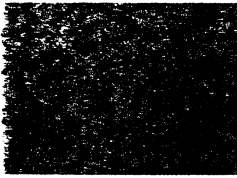

Vinyl bench seat for Cheyenne trim ▼

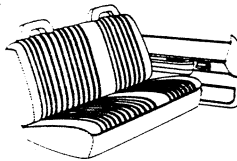

Vinyl 40/60 split-bench seat for Cheyenne trim ▼

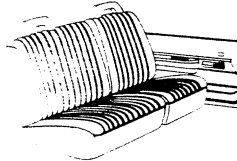

Vinyl low-back bucket seats ▼

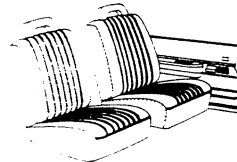

Cloth seat trim available in Beige, Blue, Garnet or Gray ▼



Cloth bench seat for Cheyenne trim ▼

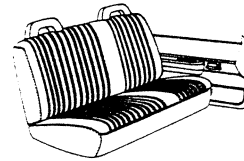

Cloth 40/60 split-bench seat for Cheyenne trim ▼

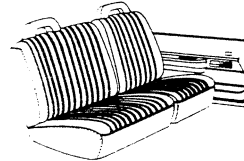

Cloth low-back bucket seat ▼

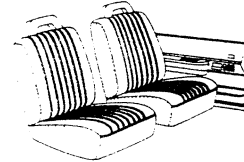

Custom Vinyl seat trim available in Beige, Blue, Garnet or Gray ▼



Custom Vinyl bench seat for Silverado trim ▼

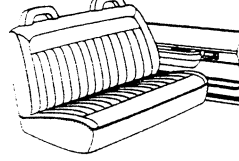

Custom Vinyl 40/60 split-bench seat for Silverado trim ▼

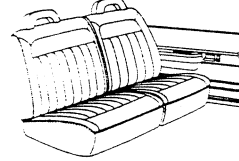

Custom Vinyl low-back bucket seats for Silverado trim ▼

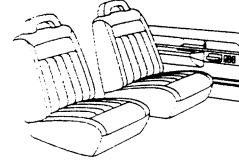

Custom Cloth seat trim available in Beige, Blue, Garnet or Gray ▼

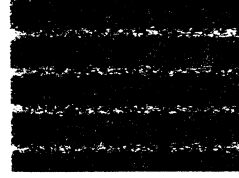

Custom Cloth bench seat for Silverado trim ▼

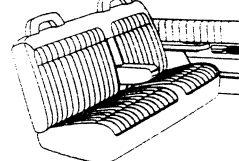

Custom Cloth 40/60 split-bench seat for Silverado trim ▼

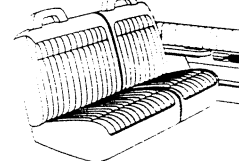

Custom Cloth reclining high-back bucket seats for Silverado trim ▼

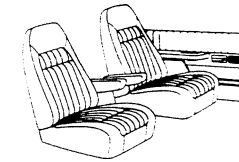

Standard 15" or 16" wheel, with Black hubcap, for W/T1500 and Cheyenne ▼

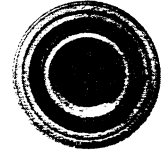

Optional 15" full wheel covers for Cheyenne ▼



Standard 15" or 16" Rally Wheel trim for ZWB Silverado, optional on Cheyenne (RPO P96) ▼



Standard chrome wheel with Black hubcap for 454SS models\* ▼



Optional 15" cast-aluminum wheel for G1500 ZWB models (incl. with ZWB Sport Pickup) (RPO N90) ▼



Optional 16" cast-aluminum wheel for K1500 models; (incl. with 4WD Sport Pickup) (RPO PF4) ▼



Standard 16" front wheel for Big Dealey ▼

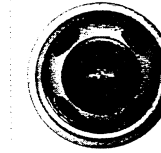

\*Also included with Z08 Sport Handling Package.

- ▶ 40/60 split-bench in cloth or vinyl, and low-back bucket seats in cloth or vinyl available with Cheyenne decor (formerly required Scottsdale trim).
- ▶ Seat-back recliner feature added to passenger side on 40/60 split-bench seat and low-back bucket seats.
- ▶ Dual cup holders mounted on instrument panel (not available with bucket seats).
- ▶ Steel sleeve steering column (with Comfortilt only) is designed for improved security. Improvements include three steel shields,

- revised lock cylinder and new lock bolt spring.
- ▶ Cloth-covered sun visors.
- ▶ Revised radio controls: new control panel and improved button operation.
- ▶ Full-cloth headliner optional for Regular-Cab C/K Pickups. (Cloth headliner continues as standard with Silverado decor on Pickup and on Extended-Cab models.)
- ▶ Electronic fuel shut-off; automatically limits maximum vehicle speed to less than tire speed rating.

- ▶ Deluxe front appearance option (RPO V22) available as an option with Cheyenne models (except W/T1500 and C3500 HD).
- ▶ Four new '93 exterior colors for Pickups and Extended-Cabs: Light Quasar Blue Metallic – Code 20, Teal Green Metallic – Code 38, Indigo Blue Metallic – Code 39 and Dark Garnet Red Metallic – Code 84. (Colors replaced are Brilliant Blue Metallic – Code 22, Smoke Blue Metallic – Code 27,

- Catalina Blue Metallic – Code 30 and Crimson Red Metallic – Code 94.)
- ▶ Scottsdale decor (RPO Z62) is cancelled for 1993.
- ▶ Special Two-Tone paint (RPO ZY3) cancelled (interim 1992 change).

# '93

## C/K Pickup and Crew-Cab

### Ordering Information

- ▶ New Sportside Sport Pickup (1500 Series Regular-Cab 2WD or 4x4 only, interim 1993 availability). Includes: Silverado trim, "Sport decals," body-color Dura-grille™ (W/T1500 type), Sportside box and cast-aluminum wheels. Painted exterior mirrors and front and rear bumpers are color-keyed to exterior color. Available in Summit White, Onyx Black or Victory Red.
  - ▶ "Leading edge" anti-chip coating (same as coating applied to rocker panels) is now used on leading edges of hood, roof and entire "A" pillars; helps prevent stone chips in these areas.
  - ▶ RPO MX0 4-speed automatic transmission now has electronic controls.
  - ▶ Solar-Ray™ tinted glass standard — all windows; reflects and absorbs up to 60 percent of the sun's energy to reduce interior heat buildup.
  - ▶ Scotchgard™ Fabric Protector on seats and door trim panels (cloth only).
  - ▶ Extended-Cab now available with 2-passenger seating (giving buyer choice of 2-, 3-, 5- or 6-passenger seating).
- (Continued on next page.)

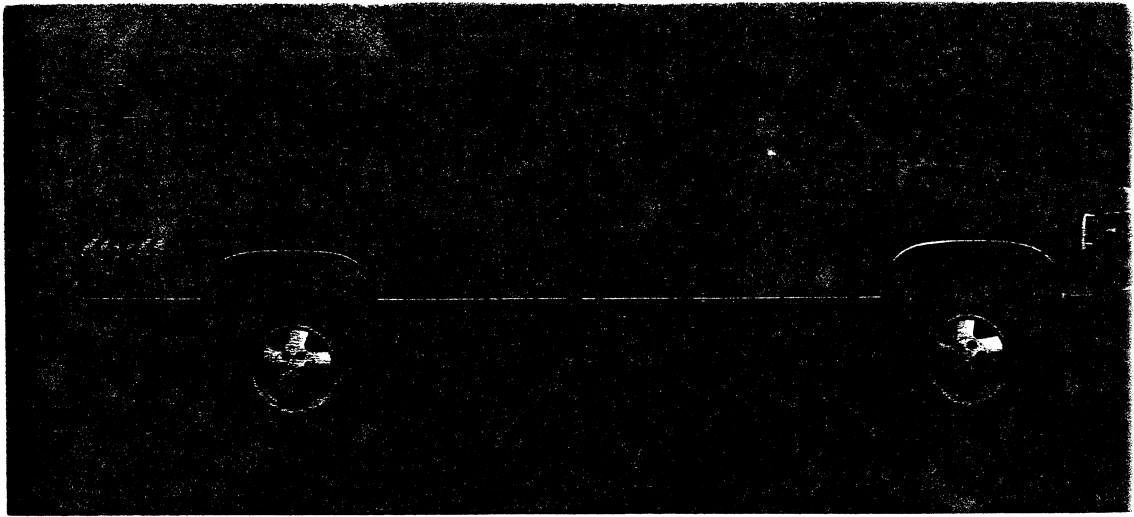

Feature Vehicle: K1500 Fleetside Long-Box Silverado ▲

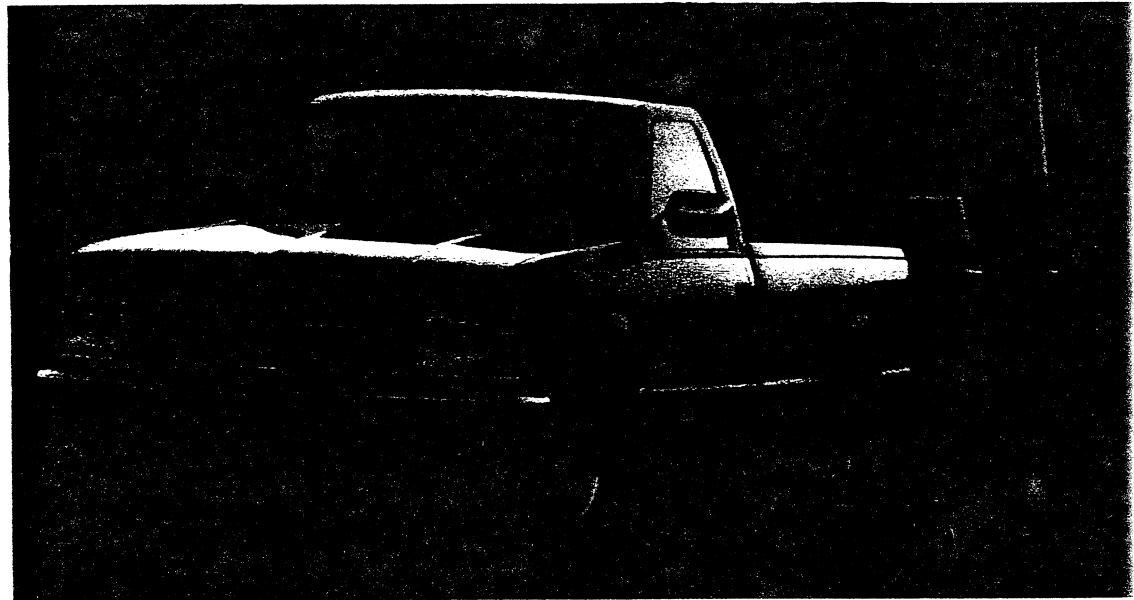

Focus Vehicle: C1500 Fleetside Long-Box Silverado ▲

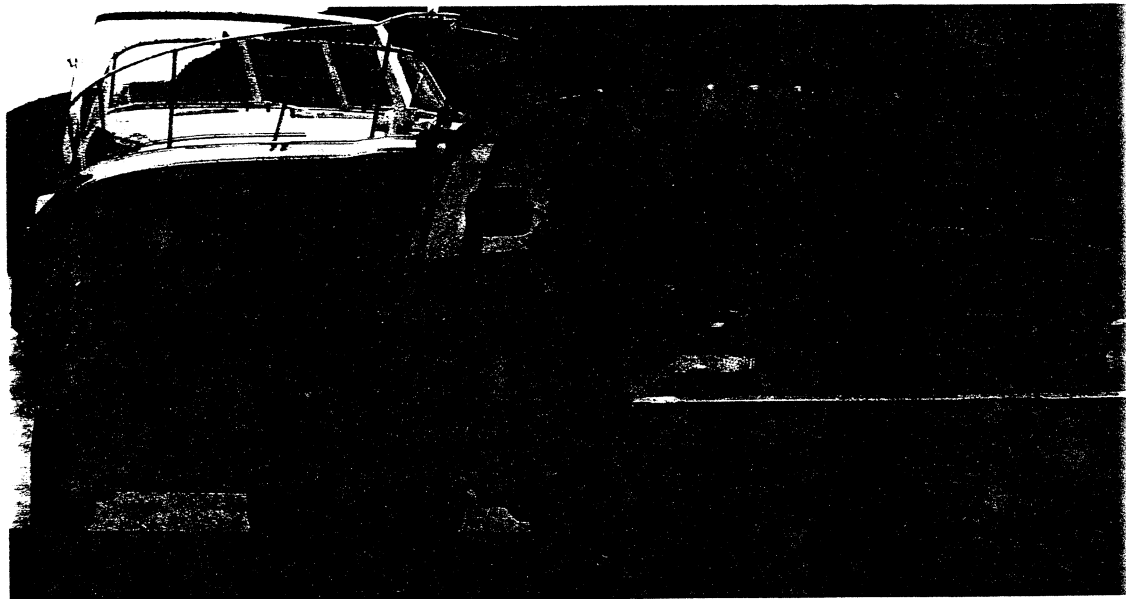

C3500 Crew-Cab Cheyenne ▲



# C/K CHASSIS-CAB

## SPECIAL EQUIPMENT OPTIONS (CONT.)

|   | LEAD TIME (DAYS) | OPTION CODE                           |
|---|------------------|---------------------------------------|
| <b>Seat Restraint, Front</b> (Dual mode retractor. N/A bucket seats or Silverado Trim)  | 56               | 9L8                                   |
| <b>Spring, Front Suspension</b> (provides higher production rated spring for Hy-Rail railroad operation. N/A C3500 HD)                            | 56               | 8W9                                   |
| <b>Spring, Rear Auxiliary</b> (for vehicle trim adjustment C20903-31003-31403 only)   | 0                | 5J9                                   |
| <b>Steering Column, Tilt</b>  | -2               | 9J6                                   |
| <b>Switch, Dome Lamp</b> (RH door operated)   | 56               | 8M3                                   |
| <b>Throttle, Hand</b> (adjustable pull type)  | 56               | 7L4                                   |
| <b>7.50-16LT/D Highway Nylon Blackwall.</b><br>(maximum tire capacity each: front 4880-lbs./rear 8560-lbs. 30903 - 30953 w/dual rear wheels only) | -2               | Front: 2DE<br>Rear: 3DL<br>Spare: 4DL |
| <b>LT245/75R16E Steel-Belted Radial Blackwall All-Season (requires YGK, NA R05)</b>   | -2               | Spare: 4HH                            |
| <b>LT225/75R16D Steel-Belted Radial Blackwall All-Season (requires YHR)</b>   | -2               | 4HP                                   |
| <b>225/70R19.5F Steel-Belted Radial BW On-Off Road (requires XTM)</b>   | -2               | 3TJ                                   |

## DIMENSIONS

| MODEL                               | C/K 2500 CHASSIS-CAB REG/EXT. |             | C/K 3500 CHASSIS-CAB REG/EXT. |             | C/K 3500 STRAIGHT FRAME CHASSIS-CAB |                   | C 3500 HD CHASSIS-CAB |             |             | CREW CAB CHASSIS-CAB |            |            |      |
|-------------------------------------|-------------------------------|-------------|-------------------------------|-------------|-------------------------------------|-------------------|-----------------------|-------------|-------------|----------------------|------------|------------|------|
| MODEL NUMBER                        | CC20903/ZW9                   | CC20953/ZW9 | CC30903/ZW9                   | CC30953/ZW9 | CC/K31003/ZW9                       | CC/K31403/ZW9/C5B | CC/31003/ZW9/C5B      | CC31403/ZW9 | CC31803/ZW9 | CC/K30943            |            |            |      |
|                                     |                               |             | R05                           | R05         |                                     |                   |                       |             |             |                      | R05        |            |      |
| <b>EXTERIOR DIMENSIONS</b>          |                               |             |                               |             |                                     |                   |                       |             |             |                      |            |            |      |
| Wheelbase (in.)                     | 31.5                          | 155.5       | 131.5                         | 131.5       | 155.5                               | 155.5             | 135.5                 | 159.5       | 135.5       | 159.5                | 183.5      | 168.5      |      |
| Overall Length (in.)                | 208.2                         | 232.12      | 208.16                        | 208.16      | 232.18                              | 232.18            | 221.47                | 245.48      | 224.1       | 248.1                | 272.1      | 250.4      |      |
| Overall Height (in.)                |                               |             |                               |             |                                     |                   |                       |             |             |                      |            |            |      |
| 2WD                                 | 75.5                          | 75.5        | 75.5                          | 75.8        | 76.0                                | 76.0              | 73.0                  | 72.7        | 75.7        | 75.7                 | 75.7       | 71.7       | 70.8 |
| 4WD                                 | 75.8                          | 75.8        | 75.8                          | 76.3        | 76.3                                | 76.3              | 73.3                  | 73.0        | —           | —                    | —          | 71.7       | 70.8 |
| Maximum Width (in.)                 | 76.4                          | 76.4        | 76.4                          | 92.2        | 76.4                                | 92.2              | 84.1                  | 84.1        | 85.7        | 85.7                 | 85.7       | 76.8       | 94.2 |
| Bumper to Axle Frt (in.)            | 34.9                          | 34.9        | 34.9                          | 34.9        | 34.9                                | 34.9              | 34.9                  | 34.9        | 37.96       | 37.96                | 37.96      | 34.9       |      |
| Rear Axle to End of Frame (in.)     | 41.7                          | 41.7        | 41.7                          | 41.7        | 41.7                                | 41.7              | 51.02                 | 51.02       | 51.02       | 51.02                | 51.02      | 46.5       |      |
| Cab Axle (in.)                      | 55.9                          | 55.9        | 55.9                          | 55.9        | 55.9                                | 55.9              | 60.0                  | 84.0        | 60.0        | 84.0                 | 108.0      | 55.9       |      |
| Cab to End of Frame (in.)           | 97.6                          | 97.6        | 97.6                          | 97.6        | 97.6                                | 97.6              | 110.94                | 134.96      | 111.0       | 135.0                | 159.0      | 97.0       |      |
| Bumper to Back of Cab (in.)         | 110.6                         | 134.6       | 110.6                         | 110.6       | 134.6                               | 134.6             | 110.6                 | 110.6       | 113.1       | 113.1                | 113.1      | 152.0      |      |
| Ground to Top of Frame (in.)        |                               |             |                               |             |                                     |                   |                       |             |             |                      |            |            |      |
| 2WD                                 | 31.43                         | 31.43       | 31.43                         | 31.69       | 31.69                               | 31.69             | 31.89                 | 31.89       | 30.3        | 30.3                 | 30.3       | 29.9       | 29.2 |
| 4WD                                 | 31.79                         | 31.79       | 31.79                         | 31.82       | 31.82                               | 31.82             | 31.89                 | 31.89       | —           | —                    | —          | 29.9       | 29.2 |
| Ground Clearance Front (in.)        |                               |             |                               |             |                                     |                   |                       |             |             |                      |            |            |      |
| 2WD/4WD                             | 8.4/8.7                       | 8.4/9.2     | 8.4/8.7                       | 7.9/7.8     | 7.8/7.7                             | 7.7/7.7           | 7.8/7.6               | 7.8/7.6     | 10.8        | 10.8                 | 10.8       | 8.0/8.0    |      |
| Rear (in.)                          |                               |             |                               |             |                                     |                   |                       |             |             |                      |            |            |      |
| 2WD/4WD                             | 8.1/7.7                       | 8.1/8.2     | 8.1/7.7                       | 7.6/8.1     | 7.5/8.1                             | 7.5/8.1           | 7.6/7.4               | 7.6/7.4     | 8.0         | 8.0                  | 8.0        | 7.7/7.7    |      |
| Frame Width                         | 45.3                          | 45.3        | 45.3                          | 45.3        | 45.3                                | 45.3              | 34.0                  | 34.0        | 34.0        | 34.0                 | 34.0       | 45.3       |      |
| Turning Diameter Curb-to-Curb (ft.) |                               |             |                               |             |                                     |                   |                       |             |             |                      |            |            |      |
| 2WD                                 | 45.7                          | 52.9        | 45.7                          | 45.7        | 52.9                                | 52.9              | 46.7                  | 52.9        | 45.97       | 52.94                | 59.8       | 56.7       | 56.8 |
| 4WD                                 | 45.1                          | 52.2        | 45.1                          | 45.1        | 52.2                                | 52.2              | 47.6                  | 54.8        | —           | —                    | —          | 57.6       | 57.6 |
| <b>SIGN PANEL AREA (in.)</b>        | 17 X 48.75                    | 17 X 77.50  | 17 X 48.75                    | 17 X 48.75  | 17 X 77.50                          | 17 X 77.50        | 17 X 48.75            | 17 X 48.75  | 17 X 48.75  | 17 X 48.75           | 17 X 48.75 | 17 X 85.75 |      |

**DIMENSIONS (CONT.)**

| MODEL                         | C/K 2500<br>CHASSIS-CAB<br>REG/EXT. |                 | C/K 3500<br>CHASSIS-CAB<br>REG/EXT. |      |                 |           | C/K 3500<br>STRAIGHT FRAME<br>CHASSIS-CAB |                      | C 3500 HD<br>CHASSIS-CAB |                |                | CREW CAB<br>CHASSIS-CAB |
|-------------------------------|-------------------------------------|-----------------|-------------------------------------|------|-----------------|-----------|---|----------------------|--------------------------|----------------|----------------|-------------------------|
| MODEL<br>NUMBER               | CC20903/<br>ZW9                     | CC20953/<br>ZW9 | CC30903/<br>ZW9                     |      | CC30953/<br>ZW9 |           | CC/K31003<br>/ZW9                         | CC/K31403<br>ZW9/C5B | CC/31003<br>ZW9/C5B      | CC31403<br>ZW9 | CC31803<br>ZW9 | CC/K30943               |
|                               |                                     |                 | R05                                 |      | R05             |           |   |                      |                          |                |                | R05                     |
| <b>INTERIOR DIMENSIONS</b>    |                                     |                 |                                     |      |                 |           |   |                      |                          |                |                |                         |
| <b>CAB</b>                    |                                     |                 |                                     |      |                 |           |   |                      |                          |                |                |                         |
| Headroom<br>F/R (in.)         | 40.0                                | 40.0/37.5       | 40.0                                | 40.0 | 40.0/37.5       | 40.0/37.5 | 40.0                                      | 40.0                 | 40.0                     | 40.0           | 40.0           | 41.1/39.9               |
| Legroom<br>F/R (in.)          | 41.7                                | 41.7/32.1       | 41.7                                | 41.7 | 41.7/32.1       | 41.7/32.1 | 41.7                                      | 41.7                 | 41.8                     | 41.8           | 41.8           | 40.8/32.4               |
| Shoulder<br>Room<br>F/R (in.) | 66.0                                | 66.0/67.6       | 66.0                                | 66.0 | 66.0/67.6       | 66.0/67.6 | 66.0                                      | 66.0                 | 66.0                     | 66.0           | 66.0           | 65.4/65.4               |
| Hip Room<br>F/R (in.)         | 60.7                                | 60.7/60.7       | 60.7                                | 60.7 | 60.7/60.7       | 60.7/60.7 | 60.7                                      | 60.7                 | 60.5                     | 60.5           | 60.5           | 60.0/60.8               |

# C/K CHASSIS-CAB

## INTERIOR EQUIPMENT (CONT.)

| KEY: ■ = STANDARD, — = NOT INCLUDED |   | CHEYENNE<br>(STANDARD) | SILVERADO<br>(YE9)<br>(N/A W/3500 HD) |
|-------------------------------------|---|------------------------|---------------------------------------|
| <b>SEATS</b>                        | Scotchgard™ protection on cloth seats and cloth door panels.<br>Regular Cab: Front 3-passenger split bench with head restraints and folding backrests.<br>Extended Cab: Front 3-passenger 40/60 split bench with head restraints, easy entry feature and a folding rear seat.<br>Extended Cab: Custom front 3-passenger 40/60 split bench with head restraints and folding backrest and rear 3-passenger bench with folding backrest.<br>Crew Cab: Front 3-passenger bench with head restraints and folding backrest, and rear 3-passenger bench with folding backrest. | ■<br>■<br>■<br>—<br>■  | ■<br>■<br>—<br>■<br>■                 |
| <b>STEERING WHEEL</b>               | Custom urethane 4-spoke.<br>Sport urethane 4-spoke.   | ■<br>—                 | —<br>■                                |
| <b>STOWAGE TRAY</b>                 | Full width behind seat on floor.  | —                      | ■                                     |
| <b>SUNSHADES</b>                    | Color-keyed cloth RH and LH padded.<br>Color-keyed RH and LH padded with cloth covering, storage strap on LH unit and visor mirror on RH unit.<br>Crew Cab: Padded, color-keyed RH and LH sunshades with extenders and illuminated mirrors. LH sunshade has storage strap.  | ■<br>—<br>—            | —<br>■<br>■                           |
| <b>TOOLS</b>                        | Mechanical jack and wheel wrench located behind front seat or on rear compartment floor.  | ■                      | ■                                     |
| <b>TRIM PANELS</b>                  | Extended Cabs have rear, upper, lower and side trim panels and a molded color-keyed cloth headliner with matching retaining moldings.   | ■                      | ■                                     |
| <b>WINDOWS</b>                      | Solar-Ray tinted glass.   | ■                      | ■                                     |
| <b>WINDSHIELD WIPERS</b>            | Intermittent.   | ■                      | ■                                     |

## PREFERRED EQUIPMENT GROUPS

Preferred Equipment Groups (PEGs) are convenient option packages that can save your customers money. They would pay appreciably more by buying all the options in a Preferred Equipment Group as individual options. (Savings based on a comparison of MSRP of option packages versus MSRP of individual options purchased separately.) See your 1993 Chevrolet Truck Order Guide and Vehicle Price Schedule for specific information and prices.

## OPTIONS

These options can be ordered individually in addition to the Preferred Equipment Groups if not already included. See your 1993 Chevrolet Truck Order Guide for specific availability and restrictions. The Option Code is listed in **bold type**.

Air Conditioning ..... **C60**  
 Appearance Package (includes chrome grille, composite halogen headlamps and dual horns: N/A C3500HD) ..... **V22**  
 Axles, Rear (see Order Guide for GQ1):  
   3.42 ..... **GU6**  
   3.73 ..... **GT4**  
   4.10 ..... **GT5**  
   4.56 ..... **HC4**  
   4.63 ..... **GK9**  
   5.13 ..... **HC7**  
 Axle, Rear Locking Differential ..... **G80**  
 Axle, Rear Wide Track, 92.2-in. wide (C/K 31003.31403 only) ..... **GTY**  
 Battery, Heavy-Duty Auxiliary (540 CCA) ..... **TP2**  
 Bumper Guards, Front Black ..... **V27**  
 Chassis, Heavy-Duty ..... **F44**  
 Cold Climate Package (includes engine block heater, anti-freeze protection to -32°F and special insulation) ..... **V10**  
 Cooling System:  
   Heavy-Duty Radiator ..... **V01**  
   Heavy-Duty Radiator and Transmission Oil Cooler ..... **V02**  
 Convenience Package, Driver's (includes ComfortTilt™ steering and electronic speed control) ..... **ZQ3**  
 Convenience Package, Operating (includes power door locks and power windows) ..... **ZQ2**

Defogger, Rear Window (Extended Cab and Crew Cab only) ..... **C49**  
 Emissions:  
   Standard ..... **NA5**  
   High Altitude ..... **NA6**  
   California ..... **YF5**  
 Engines (see Powertrains)  
   Alternative Fuel (LPG or CNG Conversion Ready) ..... **KL5**  
 Floor Covering, Full-Floor, Rubber, Color-Keyed ..... **BG9**  
 Glass, Deep Tinted, sides and rear (Extended Cab and Crew Cab only, includes swing-out windows A20) ..... **AJ1**  
 GVWR (non-merchandise codes for information only):  
   8600 lbs. .... **C6P**  
   9000 lbs. .... **C6U**  
   9200 lbs. .... **C6W**  
   10,000 lbs. .... **C7A**  
   11,000 lbs. .... **C7E**  
   12,000 lbs. .... **C7L**  
   15,000 lbs. .... **C5B**  
 Interior Package (includes headliner and retainer moldings) ..... **BB5**  
 Lamps, Cargo Area ..... **UF2**  
 Lamps, Dome and Reading (included w/auxiliary lighting TR9) ..... **C95**  
 Lamps, Roof Marker (included w/cuati rear wheels R05) ..... **U01**  
 License Plate Bracket, Front ..... **VK3**

Lighting, Auxiliary (dome, reading, ashtray, glove box and underhood lamps) ..... **TR9**  
 Mirrors, Exterior Below-Eye-Line Type (LH and RH stainless steel, Mirror head: 9.0" x 6.5") ..... **D45**  
 Mirrors, Exterior Camper Type (LH and RH stainless steel, Mirror head: 7.5" x 10.5") ..... **DF2**  
 Mirrors, Exterior West Coast Type (LH and RH stainless steel, Mirror head: 7.0" x 16.0") ..... **DG5**  
 Paint, Exterior: Solid ..... **ZY1**  
 Radio Equipment:  
   Radio Delete ..... **UL5**  
   ETR AM/FM Stereo Radio w/ Seek-Scan, Stereo Cassette and Digital Clock ..... **UM6**  
   ETR AM/FM Stereo Radio w/ Seek-Scan and Digital Clock ..... **UM7**  
   ETR AM/FM Stereo Radio w/ Seek-Scan, Digital Cassette w/ Search Repeat, Graphic Equalizer and Digital Clock ..... **UX1**  
 Seat, Power Driver's Adjuster (Crew Cab only) ..... **AG9**  
 Skid Plate (4WD models only) ..... **NZZ**  
 Snow Plow Prep Package (4WD Reg. Cab only) ..... **VYU**  
 Springs (torsion bars), Front Heavy-Duty (4x4 only) ..... **F60**  
 Stabilizer Shaft, Rear (C/K 31003.31403 only) ..... **F61**

**OPTIONS (CONT.)**

Tachometer, Engine (mounted in instrument cluster) ..... **U16**  
 Tank, Fuel (rear-mounted 31-gal. approx.)(C/K 31003-31403 and C31803 only) ..... **NK7**  
 Tow Hooks, Front (4 x 2 only) ..... **V76**  
 Transmissions:  
 5-Speed Manual with Deep Low

Overdrive, HD ..... **MT8**  
 Electronically-Controlled 4-Speed Automatic.  
 Overdrive, HD ..... **MX0 (MT1)**  
 Wheel Covers (Requires R04) ..... **P01**  
 Wheel Rally Trim (Requires R05) ..... **P06**  
 Wheels, Dual Rear

C/K3500 only) ..... **R05**  
 Wheels, Single Rear ..... **R04**  
 Windows, Sliding Rear ..... **A28**  
 Windows, Swing-Out Quarter (Extended Cab only) ..... **A20**

| <b>TIRES</b>  |                  |       |      |       |  |
|---|------------------|-------|------|-------|--|
| <b>KEY: AS = ALL-SEASON SBR = STEEL-BELTED RADIAL PLY BW = BLACKWALL WW = WHITEWALL WL = WHITE LETTERED HWY = HIGHWAY BL = BLACK LETTERED ON-OFF = ON-OFF ROAD WOL = WHITE OUTLINE LETTERED</b> |                  |       |      |       |  |
| (N/A C3500 HD)  |                  | FRONT | REAR | SPARE |  |
| LT225/75R16C  | AS/SBR/BL        | XHE   | YHE  | ZHE   |  |
| LT225/75R16D  | AS/SBR/BW        | XHP   | YHP  | ZHP   |  |
| LT225/75R16D  | ON-OFF/AS/SBR/BW | XHR   | YHR  | ZHR   |  |
| LT245/75R16E  | AS/SBR/BW        | XHH   | YHH  | ZHH   |  |
| LT245/75R16E  | ON-OFF/SBR/BW    | XGK   | YGK  | ZGK   |  |
| 7.50-16D  | HWY/NYLON/BW     | XDE   | YDE  | ZDE   |  |
| 7.50-16D  | ON-OFF/NYLON/BW  | XDL   | YDL  | ZDL   |  |

**SPECIAL EQUIPMENT OPTIONS**

The following special equipment is installed at the assembly plant. See your 1993 SEO catalog for details.

| <b>SPECIAL EQUIPMENT OPTIONS</b>  |  |  | LEAD TIME (DAYS) | OPTION CODE |
|---|--|--|------------------|-------------|
| <b>Anti-freeze, Permanent</b> (ethylene glycol protection to -34°F)   |  |  | 0                | <b>8B3</b>  |
| <b>Axle, Rear Full Floating</b> (C/K20903-20953 only. N/A with SEO 5J9 Auxiliary Spring)  |  |  | 49               | <b>1TA</b>  |
| <b>Bumper, Front Painted Black</b>  |  |  | 42               | <b>8E8</b>  |
| <b>Bumper, Front Delete</b>   |  |  | (will advise)    | <b>8H5</b>  |
| <b>Carrier and Wheel</b> . Spare does not include spare tire (C/K2500 and 3500 only, located under frame at rear)   |  |  | 56               | <b>5V1</b>  |
| <b>Chassis-Special</b> . Single Rear Wheels (C/K 31003-C31403 only)   |  |  | 56               | <b>8S9</b>  |
| <b>Cold Climate Package</b> (diesel models only. C/K2500 and 3500 only. N/A C/K20753. Provides use of Arctic grade fuel)  |  |  | 56               | <b>8N1</b>  |
| <b>Cruise Control, Automatic</b>  |  |  | 42               | <b>5K3</b>  |
| <b>Generator: Delco 105-Amp</b>   |  |  | 42               | <b>8W5</b>  |
| <b>Generator: Delco 124-Amp</b>   |  |  | 42               | <b>8A3</b>  |
| <b>Headlamps-On Warning</b> (included w/auxiliary lighting TR9)   |  |  | 56               | <b>9W7</b>  |
| <b>Horn, High Note</b> (included w/C3500 HD)  |  |  | 0                | <b>7Z1</b>  |
| <b>Jack</b> (C/K31003 and 31043 only).  |  |  | 42               | <b>8V2</b>  |
| <b>Key Equipment</b> (C/K31003- 31403 only, single key system)  |  |  | 42               | <b>6A4</b>  |
| <b>Lamp, Roof Marker Delete</b> (C/K31003-31403 only, N/A C3500 HD)   |  |  | 0                | <b>9H5</b>  |
| <b>Meter, Engine Hour</b>   |  |  | 56               | <b>7Y4</b>  |
| <b>Mirror, Delete, Inside</b> (C/K31003-31403 only)   |  |  | 0                | <b>9D9</b>  |
| <b>Mirror, Delete, Outside Rearview</b> (LH and RH, N/A CK20753)  |  |  | 0                | <b>9F2</b>  |
| <b>Mirror Outside Rearview</b> (Velvac 6.5" x 6.0" plain and 6.5" x 6.0" convex, each side. Inside dimension of 77")  |  |  | 0                | <b>6M1</b>  |
| <b>Black</b>  |  |  | 56               | <b>6L8</b>  |
| <b>Mirror Outside Rearview</b> (Velvac 6.5" x 10.0" plain and 6.5" x 6.0" convex, each side. Inside dimension of 77")   |  |  | 0                | <b>6P3</b>  |
| <b>Black</b>  |  |  | 56               | <b>6N9</b>  |
| <b>Mirror Outside Rearview</b> (Velvac Wideloop 6.5" x 10.0" plain and 6.5" x 6.0" convex, each side. Inside dimension of 96")<br>N/A above 10000-lb. GVW                         |  |  | 0                | <b>8B2</b>  |
| <b>White</b>  |  |  | 56               | <b>8G9</b>  |
| <b>Stainless Steel</b>  |  |  |                  |             |
| <b>Mirror Outside Rearview</b> (Velvac 6.5" x 6.0" convex dual spot-stainless steel. Available only w/West Coast mirrors)   |  |  | 42               | <b>9J7</b>  |
| <b>Mirror Outside Rearview</b> (Velvac West Coast type. Stainless steel. Shipped loose.)  |  |  | 56               | <b>9F8</b>  |
| <b>Paints: Solid.</b>   |  |  |                  |             |
| <b>Orange, Tangier</b> WE9417   |  |  | 42               | <b>9W4</b>  |
| <b>Yellow, Wheatland</b> WE9418   |  |  | 42               | <b>9W3</b>  |
| <b>Green, Woodland</b> WE9015   |  |  | 42               | <b>9V5</b>  |
| <b>Tan, Doeskin</b> WE9403  |  |  | 42               | <b>9V9</b>  |
| <b>Seats, Bucket</b> (Driver and passenger without front center console.<br>N/A Extended Cab w/rear seat. N/A Gray trim. N/A C3500 HD)  |  |  | 42               | <b>8W7</b>  |
| <b>Seat, Front Deletion</b> (retains LH and RH bucket type seat belts only. Rear seat remains in Extended Cab except when solid front bench seat trim is specified. N/A C3500 HD) |  |  | 56               | <b>8E2</b>  |
| <b>Seat, Rear Non-installed</b> (Extended Cab only)   |  |  | 0                | <b>8Q3</b>  |

# C/K CHASSIS-CAB

| REAR AXLES               |                       |      |      |      |                                |      |      |                                |      |      |                                  |      |      |                         |      |
|--------------------------|-----------------------|------|------|------|--------------------------------|------|------|--------------------------------|------|------|----------------------------------|------|------|-------------------------|------|
| Make                     | GM                    |      |      |      | GM                             |      |      | GM                             |      |      | GM                               |      |      | DANA                    |      |
| Capacity (lbs.)          | 6000<br>Semi-Floating |      |      |      | 6084<br>Full-Floating          |      |      | 7500<br>Full Floating          |      |      | C: 8250/K: 8600<br>Full-Floating |      |      | 11,000<br>Full-Floating |      |
| Availability             | C/K2500               |      |      |      | C/K30903-30953-<br>30943 W/R04 |      |      | C/K30903-30953-<br>30943 W/R05 |      |      | C/K31003-31403                   |      |      | C3500 HD                |      |
| Pinion & Ring Gear Type  | Hypoid                |      |      |      | Hypoid                         |      |      | Hypoid                         |      |      | Hypoid                           |      |      | Hypoid                  |      |
| Axle Ratio Code          | GU6                   | GT4  | GT5  | HC4  | GT4                            | GT5  | HC4  | GT4                            | GT5  | HC4  | GT4                              | GT5  | HC4  | GK9                     | HC7  |
| Ratio                    | 3.42                  | 3.73 | 4.10 | 4.56 | 3.73                           | 4.10 | 4.56 | 3.73                           | 4.10 | 4.56 | 3.73                             | 4.10 | 4.56 | 4.63                    | 5.13 |
| Pinion Teeth             | 12                    | 11   | 10   | 9    | 11                             | 10   | 9    | 11                             | 10   | 9    | 11                               | 10   | 9    | 8                       | 7    |
| Ring Gear Teeth          | 41                    | 41   | 41   | 41   | 41                             | 41   | 41   | 41                             | 41   | 41   | 41                               | 41   | 41   | 37                      | 37   |
| Ring Gear Diameter (in.) | 9.5                   | 9.5  | 9.5  | 9.5  | 10.5                           | 10.5 | 10.5 | 10.5                           | 10.5 | 10.5 | 10.5                             | 10.5 | 10.5 | 11.5                    | 11.5 |

Note: Axle Ratio depends on model, powertrain and emissions selected. See your 1993 Chevrolet Truck Order Guide.

| FRONT AXLE K MODELS              |                            |      |      |      |                            |      |      |  |
|----------------------------------|----------------------------|------|------|------|----------------------------|------|------|--|
| Make                             | GM                         |      |      |      | GM                         |      |      |  |
| Capacity (lbs.)                  | 4250                       |      |      |      | 4500                       |      |      |  |
| Availability                     | K2500, K30903-30953        |      |      |      | K31003-31403-30943         |      |      |  |
| Pinion and Ring Gear Type        | Hypoid                     |      |      |      | Hypoid                     |      |      |  |
| Ratio                            | 3.42                       | 3.73 | 4.10 | 4.56 | 3.73                       | 4.10 | 4.56 |  |
| Pinion Teeth                     | 12                         | 11   | 10   | 9    | 11                         | 10   | 9    |  |
| Ring Gear Teeth                  | 41                         | 41   | 41   | 41   | 41                         | 41   | 41   |  |
| Ring Gear Diameter (in.)         | 8.25                       | 8.25 | 8.25 | 8.25 | 9.25                       | 9.25 | 9.25 |  |
| Differential Type Bearings, Type | 2-Pinion<br>Tapered Roller |      |      |      | 2-Pinion<br>Tapered Roller |      |      |  |
| Lubricant Capacity (quints)      | 4.5                        |      |      |      | 6                          |      |      |  |

Note: Axle Ratio depends on model, powertrain and emissions selected. See your 1993 Chevrolet Truck Order Guide.

## TRIM LEVELS

Chevrolet offers the C/K 2500 and 3500 Chassis-Cab in two trim levels, "Cheyenne" and "Silverado." The C3500 HD Chassis-Cab is available in one trim level, "Cheyenne." The following chart details major standard features. See your 1993 Chevrolet Truck Order Guide for more details.

| CHASSIS EQUIPMENT                          |   | CHEYENNE<br>(STANDARD) | SILVERADO<br>(YE9)<br>(N/A W/3500 HD) |
|--|---|------------------------|---------------------------------------|
| <b>KEY: ■ = STANDARD, — = NOT INCLUDED</b> |   |                        |                                       |
| <b>BRAKES</b>                              | Power-assisted; front disc, rear drum (rear disc on C3500 HD). Includes rear-wheel anti-lock system that operates in 2-wheel drive only.  | ■                      | ■                                     |
| <b>EXHAUST</b>                             | Single.   | ■                      | ■                                     |
| <b>FRAME</b>                               | All-welded ladder-type, channel design and boxed front-end section.<br>C/K20903 - 30903: 2WD-5.38 cu. in.; 4WD-5.61 cu. in.<br>C/K31003 - 31403: 2WD-6.47 cu. in.; 4WD-6.76 cu. in.<br>C/K20953 - 30953: 2WD-6.21 cu. in.; 4WD-6.48 cu. in.<br>3500HD: 31003, 31403-8.78 cu. in.; 31803-9.75 cu. in. Crew Cab: 7.49 cu. in. | ■                      | ■                                     |
| <b>FUEL TANK</b>                           | 34.0 (approx.) gallons on C/K 20903/53 and C/K30903/53.<br>22.0/31.0 (approx.) gallons on C/K 31003, 31403 and 3500 HD.   | ■                      | ■                                     |
| <b>REAR AXLE</b>                           | Hypoid, semi-floating on C/K 2500. Full-floating on C/K2500 with L19 or L65 and C/K3500.  | ■                      | ■                                     |
| <b>SHOCK ABSORBERS</b>                     | Front: 35mm/Rear: 32mm (35mm on C3500 HD).  | ■                      | ■                                     |
| <b>STABILIZER BAR</b>                      | 4x2: Front 1.25 inch. 4x4: Front 1.18-inch.   | ■                      | ■                                     |
| <b>STEERING</b>                            | Integral Power.   | ■                      | ■                                     |
| <b>SUSPENSION, FRONT</b>                   | 4x2: Independent with computer-selected coil springs (I-beam/leaf springs on C3500 HD).<br>4x4: Independent with computer-selected torsion bars.  | ■                      | ■                                     |
| <b>SUSPENSION, REAR</b>                    | C/K2500: Semi-elliptic two-stage multi-leaf springs C/K3500: Semi-elliptic two-stage multi-leaf springs main/auxiliary. (No auxiliary on C3500 HD).   | ■                      | ■                                     |
| <b>TOW HOOKS</b>                           | Two front on 4x4s.  | ■                      | ■                                     |

| EXTERIOR EQUIPMENT                         |  | CHEYENNE<br>(STANDARD) | SILVERADO<br>(YE9)<br>(N/A W/3500 HD) |
|--|--|------------------------|---------------------------------------|
| <b>KEY:</b> ■ = STANDARD, — = NOT INCLUDED |  |                        |                                       |
| <b>FRONT BUMPER</b>                        | Chromed (w/black rub strip on Crew Cab).<br>Chromed w/black rub strip and bright trim.   | ■<br>—                 | —<br>■                                |
| <b>GRILLE</b>                              | Molded plastic painted light argent with dark argent air intake areas.<br>Deluxe dark argent grille w/bright trim (except C3500 HD).   | ■<br>—                 | —<br>■                                |
| <b>HEADLAMPS</b>                           | Single rectangular halogen.<br>Composite halogen (except C3500 HD).  | ■<br>—                 | —<br>■                                |
| <b>HORN</b>                                | Single electric low-note.<br>Dual low- and high-note (standard C3500 HD).  | ■<br>—                 | —<br>■                                |
| <b>INSULATION</b>                          | Hood and cab-to-fender.  | —                      | ■                                     |
| <b>LIGHTS</b>                              | Dual rear wheel models only, five amber roof marker lamps.   | ■                      | ■                                     |
| <b>MIRRORS</b>                             | RH and LH below-eye-line type painted black w/adjustable heads.<br>Head size 9.0" x 6.5."<br>Chrome RH and LH below-eye-line type. Head size 9.0" x 6.5."  | ■<br>—                 | —<br>■                                |
| <b>TIRES</b>                               | Four on single rear wheel models and six on dual rear wheel models.<br>C/K 2500, C/K 3500, W/R04: LT245/75R16E<br>C/K 3500 W/R05: LT225/75R16 C/D<br>3500 HD: 225/70R 19.5F<br>(See Order Guide for details)   | ■                      | ■                                     |
| <b>WHEELS</b>                              | Silver painted steel wheels with black hub ornament.<br>C/K2500, C/K3500 w/R04: 16.0" x 6.5"<br>C/K3500 w/R05: 16.0" x 6.0"<br>Crew Cab: 16.0" x 6.5"<br>Crew Cab w/R05: 16.0" x 6.0" (rear only)<br>3500 HD: 19.5" x 6.0"<br>Rally wheel trim.<br>Crew Cab: Full wheel covers, N/A R05. | ■<br><br>—<br>—        | —<br><br>■<br>■                       |
| <b>WHEEL OPENING FLARES</b>                | Front.   | ■                      | ■                                     |
| <b>WINDOWS</b>                             | Extended Cab: Swing-out quarter windows.   | —                      | ■                                     |

| INTERIOR EQUIPMENT                      |   | CHEYENNE<br>(STANDARD) | SILVERADO<br>(YE9)<br>(N/A W/3500 HD) |
|---|---|------------------------|---------------------------------------|
| <b>ARMRESTS</b>                         | RH and LH padded integral with door panels.   | ■                      | ■                                     |
| <b>CAB BACK PANELS</b>                  | Color-keyed carpet.   | —                      | ■                                     |
| <b>CIGARETTE LIGHTER</b>                | Located on instrument panel.  | ■                      | ■                                     |
| <b>CUP HOLDERS</b>                      | Under dash.   | ■                      | ■                                     |
| <b>DOME LAMP</b>                        | Switch in LH door jamb only (two lamps with front door actuated switches on Crew Cab).<br>Switches in RH and LH front door jambs. (Crew Cab includes switches in all doors.)  | ■<br>—                 | —<br>■                                |
| <b>DOOR PANELS</b>                      | Grained molded plastic.<br>Special color-keyed door trim panels with decorative inserts, map pockets, padded arm rests and carpet trim.   | ■<br>—                 | —<br>■                                |
| <b>DOOR PILLAR<br/>ROOF SIDE PANELS</b> | Color-keyed.  | —                      | ■                                     |
| <b>DOOR SILL PLATE</b>                  | Color-keyed.  | ■                      | ■                                     |
| <b>FLOOR COVERING</b>                   | Embossed black rubber mat.<br>Color-keyed carpeting and removable color-keyed floor mats.   | ■<br>—                 | —<br>■                                |
| <b>GAGES</b>                            | Including fuel level, odometer, oil pressure, speedometer, telltale lights, engine temperature and voltmeter.   | ■                      | ■                                     |
| <b>GLOVE BOX</b>                        | Latched door and beverage holder.   | ■                      | ■                                     |
| <b>HEADLINER</b>                        | Vinyl with matching retainer moldings, color-keyed<br>Cloth with matching retainer moldings, color-keyed.   | ■<br>—                 | —<br>■                                |
| <b>HEATER</b>                           | Deluxe heater and defogger with side window defogger.   | ■                      | ■                                     |
| <b>INSULATION</b>                       | Provided on dash panel, cowl top and sides, and doors. Extended Cabs have additional insulation on the rear quarter and back panels and on floor coverings. Extra insulation is provided with diesel engines.<br>Plus insulation on headliners.<br>Plus insulation on Regular Cab Panels. | ■<br>—<br>—            | ■<br>■<br>■                           |
| <b>MIRRORS</b>                          | 10-inch rearview.   | ■                      | ■                                     |
| <b>RADIO</b>                            | ETR AM radio with two 4" x 6" standard front dash speakers and fixed mast antenna.<br>ETR AM/FM stereo radio with seek-scan and digital clock. Includes two 4" x 6" front dash standard speakers and two 4" x 6" rear extended range speakers located to rear above door.                 | ■<br>—                 | —<br>■                                |

# C/K CHASSIS-CAB

| SERIES   | MODEL NUMBER/<br>BODY CODE/<br>OPTION CODE | PASSENGER CAPACITY<br>(STD./OPT.) | STANDARD ENGINE/<br>TRANS. | OPTIONAL ENGINE/<br>TRANS.                                    | GVWR<br>(LBS.) | GAWR<br>(LBS.)<br>FRONT/<br>REAR | MAXIMUM PAYLOAD<br>(LBS.)<br>BASED ON<br>CURB WT. | MAX. GROSS TRAILER WT./<br>TONGUE LOAD (LBS.)<br>PROPERLY EQUIPPED |
|--|--|-----------------------------------|----------------------------|---|----------------|----------------------------------|---|--|
| <b>TWO-WHEEL DRIVE MODELS (CONT.)</b>                                  |  |                                   |                            |   |                |                                  |   |  |
| <b>C3500 HD REGULAR CAB</b>  |  |                                   |                            |   |                |                                  |   |  |
| <b>DUAL REAR WHEELS</b>  | CC31003/<br>ZW9/C5B                        | 3/—                               | 5.7L V8/M5                 | —<br>7.4L V8/M5/A4<br>6.5L V8/M5/A4                           | 15000          | 5000/11000                       | 9659  | 10000/1000<br>10000/1000<br>10000/1000                             |
| <b>DUAL REAR WHEELS</b>  | CC31403/<br>ZW9/C5B                        | 3/—                               | 5.7L V8/M5                 | —<br>7.4L V8/M5/A4<br>6.5L V8/M5/A4                           | 15000          | 5000/11000                       | 9586  | 10000/1000<br>10000/1000<br>10000/1000                             |
| <b>DUAL REAR WHEELS</b>  | CC31803/<br>ZW9                            | 3/—                               | 5.7L V8/M5                 | —<br>7.4L V8/M5/A4<br>6.5L V8/M5/A4                           | 15000          | 5000/11000                       | 9439  | 10000/1000<br>10000/1000<br>10000/1000                             |
| <b>C3500 CREW CAB</b>  |  |                                   |                            |   |                |                                  |   |  |
| <b>SINGLE REAR WHEELS</b>  | CC30943/<br>ZW9                            | 6/5                               | 5.7L V8/M5                 | 5.7L V8/A4<br>7.4L V8/M5/A4<br>6.5L V8/M5/A4                  | 9000           | 4100/6084                        | 4038  | 10000/1000<br>10000/1000<br>9500/1000                              |
| <b>DUAL REAR WHEELS</b>  | CC30943/<br>ZW9/R05                        | 6/5                               | 5.7L V8/M5                 | 5.7L V8/A4<br>7.4L V8/M5/A4<br>6.5L V8/M5/A4                  | 10000          | 4100/7500                        | 4824  | 10000/1000<br>10000/1000<br>9500/1000                              |
| <b>FOUR-WHEEL DRIVE MODELS</b>   |  |                                   |                            |   |                |                                  |   |  |
| <b>K2500 REGULAR CAB</b>   |  |                                   |                            |   |                |                                  |   |  |
| <b>SINGLE REAR WHEELS</b>  | CK20903/<br>ZW9                            | 3/2                               | 5.7L V8/M5                 | 5.7L V8/A4<br>7.4L V8/M5/A4<br>6.2L V8/M5/A4<br>6.5L V8/M5/A4 | 8600           | 3750/6000                        | 4078  | 10000/1000<br>10000/1000<br>8500/1000<br>9500/1000                 |
| <b>K2500 EXTENDED CAB</b>  |  |                                   |                            |   |                |                                  |   |  |
| <b>SINGLE REAR WHEELS</b>  | CK20953/<br>ZW9                            | 6/5/3                             | 5.7L V8/M5                 | 5.7L V8/A4<br>7.4L V8/M5/A4<br>6.2L V8/M5/A4<br>6.5L V8/M5/A4 | 8600           | 3750/6000                        | 3759  | 10000/1000<br>10000/1000<br>8500/1000<br>9500/1000                 |
| <b>K3500 REGULAR CAB</b>   |  |                                   |                            |   |                |                                  |   |  |
| <b>SINGLE REAR WHEELS</b>  | CK30903/<br>ZW9                            | 3/2                               | 5.7L V8/M5                 | 5.7L V8/A4<br>7.4L V8/M5/A4<br>6.2L V8/M5/A4<br>6.5L V8/M5/A4 | 9200           | 3750/6084                        | 4518  | 9500/1000<br>10000/1000<br>8000/960<br>9000/1000                   |
| <b>DUAL REAR WHEELS</b>  | CK30903/<br>ZW9/R05                        | 3/2                               | 5.7L V8/M5                 | 5.7L V8/A4<br>7.4L V8/M5/A4<br>6.2L V8/M5/A4<br>6.5L V8/M5/A4 | 10000          | 3750/7500                        | 5089  | 9500/1000<br>10000/1000<br>8000/960<br>9000/1000                   |
| <b>DUAL REAR WHEELS<br/>"STRAIGHT FRAME"</b>                           | CK31003/<br>ZW9                            | 3/2                               | 5.7L V8/M5                 | 5.7L V8/A4<br>7.4L V8/M5/A4<br>6.2L V8/M5/A4<br>6.5L V8/M5/A4 | 10000          | 4500/7500                        | 4971  | 9500/1000<br>10000/1000<br>8000/960<br>9000/1000                   |
| <b>DUAL REAR WHEELS<br/>"STRAIGHT FRAME"<br/>HD</b>                    | CK31003/<br>ZW9/F44                        | 3/2                               | 5.7L V8/M5                 | 5.7L V8/A4<br>7.4L V8/M5/A4<br>6.2L V8/M5/A4<br>6.5L V8/M5/A4 | 12000          | 4500/8560                        | 6904  | 9500/1000<br>10000/1000<br>8000/960<br>9000/1000                   |
| <b>DUAL REAR WHEELS<br/>"STRAIGHT FRAME"<br/>LONG WHEELBASE</b>        | CK31403/<br>ZW9                            | 3/2                               | 5.7L V8/M5                 | 5.7L V8/A4<br>7.4L V8/M5/A4<br>6.2L V8/M5/A4<br>6.5L V8/M5/A4 | 10000          | 4500/7500                        | 4919  | 9500/1000<br>10000/1000<br>8000/960<br>9000/1000                   |
| <b>DUAL REAR WHEELS<br/>"STRAIGHT FRAME"<br/>LONG WHEELBASE<br/>HD</b> | CK31403/<br>ZW9/F44                        | 3/2                               | 5.7L V8/M5                 | 5.7L V8/A4<br>7.4L V8/M5/A4<br>6.2L V8/M5/A4<br>6.5L V8/M5/A4 | 12000          | 4500/8560                        | 6852  | 9500/1000<br>10000/1000<br>8000/960<br>9000/1000                   |

See the following page for additional 4WD models.

# C/K CHASSIS-CAB

| SERIES                                  | MODEL NUMBER/<br>BODY CODE/<br>OPTION CODE | PASSENGER CAPACITY<br>(STD./OPT.) | STANDARD ENGINE/<br>TRANS. | OPTIONAL ENGINE/<br>TRANS.                                    | GVWR<br>(LBS.) | GAWR<br>(LBS.)<br>FRONT/<br>REAR | MAXIMUM PAYLOAD<br>(LBS.)<br>BASED ON<br>CURB WT. | MAX. GROSS TRAILER WT./<br>TONGUE LOAD (LBS.)<br>PROPERLY EQUIPPED |
|---|--|-----------------------------------|----------------------------|---|----------------|----------------------------------|---|--|
| <b>FOUR -WHEEL DRIVE MODELS (CONT.)</b> |  |                                   |                            |   |                |                                  |   |  |
| <b>K3500 EXTENDED CAB</b>               |  |                                   |                            |   |                |                                  |   |  |
| <b>SINGLE REAR WHEELS</b>               | CK30953/<br>ZW9                            | 6/5/3                             | 5.7L V8/M5                 | 5.7L V8/A4<br>7.4L V8/M5/A4<br>6.2L V8/M5/A4<br>6.5L V8/M5/A4 | 9200           | 3750/6084                        | 4242  | 9500/1000<br>10000/1000<br>8000/960<br>9000/1000                   |
| <b>DUAL REAR WHEELS</b>                 | CK30953/<br>ZW9/R05                        | 6/5/3                             | 5.7L V8/M5                 | 5.7L V8/A4<br>7.4L V8/M5/A4<br>6.2L V8/M5/A4<br>6.5L V8/M5/A4 | 10000          | 3750/7500                        | 4813  | 9500/1000<br>10000/1000<br>8000/960<br>9000/1000                   |
| <b>K3500 CREW CAB</b>                   |  |                                   |                            |   |                |                                  |   |  |
| <b>SINGLE REAR WHEELS</b>               | CK30943/<br>ZW9                            | 6/5                               | 5.7L V8/M5                 | 5.7L V8/A4<br>7.4L V8/M5/A4<br>6.5L V8/M5/A4                  | 9200           | 4500/6084                        | 3848  | 9500/1000<br>10000/1000<br>9000/1000                               |
| <b>DUAL REAR WHEELS</b>                 | CK30943/<br>ZW9/R05                        | 6/5                               | 5.7L V8/M5                 | 5.7L V8/A4<br>7.4L V8/M5/A4<br>6.5L V8/M5/A4                  | 10000          | 4500/7500                        | 4421  | 9000/1000<br>10000/1000<br>9000/1000                               |

## POWERTRAINS

Chevrolet offers a variety of engines, transmissions and rear axle ratios for the C/K Chassis-Cab. The following charts detail basic engine, transmission and axle specifications. See your 1993 Chevrolet Truck Order Guide for details.

| ENGINES                                     |            |            |   |                           |                           |
|---|------------|------------|---|---------------------------|---------------------------|
|   | 5.7L V8 HD | 7.4L V8 HD | 6.2L V8 HD                                | 6.5L V8 TURBO DIESEL      |                           |
| Order Code                                  | L05        | L19        | LL4                                       | L65                       |                           |
| Availability                                | All Models | All Models | All except HD Chassis and Crew Cab Models | C/K 3500                  | HD Chassis                |
| SAE Net Horsepower @ rpm                    | 190 @ 4000 | 230 @ 3600 | 150 @ 3500                                | 190 @ 3400                | 180 @ 3400                |
| SAE Net Torque lbs-ft @ rpm                 | 300 @ 2400 | 385 @ 1600 | 280 @ 2000                                | 380 @ 1700                | 360 @ 1700                |
| Fuel System                                 | EFI        | EFI        | Gear Driven Mechanical FI                 | Gear Driven Mechanical FI | Gear Driven Mechanical FI |
| Clutch Size (in.)                           | 12         | 12         | 12  | 12                        | 12                        |
| Standard Battery Cold Cranking Amps @ 0°F   | 630        | 630        | 2 @ 570 each                              | 2 @ 570 each              | 2 @ 570 each              |
| Standard Alternator Maximum Capacity (Amps) | 100        | 100        | 100                                       | 100                       | 100                       |

| TRANSMISSIONS                       |  |                     |                     |                  |   |                     |                     |                  |
|-------------------------------------|--|---------------------|---------------------|------------------|---|---------------------|---------------------|------------------|
|                                     | MANUAL                                     |                     |                     |                  | AUTOMATIC   |                     |                     |                  |
|                                     | MANUAL 5-SPEED<br>W/OD HEAVY-DUTY (NP4500) |                     |                     |                  | ELECTRONICALLY CONTROLLED AUTOMATIC<br>4-SPEED W/OD HD (HM4L80-E) (MT1) |                     |                     |                  |
| Order Code                          | MT8  |                     |                     |                  | MX0   |                     |                     |                  |
| Availability                        | All  |                     |                     |                  | All   |                     |                     |                  |
| Engine Application/<br>(Order Code) | 5.7L V8 HD<br>(L05)                        | 7.4L V8 HD<br>(L19) | 6.2L V8 HD<br>(LL4) | 6.5L V8<br>(L65) | 5.7L V8 HD<br>(L05)   | 7.4L V8 HD<br>(L19) | 6.2L V8 HD<br>(LL4) | 6.5L V8<br>(L65) |
| Synchronized Speeds                 | 1/2/3/4/5                                  |                     |                     |                  | —   |                     |                     |                  |
| Gear Ratios                         |  |                     |                     |                  |   |                     |                     |                  |
| First                               | 6.34                                       |                     |                     |                  | 2.48  |                     |                     |                  |
| Second                              | 3.44                                       |                     |                     |                  | 1.48  |                     |                     |                  |
| Third                               | 1.71                                       |                     |                     |                  | 1.00  |                     |                     |                  |
| Fourth                              | 1.00                                       |                     |                     |                  | 0.75  |                     |                     |                  |
| Fifth                               | 0.73                                       |                     |                     |                  | —   |                     |                     |                  |
| Reverse                             | 6.34                                       |                     |                     |                  | 2.08  |                     |                     |                  |
| Power Take Off                      | Yes  |                     |                     |                  | No  |                     |                     |                  |



# C/K CHASSIS-CAB INTRODUCTION

## C/K CHASSIS-CAB

The C/K 2500 and 3500 Chassis-Cabs are available in two trim levels: the "Cheyenne" (standard) and the "Silverado" (uplevel). The exception is the C3500HD, which is only available in the "Cheyenne" trim level.

New for 1993 is the C/K 3500 Crew Cab Chassis-Cab with 9000 and 10,000-lbs GVWR on "C" models and 9200 and 10,000-lbs GVWR on "K" models.

Changes on the C/K Chassis-Cab include:

- The availability of 6.5L V8 Turbo Diesel (L65) has been increased to include C/K 2500 Extended Cab Chassis-Cabs at or above 8600-lbs GVWR and C/K 3500 Extended Cab Chassis-Cabs at or above 9000-lbs GVWR.
  - C3500HD Chassis-Cabs are replacing Rockwell rear axles with Dana rear axles.
  - Extended Cab Chassis-Cab models feature a standard front reclining 60/40 split 3-passenger bench seat.
  - Other standard features include improved corrosion protection, new Solar-Ray window glass and Scotchgard™ fabric protection on all cloth seats and trim.
-

## MODEL SELECTION SUMMARY

Use the chart below to choose the model that fits your needs. Note that the Maximum Payload is based on curb weight. Also, the Maximum Gross Trailer Weight is based on vehicles that are properly equipped. See your 1993 Chevrolet Truck Order Guide for details.

| SERIES   | MODEL NUMBER/<br>BODY CODE/<br>OPTION CODE | PASSENGER<br>CAPACITY<br>(STD./OPT.) | STANDARD<br>ENGINE/<br>TRANS. | OPTIONAL<br>ENGINE/<br>TRANS.                                 | GVWR<br>(LBS.) | GAWR<br>(LBS.)<br>FRONT/<br>REAR | MAXIMUM<br>PAYLOAD<br>(LBS.)<br>BASED ON<br>CURB WT. | MAX. GROSS<br>TRAILER WT./<br>TONGUE<br>LOAD (LBS.)<br>PROPERLY<br>EQUIPPED |
|--|--|--------------------------------------|-------------------------------|---|----------------|----------------------------------|--|---|
| <b>TWO-WHEEL DRIVE MODELS</b>  |  |                                      |                               |   |                |                                  |  |   |
| <b>C2500 REGULAR CAB</b>   |  |                                      |                               |   |                |                                  |  |   |
| <b>SINGLE REAR<br/>WHEELS</b>  | CC20903/<br>ZW9                            | 3/2                                  | 5.7L V8/M5                    | 5.7L V8/A4<br>7.4L V8/M5/A4<br>6.2L V8/M5/A4<br>6.5L V8/M5/A4 | 8600           | 3600/6000                        | 4453   | 9500/1000<br>10000/1000<br>8500/1000<br>10000/1000                          |
| <b>C2500 EXTENDED CAB</b>  |  |                                      |                               |   |                |                                  |  |   |
| <b>SINGLE REAR<br/>WHEELS</b>  | CC20953/<br>ZW9                            | 6/5/3                                | 5.7L V8/M5                    | 5.7L V8/A4<br>7.4L V8/M5/A4<br>6.2L V8/M5/A4<br>6.5L V8/M5/A4 | 8600           | 3600/6000                        | 4214   | 9500/1000<br>10000/1000<br>8500/1000<br>10000/1000                          |
| <b>C3500 REGULAR CAB</b>   |  |                                      |                               |   |                |                                  |  |   |
| <b>SINGLE REAR<br/>WHEELS</b>  | CC30903/<br>ZW9                            | 3/2                                  | 5.7L V8/M5                    | 5.7L V8/A4<br>7.4L V8/M5/A4<br>6.2L V8/M5/A4<br>6.5L V8/M5/A4 | 9000           | 3600/6084                        | 4691   | 10000/1000<br>10000/1000<br>8500/1000<br>9500/1000                          |
| <b>DUAL REAR<br/>WHEELS</b>  | CC30903/<br>ZW9/R05                        | 3/2                                  | 5.7L V8/M5                    | 5.7L V8/A4<br>7.4L V8/M5/A4<br>6.2L V8/M5/A4<br>6.5L V8/M5/A4 | 10000          | 3600/7500                        | 5476   | 10000/1000<br>10000/1000<br>8500/1000<br>9500/1000                          |
| <b>DUAL REAR<br/>WHEELS<br/>"STRAIGHT FRAME"</b>                           | CC31003/<br>ZW9                            | 3/2                                  | 5.7L V8/M5                    | 5.7L V8/A4<br>7.4L V8/M5/A4<br>6.2L V8/M5/A4<br>6.5L V8/M5/A4 | 10000          | 3880/7500                        | 5386   | 10000/1000<br>10000/1000<br>8500/1000<br>9500/1000                          |
| <b>DUAL REAR<br/>WHEELS<br/>"STRAIGHT FRAME"<br/>HD</b>                    | CC31003/<br>ZW9/F44                        | 3/2                                  | 5.7L V8/M5                    | 5.7L V8/A4<br>7.4L V8/M5/A4<br>6.2L V8/M5/A4<br>6.5L V8/M5/A4 | 11000          | 4100/8250                        | 6335   | 10000/1000<br>10000/1000<br>8500/1000<br>9500/1000                          |
| <b>DUAL REAR<br/>WHEELS<br/>"STRAIGHT FRAME"<br/>LONG<br/>WHEELBASE</b>    | CC31403/<br>ZW9                            | 3/2                                  | 5.7L V8/M5                    | 5.7L V8/A4<br>7.4L V8/M5/A4<br>6.2L V8/M5/A4<br>6.5L V8/M5/A4 | 10000          | 3880/7500                        | 5318   | 10000/1000<br>10000/1000<br>8500/1000<br>9500/1000                          |
| <b>DUAL REAR<br/>WHEELS<br/>"STRAIGHT FRAME"<br/>LONG<br/>WHEELBASE HD</b> | CC31403/<br>ZW9/F44                        | 3/2                                  | 5.7L V8/M5                    | 5.7L V8/A4<br>7.4L V8/M5/A4<br>6.2L V8/M5/A4<br>6.5L V8/M5/A4 | 11000          | 4100/8250                        | 6267   | 10000/1000<br>10000/1000<br>8500/1000<br>9500/1000                          |
| <b>C3500 EXTENDED CAB</b>  |  |                                      |                               |   |                |                                  |  |   |
| <b>SINGLE REAR<br/>WHEELS</b>  | CC30953/<br>ZW9                            | 6/5/3                                | 5.7L V8/M5                    | 5.7L V8/A4<br>7.4L V8/M5/A4<br>6.2L V8/M5/A4<br>6.5L V8/M5/A4 | 9000           | 3600/6084                        | 4420   | 10000/1000<br>10000/1000<br>8500/1000<br>9500/1000                          |
| <b>DUAL REAR<br/>WHEELS</b>  | CC30953/<br>ZW9/R05                        | 6/5/3                                | 5.7L V8/M5                    | 5.7L V8/A4<br>7.4L V8/M5/A4<br>6.2L V8/M5/A4<br>6.5L V8/M5/A4 | 10000          | 3600/7500                        | 5205   | 10000/1000<br>10000/1000<br>8500/1000<br>9500/1000                          |

See the following pages for additional 2WD and 4WD models.

# C/K PICKUP

## SPECIAL EQUIPMENT OPTIONS (CONT.)

|  | LEAD TIME<br>(DAYS) | OPTION<br>CODE |
|--|---------------------|----------------|
| <b>Mirror, Outside Rearview</b><br>(Veivac 6.5" x 10" Plain and 6.5" x 6.0" Convex, each side. Inside dimension of 77.")   |                     |                |
| Black  | 0                   | 6P3            |
| Stainless Steel  | 0                   | 6N9            |
| <b>Mirror, Outside Rearview</b><br>(Veivac Wideloop 6.5" x 10" Plain and 6.5" x 6" Convex, each side. Inside dimension of 96.")                                      |                     |                |
| White  | 0                   | 8B2            |
| Stainless Steel  | 0                   | 8G9            |
| <b>Mirror, Outside Rearview</b><br>(Veivac 6.5" x 6.0" Convex Dual Spot — Stainless Steel. Available only w/West Coast Mirrors DG5.)                                 | 0                   | 9J7            |
| <b>Mirror, Outside Rearview</b><br>(Veivac West Coast Type stainless steel.)   | 0                   | 9F8            |
| <b>Ornamentation Delete</b><br>C.K 10703 only.   | 0                   | 8F2            |
| <b>Paints: Solid.</b>  |                     |                |
| <b>Orange, Tangier</b> WE9417  | 0                   | 9W4            |
| <b>Yellow, Wheatland</b> WE9418  | 0                   | 9W3            |
| <b>Green, Woodland</b> WE9015  | 0                   | 9V5            |
| <b>Tan, Doeskin</b> WE9403   | 0                   | 9V9            |
| <b>Seats, Front Deletion</b><br>(retains LH/RH bucket type seat belts only. Rear seat remains in Extended Cab except when solid front bench seat trim is specified.) | 0                   | 8E2            |
| <b>Seat, Restraint, Front</b><br>(dual mode retractor. Available in Blue or Beige only. N/A Bucket Seats or Silverado Trim.)   | 42                  | 9L8            |
| <b>Seats, Bucket</b><br>w/o Center Console.  | 42                  | 8W7            |
| <b>Seats, Rear Non-Installed</b><br>Extended Cab only.   | 0                   | 8Q3            |
| <b>Shock Absorbers, Front and Rear Delco/Bilstein</b><br>(46mm gas pre-loaded. C10703/10903 only.)   | 42                  | 8X7            |
| <b>Spring, Front Suspension</b><br>(provides higher production rated spring for Hy-Rail railroad operation.)   | 42                  | 8W9            |
| <b>Spring, Rear Auxiliary</b><br>(for vehicle trim adjustment. C20903 only. Rated at 6000-pound GAWR.)   | 0                   | 5J9            |
| <b>Steering Column, Tilt</b>   | 42                  | 9J6            |
| <b>Switch, Dome Lamp</b><br>(RH door operated.)  | 0                   | 8M3            |
| <b>Throttle, Hand</b><br>(adjustable pull type.)   | 0                   | 7L4            |

**DIMENSIONS**

| MODEL                                     | C/K 1500 PICKUP<br>REG. CAB/EXT. CAB<br>SPORTSIDE/FLEETSIDE |                        |       | C/K2500 PICKUP<br>REG. CAB/EXT. CAB<br>FLEETSIDE |  |                        | C/K3500 PICKUP<br>REG. CAB/ EXT.<br>CAB FLEETSIDE |                        | C/K 3500 PICKUP<br>CREW CAB |             |          |
|---|---|------------------------|-------|--|--|------------------------|---|------------------------|-----------------------------|-------------|----------|
|   | C/K 10703<br>C/K 10753                                      | C/K 10903<br>C/K 10953 |       | C/K 20753  |  | C/K 20903<br>C/K 20953 |   | C/K 30903<br>C/K 30953 |                             | C/K 30943   |          |
| MODEL NUMBER                              | E62   | E63                    | E63   |  |  | C6P                    |   | C6U<br>& C6W           | C7A<br>(OPT.)               | R04         | R05      |
| <b>EXTERIOR DIMENSIONS</b>                |   |                        |       |  |  |                        |   |                        |                             |             |          |
| <b>BODY</b>                               |   |                        |       |  |  |                        |   |                        |                             |             |          |
| Wheelbase (in.)                           |   |                        |       |  |  |                        |   |                        |                             |             |          |
| Reg. Cab                                  | 117.5   |                        | 131.5 | —  |  | 131.5                  |   | 131.5                  | 131.5                       | 168.5       |          |
| Ext. Cab                                  | 141.5   |                        | 155.5 | 141.5  |  | 155.5                  |   | 155.5                  | 155.5                       | —           |          |
| Overall Length (in.) w/o<br>Rear Bumper   |   |                        |       |  |  |                        |   |                        |                             |             |          |
| Reg. Cab                                  | 194.1   |                        | 212.6 | —  |  | 212.6                  |   | 212.6                  |                             | 255.4       |          |
| Ext. Cab                                  | 218.0   |                        | 237.0 | 218.0  |  | 237.0                  |   | 237.0                  |                             | —           |          |
| Overall Height (in.)                      |   |                        |       |  |  |                        |   |                        |                             |             |          |
| Nominal - Reg. Cab                        | 2WD 70.4  |                        |       | —  |  | 2WD 73.0               | 2WD 75.5  | 2WD 75.5               |                             | 2WD 71.7    | 2WD 70.8 |
|   | 4WD 73.8  |                        |       | —  |  | 4WD 74.3               | 4WD 75.8  | 4WD 75.8               |                             | 4WD 71.7    | 4WD 70.8 |
| Nominal - Ext. Cab                        | 2WD 70.6  |                        |       | 2WD 74.0   |  | 2WD 74.0               | 2WD 75.6  | 2WD 75.6               |                             | —           | —        |
|   | 4WD 73.6  |                        |       | 4WD 74.4   |  | 4WD 74.4               | 4WD 75.8  | 4WD 75.8               |                             | —           | —        |
| Maximum Width (in.)                       | 77.1  | 76.8                   | 76.8  | 76.8   |  | 76.8                   |   | 76.8                   | 94.2                        | 76.8        | 94.2     |
| Bumper To Axle (in.)                      |   |                        |       |  |  |                        |   |                        |                             |             |          |
| Front                                     | 34.9  |                        |       | 34.9   |  | 34.9                   |   | 34.9                   |                             | 34.9        |          |
| Rear Overhang<br>(w/o bumper)             | 47.3  |                        |       | 52.2   |  | 47.3                   |   | 52.2                   |                             | 46.5        |          |
| Cab Axle (in.)                            | 42.0  |                        |       | 56.0   |  | 41.8                   |   | 56.0                   |                             | 55.9        |          |
| Cab to End of Frame (in.)                 | 78.7  |                        |       | 97.6   |  | 78.7                   |   | 97.6                   |                             | 97.0        |          |
| Bumper to Back of Cab (in.)               |   |                        |       |  |  |                        |   |                        |                             |             |          |
| Reg. Cab                                  | 110.6   |                        |       | —  |  | 110.6                  |   | 110.6                  |                             | 147.6       |          |
| Ext. Cab                                  | 134.6   |                        |       | 134.6  |  | 134.6                  |   | 134.6                  |                             | —           |          |
| Ground to Top of<br>Rear Load Floor (in.) |   |                        |       |  |  |                        |   |                        |                             |             |          |
|   | 2WD 29.0  |                        |       | 2WD 31.6   |  | 2WD 31.6               | 2WD 34.2  | 2WD 34.0               |                             | 2WD 29.9    | 2WD 29.2 |
|   | 4WD 32.4  |                        |       | 4WD 32.9   |  | 4WD 32.9               | 4WD 34.4  | 4WD 34.4               |                             | 4WD 29.9    | 4WD 29.2 |
| Ground Clearance (in.)                    |   |                        |       |  |  |                        |   |                        |                             |             |          |
| Front/Rear                                |   |                        |       |  |  |                        |   |                        |                             |             |          |
| Reg. Cab                                  | 2WD 7.0/8.4   |                        |       | —  |  | 2WD 7.8/7.8            | 2WD 8.4/8.1                                       | 2WD 7.9/7.6            |                             | 8.0/7.7     |          |
|   | 4WD 8.6/9.0   |                        |       | —  |  | 4WD 8.7/7.7            | 4WD 7.8/8.1                                       | 4WD 7.2/7.4            |                             | 8.0/7.7     |          |
| Ext. Cab                                  | 2WD 7.2/7.1   |                        |       | 2WD 7.9/7.7                                      |  | 2WD 7.9/7.7            | 2WD 8.4/8.0                                       | 2WD 7.9/7.6            |                             | —           |          |
|   | 4WD 9.2/9.6   |                        |       | 4WD 9.2/8.2                                      |  | 4WD 9.2/8.1            | 4WD 9.2/8.1                                       | 4WD 7.2/7.4            |                             | —           |          |
| <b>CARGO BOX</b>                          |   |                        |       |  |  |                        |   |                        |                             |             |          |
| Inside Length at Floor (in.)              | 78.7  |                        |       | 97.6   |  | 78.6                   |   | 97.6                   |                             | 96.1        |          |
| Inside Width at Top (in.) Rear            | 49.1  | 61.9                   | 61.9  | 61.9   |  | 61.9                   |   | 61.9                   |                             | 65.0        |          |
| Inside Width at Floor (in.)               | 49.1  | 64.7                   | 64.7  | 64.7   |  | 64.7                   |   | 64.7                   |                             | 64.8        |          |
| Inside Width at<br>Wheelhousing (in.)     | 49.1  |                        |       | 49.1   |  | 49.1                   |   | 49.1                   |                             | 49.1        |          |
| Inside Height (in.)                       | 19.3  |                        |       | 19.3   |  | 19.3                   |   | 19.3                   |                             | 19.2        |          |
| Tailgate Width (in.) (Top)                | 50.9  | 62.0                   | 62.0  | 62.0   |  | 62.0                   |   | 62.0                   |                             | 62.0        |          |
| <b>SIGN PANEL AREA (in.)</b>              |   |                        |       |  |  |                        |   |                        |                             |             |          |
| Reg. Cab                                  | 17 x 48 3/4   |                        |       | 17 x 48 3/4                                      |  | 17 x 48 3/4            |   | 17 x 48 3/4            |                             | —           |          |
| Ext. Cab                                  | 17 x 77 1/2   |                        |       | 17 x 77 1/2                                      |  | 17 x 77 1/2            |   | 17 x 77 1/2            |                             | —           |          |
| Crew Cab                                  | —   |                        |       | —  |  | —                      |   | —                      |                             | 17 x 85 3/4 |          |

**INTERIOR DIMENSIONS**

| <b>CAB</b>                              |        |  |  |        |  |        |  |        |  |           |  |
|---|--------|--|--|--------|--|--------|--|--------|--|-----------|--|
| Headroom (in.) Front/Rear               | 40.0/— |  |  | 40.0/— |  | 40.0/— |  | 40.0/— |  | 40.1/40.8 |  |
| Legroom (in.) Front/Rear                | 41.7/— |  |  | 41.7/— |  | 41.7/— |  | 41.7/— |  | 41.8/39.2 |  |
| Shoulder Room (in.)                     |        |  |  |        |  |        |  |        |  |           |  |
| Front/Rear                              | 66.0/— |  |  | 66.0/— |  | 66.0/— |  | 66.0/— |  | 66.0/66.1 |  |
| Hip Room (in.) Front/Rear               | 60.7/— |  |  | 60.7/— |  | 60.7/— |  | 60.7/— |  | 60.5/59.6 |  |
| Ext. Cab                                |        |  |  |        |  |        |  |        |  |           |  |
| Cargo Volume (cu. ft.)<br>w/o Rear Seat | 40.5   |  |  | 40.5   |  | 40.5   |  | 40.5   |  | —         |  |

# C/K PICKUP

## PREFERRED EQUIPMENT GROUPS

Preferred Equipment Groups (PEGs) are convenient option packages that can save your customers money. They would pay appreciably more by buying all the options in a Preferred Equipment Group as individual options. (Savings based on a comparison of Manufacturer's Suggested Retail Price of option packages versus MSRP of individual options purchased separately.) See your 1993 Chevrolet Truck Order Guide and Vehicle Price Schedule for specific information and prices.

## OPTIONS

These options can be ordered individually in addition to the Preferred Equipment Groups if not already included. See your 1993 Chevrolet Truck Order Guide for specific availability and restrictions. The Option Code is listed in **bold type**.

|   |            |   |            |  |                  |
|---|------------|---|------------|--|------------------|
| Air Conditioning .....  | <b>C60</b> | 6.2L V8 Diesel .....  | <b>LL4</b> | ETR AM Radio .....   | <b>UT5</b>       |
| Appearance Package: Chrome Grille,<br>Composite Headlamps & Dual<br>Horns(Incl. w/Silverado Decor) .....                        | <b>V22</b> | 6.5L V8 Turbo Diesel .....  | <b>L65</b> | ETR AM/FM Stereo Radio<br>w/Seek-Scan, Stereo Cassette/<br>Digital Clock .....   | <b>UM6</b>       |
| Axles, Rear (see Order Guide for GQ1):<br>3.08 .....  | <b>GU4</b> | Alternative Fuel (LPG or CNG<br>Conversion Ready) .....   | <b>KL5</b> | ETR AM/FM Stereo Radio w/<br>Seek-Scan/Digital Clock .....   | <b>UM7</b>       |
| 3.42 .....  | <b>GU6</b> | Floor Covering<br>Full Floor Rubber, Color-Keyed .....  | <b>BG9</b> | ETR AM/FM Stereo Radio w/<br>Seek-Scan/Stereo Cassette with<br>Search/Repeat, Graphic<br>Equalizer/Digital Clock .....                                       | <b>UX1</b>       |
| 3.73 .....  | <b>GT4</b> | Glass, Deep Tinted, Sides and Rear<br>(Extended and Crew Cab only,<br>includes Swing-Out Windows A20<br>on Extended Cab) .....                | <b>AJ1</b> | Seat, Power Driver's Adjuster<br>(Crew Cab only) .....   | <b>AG9</b>       |
| 4.10 .....  | <b>GT5</b> | GVWR (non-merchandise codes<br>for information only):<br>5600 lbs .....   | <b>C5G</b> | Seat, Rear 3-Passenger Bench<br>not desired (Extended Cab Only) .....  | <b>YG4</b>       |
| 4.56 .....  | <b>HC4</b> | 6100 lbs .....  | <b>C5M</b> | Shock Absorbers, Front and Rear,<br>Heavy-Duty (included w/Trailer<br>Special Equipment Z82) .....   | <b>F51</b>       |
| Axle, Rear Locking Differential .....   | <b>G80</b> | 6200 lbs .....  | <b>Q4B</b> | Skid Plate (4x4 only) .....  | <b>NZZ</b>       |
| Battery, Heavy-Duty, Auxiliary .....  | <b>TP2</b> | 6600 lbs .....  | <b>C5S</b> | Snow Plow Prep Package<br>(Reg. Cab 4x4 only) .....  | <b>VYU</b>       |
| Bedliner .....  | <b>BZY</b> | 7200 lbs .....  | <b>C5Z</b> | Sport Equipment Package .....  | <b>BYP</b>       |
| Bonus packages:<br>(Manual Transmission only)<br>Work Package .....   | <b>R9A</b> | 8600 lbs .....  | <b>C6P</b> | Sport Performance Package,<br>454SS Model .....  | <b>B4U</b>       |
| Convenience Package .....   | <b>R9C</b> | 9000 lbs .....  | <b>C6U</b> | Springs, Front Heavy-Duty (4x4 only) ..  | <b>F60</b>       |
| Delete .....  | <b>R9D</b> | 9200 lbs .....  | <b>C6W</b> | Sport Handling Package (includes 46mm<br>Bilstein gas-filled shocks and<br>chrome wheels N83, C1500 only) .....  | <b>ZQ8</b>       |
| Bumper, Painted Rear Step .....   | <b>V43</b> | 9600 lbs .....  | <b>C6Y</b> | Tachometer .....   | <b>U16</b>       |
| Bumper, Chromed Rear Step<br>w/ Rub Strip .....   | <b>VB3</b> | 10,000 lbs .....  | <b>C7A</b> | Tow Hooks, Front (4x2 only) .....  | <b>V76</b>       |
| Bumper, Chromed Front Deluxe<br>w/Rub Strip .....   | <b>VG3</b> | Harness, Wiring (seven-lead,<br>included w/Trailer Special<br>Equipment Z82) .....  | <b>UY7</b> | Trailer Special Equipment<br>(includes seven-lead wiring harness,<br>weight distributing hitch platform,<br>and other equipment depending on<br>model) ..... | <b>Z82</b>       |
| Bumper Guards, Front, Black .....   | <b>V27</b> | Lamps, Cargo Area .....   | <b>UF2</b> | Transmissions<br>5-Speed Manual<br>w/overdrive .....   | <b>MM5(MG5)</b>  |
| Camper Special Chassis Equipment<br>(Includes Camper Mirrors DF2,<br>seven-lead Wiring Harness,<br>Auxiliary Battery TP2) ..... | <b>Z81</b> | Lamps, Dome and Reading<br>(included w/Auxiliary Lighting TR9) ..   | <b>C95</b> | 5-Speed Manual with Deep Low<br>and Overdrive, H.D. ....   | <b>MT8</b>       |
| Carrier, Spare Wheel & Tire<br>(side mounted) .....   | <b>P13</b> | Lamps, Roof Marker (included<br>w/Dual Rear Wheels R05) .....   | <b>U01</b> | 4-Speed Electronic Automatic<br>with OD and torque converter<br>clutch .....   | <b>MX0 (M30)</b> |
| Cold Climate Package<br>(includes Engine Block Heater,<br>antifreeze protection to -32°F and<br>special insulation) .....       | <b>V10</b> | License Plate Bracket, Front .....  | <b>VK3</b> | 4-Speed Electronically<br>Controlled Automatic<br>w/Overdrive, H.D. ....   | <b>MX0 (MT1)</b> |
| Convenience Package, Driver's<br>(includes ComfortTilt™ Steering<br>and Electronic Speed Control) .....                         | <b>ZQ3</b> | Lighting Auxiliary (dome, reading,<br>ashtray, glove box and underhood<br>lamps) .....  | <b>TR9</b> | Wheel Covers .....   | <b>P01</b>       |
| Convenience Package, Operating<br>(includes Power Door Locks and<br>Power Windows) .....  | <b>ZQ2</b> | Mirrors, Exterior, Below-eye-line<br>Type (LH and RH stainless steel,<br>Mirror head 9.0" x 6.5") .....                                       | <b>D45</b> | Wheels<br>Rally Trim .....   | <b>P06</b>       |
| Cooling System<br>Engine Oil Cooler .....   | <b>KC4</b> | Mirrors, Exterior, Remote Control<br>Below-eye-line, Electric,<br>Painted (Crew Cab) .....  | <b>D48</b> | Cast Aluminum (15" x 7") .....   | <b>N90</b>       |
| Heavy-Duty Radiator .....   | <b>V01</b> | Mirrors, Exterior Camper Type<br>(LH and RH stainless steel, Mirror<br>head: 7.5" x 10.5", included w/<br>Camper Special Equipment Z81) ..... | <b>DF2</b> | Cast Aluminum (16" x 7") .....   | <b>PF4</b>       |
| Heavy-Duty Radiator and<br>Transmission Oil Cooler .....  | <b>V02</b> | Moldings, Body Side and Wheel<br>Opening (Black) .....  | <b>B84</b> | Chrome Wheels (C1500) .....  | <b>N83</b>       |
| Defogger, Rear Windows<br>(Extended and Crew Cab Only) .....  | <b>C49</b> | Off-Road Chassis Package (K1500 only)<br>(includes Bilstein 46mm shocks<br>and skid plate NZZ) .....  | <b>Z71</b> | Dual Rear (C/K3500 only) .....   | <b>R05</b>       |
| Emission Systems<br>Standard .....  | <b>NA5</b> | Paint, Exterior<br>Solid .....  | <b>ZY1</b> | Windows, Sliding Rear .....  | <b>A28</b>       |
| High Altitude .....   | <b>NA6</b> | Conventional Two-Tone .....   | <b>ZY2</b> | Windows, Swing-Out Quarter<br>(Extended Cab) .....   | <b>A20</b>       |
| California .....  | <b>YF5</b> | Deluxe Two-Tone .....   | <b>ZY4</b> | Work Truck Package .....   | <b>VLA</b>       |
| Engines:<br>4.3L V6 EFI .....   | <b>LB4</b> | Pick-up Box Delete .....  | <b>ZW9</b> |  |                  |
| 5.0L V8 EFI .....   | <b>L03</b> | Radio Equipment:<br>Radio Delete .....  | <b>UL5</b> |  |                  |
| 5.7L V8 EFI .....   | <b>L05</b> |   |            |  |                  |
| 7.4L V8 EFI .....   | <b>L19</b> |   |            |  |                  |
| 6.2L V8 Diesel .....  | <b>LH6</b> |   |            |  |                  |

## TIRES

**KEY: AS = ALL-SEASON SBR = STEEL-BELTED RADIAL PLY BW = BLACKWALL WW = WHITEWALL WL = WHITE LETTERED  
HWY = HIGHWAY BL = BLACK LETTERED ON-OFF = ON-OFF ROAD WOL = WHITE OUTLINE LETTERED**

|              |                  | FRONT | REAR | SPARE |
|--------------|------------------|-------|------|-------|
| P225/75R15   | AS/SBR/WL        | XEV   | YEV  | ZEV   |
| P225/75R15   | AS/SBR/BW        | XET   | YET  | ZET   |
| P235/75R15   | AS/SBR/BW        | XFL   | YFL  | ZFL   |
| P235/75R15   | AS/SBR/WW        | XFM   | YFM  | ZFM   |
| P235/75R15   | AS/SBR/WL        | XFN   | YFN  | ZFN   |
| P275/60R15   | AS/SBR/BW        | XCN   | YCN  | ZCN   |
| LT225/75R16C | AS/SBR/BL        | XHE   | YHE  | ZHE   |
| LT225/75R16C | ON-OFF/SBR/BW    | XHJ   | YHJ  | ZHJ   |
| LT225/75R16C | ON-OFF/SBR/WOL   | XHN   | YHN  | ZHN   |
| LT225/75R16D | AS/SBR/BW        | XHP   | YHP  | ZHP   |
| LT225/75R16D | ON-OFF/AS/SBR/BW | XHR   | YHR  | ZHR   |
| LT245/75R16C | AS/SBR/BW        | XBK   | YBK  | ZBK   |
| LT245/75R16C | ON-OFF/SBR/BW    | XBN   | YBN  | ZBN   |
| LT245/75R16C | ON-OFF/SBR/WL    | XBX   | YBX  | ZBX   |
| LT245/75R16E | AS/SBR/BW        | XHH   | YHH  | ZHH   |
| LT245/75R16E | ON-OFF/SBR/BW    | XGK   | YGK  | ZGK   |
| LT265/75R16C | ON-OFF/SBR/BW    | XGL   | YGL  | ZGL   |
| LT265/75R16C | ON-OFF/SBR/WOL   | XGM   | YGM  | ZGM   |
| 7.50-16D     | HWY/NYLON/BW     | XDE   | YDE  | ZDE   |
| 7.50-16D     | ON-OFF/NYLON/BW  | XDL   | YDL  | ZDL   |

## SPECIAL EQUIPMENT OPTIONS

The following special equipment is installed at the assembly plant. See your 1993 SEO catalog for details.

| SPECIAL EQUIPMENT OPTIONS  |                     |                          |
|--|---------------------|--------------------------|
|  | LEAD TIME<br>(DAYS) | OPTION<br>CODE           |
| <b>Antifreeze, Permanent</b><br>(ethylene glycol protection to -34°F)  | 0                   | <b>8B3</b>               |
| <b>Axle, Rear Full Floating</b><br>(C/K20903-20953/C6P only)   | 0                   | <b>1TA</b>               |
| <b>Bumper</b><br>Front Painted Black.<br>Front Delete.   | 42<br>0             | <b>8E8</b><br><b>8H5</b> |
| <b>Carrier and Wheel, Spare</b><br>Does not include spare tire (C/K2500 and 3500 only, located under frame at rear).                                   | 42                  | <b>5V1</b>               |
| <b>Cold Climate Package</b><br>(diesel models only, C/K2500 and 3500 only, N/A C/K20753. Provides use of Arctic grade fuel).                           | 42                  | <b>8N1</b>               |
| <b>Cruise Control, Automatic</b>   | 42                  | <b>5K3</b>               |
| <b>Generator</b><br>Delco 105-Amp (Requires 5.7L V8, 6.2L V8 or 7.4L V8)<br>Delco 124-Amp (Requires 5.0L V8 or 5.7L V8)                                | 42<br>42            | <b>8W5</b><br><b>8A3</b> |
| <b>Headlamps-on Warning</b><br>(included with Auxiliary Lighting TR9)  | 0                   | <b>9W7</b>               |
| <b>Horn, High Note</b>   | 0                   | <b>7Z1</b>               |
| <b>Meter, Engine Hour</b>  | 42                  | <b>7Y4</b>               |
| <b>Mirror Delete, Outside Rearview</b>   | 0                   | <b>9F2</b>               |
| <b>Mirror, Outside Rearview</b><br>(Velvac 6.5" x 6.0" Plain and 6.5" x 6.0" Convex, each side. Inside dimension of 77")<br>Black.<br>Stainless Steel. | 0<br>0              | <b>6M1</b><br><b>6L8</b> |

# C/K PICKUP

## CHASSIS EQUIPMENT (CONT.)

| KEY: ■ = STANDARD, — = NOT INCLUDED |   | CHEYENNE<br>(STANDARD) | SILVERADO<br>(YE9) |
|-------------------------------------|---|------------------------|--------------------|
| SHOCK ABSORBERS                     | 25mm: C/K 1500 front and rear;<br>32mm: Front on C/K2500 at 7200 lbs. GVWR and C/K3500. Rear on C/K2500 and 3500;<br>35mm: Front on C/K2500 at 8600 lbs. GVWR and Crew Cab. | ■                      | ■                  |
| STABILIZER BAR                      | 4x2: Front 1.25-inch; 4x4: Front 1.18-inch.   | ■                      | ■                  |
| STEERING                            | Integral power.   | ■                      | ■                  |
| SUSPENSION, FRONT                   | 4x2: Independent with computer-selected coil springs.<br>4x4: Independent with computer-selected torsion springs.   | ■<br>■                 | ■<br>■             |
| SUSPENSION, REAR                    | C/K1500 and 2500: Semi-elliptic two-stage multi-leaf springs.<br>C/K3500: Semi-elliptic two-stage multi-leaf springs main/auxiliary.  | ■<br>■                 | ■<br>■             |
| TOW HOOKS                           | Two front on 4x4 s.   | ■                      | ■                  |

## EXTERIOR EQUIPMENT

|                      |  |             |             |
|----------------------|--|-------------|-------------|
| AIR DAM              | Black (not included on models at or above 8600 lbs. GVW).  | ■           | ■           |
| BUMPER, FRONT        | Chrome (w/black rub strip on Crew Cab).<br>Chrome with black rub strip with bright trim.   | ■<br>—      | —<br>■      |
| GRILLE               | Molded plastic painted light argent with dark argent air intakes areas.<br>Deluxe dark argent grille with bright trim.   | ■<br>—      | —<br>■      |
| HEADLAMPS            | Single rectangular halogen.<br>Dual composite halogen.   | ■<br>—      | —<br>■      |
| HORN                 | Single electric low-note.<br>Dual low- and high-note.  | ■<br>—      | —<br>■      |
| INSULATION           | Hood and cab-to-fender.  | —           | ■           |
| MIRRORS              | RH and LH below-eye-line type with adjustable heads, painted black.<br>Chrome RH and LH below-eye-line type with adjustable heads (Crew Cab only).<br>Head size 9.0" x 6.5"  | ■<br>—      | ■<br>■      |
| MOLDINGS             | Black bodyside with bright trim and bright wheel opening (except K2500 C6P, K3500 and Sportside).<br>Crew Cab: Black trim with wheel opening molding (R04).  | —<br>■      | ■<br>—      |
| SPARE TIRE AND WHEEL | Full-size on C/K1500. Optional on WT 1500, C/K2500 and 3500.   | ■           | ■           |
| SPARE TIRE CARRIER   | Winch-type carrier mounted under frame at rear. (C/K1500 only. Optional on WT 1500, C/K2500 and 3500.)   | ■           | ■           |
| TIRES                | Steel Belted Radials.<br>C/K1500 Reg. Cab (2WD) P225/75R15<br>Ext. Cab (2WD) P235/75R15<br>Reg. Cab (4WD) LT225/75R16C<br>Ext. Cab (4WD) LT245/75R16C<br>C/K2500 Reg. Cab (2WD)/(4WD) and Ext. Cab (2WD) LT225/75R16D<br>Ext. Cab (4WD) LT245/75R16C<br>All models with C6P LT245/75R16E<br>C/K3500 Reg. Cab, Ext. Cab and Crew Cab w/R04 LT245/75R16E<br>Reg. Cab and Ext. Cab (2WD) w/R05 LT225/75R16C/D<br>Reg. Cab, Ext. Cab (4WD) and Crew Cab R05 LT245/75R16D | ■           | ■           |
| WHEELS               | Argent painted steel wheels with black hub ornament.<br>15.0" x 6.0": C/K 1500 (2WD)<br>16.0" x 6.5": C/K 1500 (4WD), C/K 2500, C/K 3500 w/R04,<br>C/K 3500 w/R05 (front only)<br>16.0" x 6.0" C/K 3500 w/R05 (rear only)<br>Rally wheel trim.<br>Crew Cab: Full wheel covers, N/A R05.  | ■<br>—<br>— | —<br>■<br>■ |

## INTERIOR EQUIPMENT

| KEY: ■ = STANDARD, — = NOT INCLUDED     |   | CHEYENNE<br>(STANDARD) | SILVERADO<br>(YE9) |
|---|---|------------------------|--------------------|
| <b>ARMRESTS</b>                         | RH and LH padded integral with door panels.   | ■                      | ■                  |
| <b>BUZZER</b>                           | Headlamp warning.   | ■                      | ■                  |
| <b>CAB BACK PANELS</b>                  | Color-keyed carpet.   | —                      | ■                  |
| <b>CIGARETTE LIGHTER</b>                | Located on instrument panel.  | ■                      | ■                  |
| <b>CUP HOLDER</b>                       | Under dash. N/A with bucket seats.  | ■                      | ■                  |
| <b>DOMELAMP</b>                         | Switch in LH door jamb only (Two dome lamps with front door actuated switches on Crew Cab).<br>Switches in RH & LH front door jambs (Crew Cab includes switches in all four doors).   | ■<br>—                 | —<br>■             |
| <b>DOOR PANELS</b>                      | Grained molded plastic.<br>Special color-keyed door trim panels with decorative inserts, map pockets, padded armrests and carpet trim.  | ■<br>—                 | —<br>■             |
| <b>DOOR PILLAR AND ROOF SIDE PANELS</b> | Color-keyed.  | —                      | ■                  |
| <b>DOOR SILL PLATE</b>                  | Color-keyed.  | ■                      | ■                  |
| <b>FLOOR COVERING</b>                   | Embossed black rubber mat.<br>Color-keyed front and rear. Removable color-keyed floor mats.   | ■<br>—                 | —<br>■             |
| <b>GAGES</b>                            | Including fuel level, odometer, oil pressure, speedometer, tailtale lights, engine temperature and voltmeter.   | ■                      | ■                  |
| <b>GLOVE BOX</b>                        | Latched door and beverage holder.   | ■                      | ■                  |
| <b>HEADLINER</b>                        | Vinyl with matching retainer moldings.<br>Full-length color-keyed cloth with matching retainer moldings.<br>Crew Cab: Full-length color-keyed cloth with matching retainer moldings, and three assist handles (RF, LR, RR).   | ■<br>—<br>■            | —<br>■<br>■        |
| <b>HEATER</b>                           | Deluxe with windshield and side window defoggers.   | ■                      | ■                  |
| <b>INSULATION</b>                       | Provided on dash panels, cowl tops and sides, and doors. Extended Cabs have additional insulation on the rear quarter and back panels and on floor coverings. Extra insulation is provided with diesel engines.<br>Plus insulation on headliners.<br>Plus insulation on Regular Cab back panels.  | ■<br>—<br>—            | ■<br>■<br>■        |
| <b>MIRRORS</b>                          | 10-inch rearview.   | ■                      | ■                  |
| <b>RADIO</b>                            | Electronically-tuned AM radio with two 4" x 6" standard front dash speakers and fixed mast antenna.<br>ETR AM/FM stereo radio with seek-scan and digital clock. Includes two 4" x 6" front dash standard speakers and two 4" x 6" rear extended range speakers located to rear above door.  | ■<br>—                 | —<br>■             |
| <b>SEATS</b>                            | Scotchgard™ Protection on all cloth seats and cloth door panels.<br>Regular Cab: Front 3-passenger bench with head restraints and folding backrest.<br>Extended Cab: Front reclining 3-passenger 40/60 split bench with head restraints and folding rear bench seat.<br>Crew Cab: Front 3-passenger bench with head restraints and folding backrest and rear 3-passenger bench with folding backrest. | ■<br>■<br>■<br>■       | ■<br>■<br>■<br>■   |
| <b>STEERING WHEEL</b>                   | Custom urethane 4-spoke.<br>Sport urethane 4-spoke.   | ■<br>—                 | —<br>■             |
| <b>STORAGE TRAY</b>                     | Full width behind seat on floor.  | —                      | ■                  |
| <b>SUNSHADE</b>                         | Color-keyed cloth RH and LH, padded.<br>Color-keyed cloth RH and LH, padded with cloth covering, storage strap on LH unit and visor mirror on RH unit.<br>Crew Cab: Padded, color-keyed RH and LH sunshades with extenders and illuminated mirrors. LH sunshade has storage strap.  | ■<br>—<br>—            | —<br>■<br>■        |
| <b>TOOLS</b>                            | Mechanical jack and wheel wrench located behind front seat or on rear compartment floor.  | ■                      | ■                  |
| <b>TRIM PANELS</b>                      | Extended Cabs have rear, upper, lower and side trim panels and a molded color-keyed, cloth headliner with matching retaining moldings.  | ■                      | ■                  |
| <b>WINDOWS</b>                          | Solar-Ray tinted glass.   | ■                      | ■                  |
| <b>WINDSHIELD WIPERS</b>                | Intermittent.   | ■                      | ■                  |



# C/K PICKUP

## POWERTRAINS

Chevrolet offers a variety of engines, transmissions and rear axle ratios for the C/K Pickups. The following charts detail basic engine, transmission and axle specifications. See your 1993 Chevrolet Truck Order Guide for details.

| ENGINES   |                          |                       |                       |                          |                       |                    |                       |                              |                              |                              |
|---|--------------------------|-----------------------|-----------------------|--------------------------|-----------------------|--------------------|-----------------------|------------------------------|------------------------------|------------------------------|
| ENGINE  | 4.3L V6                  | 4.3L V6 HD            | 5.0L V8               | 5.7L V8                  | 5.7L V8 HD            | 7.4L V8            | 7.4L V8 HD            | 6.2L V8 DIESEL               | 6.2L V8 DIESEL HD            | 6.5L V8 TURBO DIESEL         |
| Order Code Restrictions                           | LB4<br>8500 GVW or Under | LB4<br>Above 8500 GVW | L03<br>Up To 7200 GVW | L05<br>8500 GVW or Under | L05<br>Above 8500 GVW | L19<br>454 SS Only | L19<br>Above 8500 GVW | LH6<br>8500 GVW or Under     | LL4<br>Above 8500 GVW        | L65<br>Above 8500 GVW        |
| SAE Net Horsepower<br>Horsepower @ RPM            | 165@<br>4000             | 155@<br>4000          | 175@<br>4000          | 210@<br>4000             | 190@<br>4000          | 255@<br>4000       | 230@<br>3600          | 140@<br>3600                 | 150@<br>3500                 | 190@<br>3400                 |
| SAE Net Torque<br>Lb. Ft. @ RPM                   | 235@<br>2000             | 230@<br>2400          | 270@<br>2400          | 300@<br>2800             | 300@<br>2400          | 405@<br>2400       | 385@<br>1600          | 255@<br>1900                 | 280@<br>2000                 | 380@<br>1700                 |
| Fuel System                                       | EFI                      | EFI                   | EFI                   | EFI                      | EFI                   | EFI                | EFI                   | Gear Driven<br>Mechanical FI | Gear Driven<br>Mechanical FI | Gear Driven<br>Mechanical FI |
| Clutch Size (in.)                                 | 11                       | 11                    | 12                    | 12                       | 12                    | -                  | 12                    | 12                           | 12                           | 12                           |
| Standard Battery<br>Cold Cranking<br>Amps @ 0°F   | 630                      | 630                   | 630                   | 630                      | 630                   | 630                | 630                   | 2 @ 570 each                 | 2 @ 570 each                 | 2 @ 570 each                 |
| Standard Alternator<br>Maximum Capacity<br>(Amps) | 100                      | 100                   | 100                   | 100                      | 100                   | 100                | 100                   | 100                          | 100                          | 100                          |

| TRANSMISSIONS              |  |   |  |  |
|----------------------------|--|---|--|--|
|                            | MANUAL   |   | AUTOMATIC  |  |
|                            | MANUAL 5-SPEED<br>W/OVERDRIVE<br>(HM290) (MG5) | MANUAL 5-SPEED<br>W/OVERDRIVE<br>AND DEEP LOW<br>HEAVY-DUTY<br>(NP4500) | ELECTRONIC<br>AUTOMATIC 4-SPEED<br>OVERDRIVE W/TORQUE<br>CONVERTER CLUTCH<br>(4L60-E)(M30) | ELECTRONICALLY-<br>CONTROLLED<br>AUTOMATIC 4-SPEED<br>W/OVERDRIVE<br>HEAVY-DUTY<br>(4L80-E)(MT1) |
| Transmission<br>Order Code | MM5  | MT8   | MX0  | MX0  |
| Application                | 8500 GVW or Under                              | See Order Guide   | 8500 GVW or Under  | Above 8500 GVW<br>and 454SS (B4U)  |
| Synchronized<br>Speeds     | * 2/3/4/5                                      | 1/2/3/4/5   | —  | —  |
| Gear Ratios                |  |   |  |  |
| First                      | 4.02   | 6.34  | 3.06   | 2.48   |
| Second                     | 2.32   | 3.44  | 1.63   | 1.48   |
| Third                      | 1.40   | 1.71  | 1.00   | 1.00   |
| Fourth                     | 1.00   | 1.00  | 0.70   | 0.75   |
| Fifth                      | 0.73   | 0.73  | -  | -  |
| Reverse                    | 3.74   | 6.34  | 2.29   | 2.08   |
| Power Take Off             | No   | Yes   | No   | No   |

| REAR AXLES                   |                           |      |      |      |                           |      |      |      |                           |      |      |      |                           |      |      |      |                               |      |      |      |                           |      |      |      |      |
|------------------------------|---------------------------|------|------|------|---------------------------|------|------|------|---------------------------|------|------|------|---------------------------|------|------|------|-------------------------------|------|------|------|---------------------------|------|------|------|------|
| Availability                 | (See Order Guide)         |      |      |      | (See Order Guide)         |      |      |      | (See Order Guide)         |      |      |      | (See Order Guide)         |      |      |      | (See Order Guide)             |      |      |      |                           |      |      |      |      |
| Make/Capacity (lbs.)         | GM/<br>3404 Semi-Floating |      |      |      | GM/<br>3750 Semi-Floating |      |      |      | GM/<br>4800 Semi-Floating |      |      |      | GM/<br>6000 Full-Floating |      |      |      | GM/6000-6084<br>Full-Floating |      |      |      | GM/<br>7500 Full-Floating |      |      |      |      |
| Pinion and Ring<br>Gear Type | Hypoid                    |      |      |      | Hypoid                    |      |      |      | Hypoid                    |      |      |      | Hypoid                    |      |      |      | Hypoid                        |      |      |      | Hypoid                    |      |      |      |      |
| Axle Ratio Code              | GU4                       | GU6  | GT4  | GT5  | GU4                       | GU6  | GT4  | GT5  | GU6                       | GT4  | GT5  | GU6  | GT4                       | GT5  | HC4  | GU6  | GT4                           | GT5  | HC4  | GT4  | GT5                       | HC4  | GT4  | GT5  | HC4  |
| Ratio                        | 3.08                      | 3.42 | 3.73 | 4.10 | 3.08                      | 3.42 | 3.73 | 4.10 | 3.42                      | 3.73 | 4.10 | 3.42 | 3.73                      | 4.10 | 4.56 | 3.42 | 3.73                          | 4.10 | 4.56 | 3.73 | 4.10                      | 4.56 | 3.73 | 4.10 | 4.56 |
| Pinion Teeth                 | 13                        | 12   | 11   | 10   | 13                        | 12   | 11   | 10   | 12                        | 11   | 10   | 12   | 11                        | 10   | 9    | 12   | 11                            | 10   | 9    | 10   | 9                         | 11   | 10   | 9    | 9    |
| Ring Gear Teeth              | 41                        | 41   | 41   | 41   | 41                        | 41   | 41   | 41   | 41                        | 41   | 41   | 41   | 41                        | 41   | 41   | 41   | 41                            | 41   | 41   | 41   | 41                        | 41   | 41   | 41   | 41   |
| Ring Gear Diameter (in.)     | 8.5                       | 8.5  | 8.5  | 8.5  | 8.5                       | 8.5  | 8.5  | 8.5  | 9.5                       | 9.5  | 9.5  | 9.5  | 9.5                       | 9.5  | 9.5  | 10.5 | 10.5                          | 10.5 | 10.5 | 10.5 | 10.5                      | 10.5 | 10.5 | 10.5 | 10.5 |

Note: Axle Ratio availability depends on model, powertrain and emissions selected. See your 1993 Chevrolet Truck Order Guide for specific details.

| FRONT AXLES                  |                           |  |      |  |                         |  |      |  |                         |  |      |  |
|------------------------------|---------------------------|--|------|--|-------------------------|--|------|--|-------------------------|--|------|--|
| Availability                 | K1500 & K2500 w/7200 GVWR |  |      |  | K2500 w/C6P & K3500     |  |      |  | K30943                  |  |      |  |
| Make/Capacity (lbs.)         | GM/3925                   |  |      |  | GM/4250                 |  |      |  | GM/4500                 |  |      |  |
| Pinion and Ring<br>Gear Type | Hypoid                    |  |      |  | Hypoid                  |  |      |  | Hypoid                  |  |      |  |
| Ratio                        | 3.42                      |  | 3.73 |  | 4.10                    |  | 4.56 |  | 4.10                    |  | 4.56 |  |
| Pinion Teeth                 | 12                        |  | 11   |  | 10                      |  | 9    |  | 10                      |  | 9    |  |
| Ring Gear Teeth              | 41                        |  | 41   |  | 41                      |  | 41   |  | 41                      |  | 41   |  |
| Ring Gear Diameter (in.)     | 8.25                      |  | 8.25 |  | 8.25                    |  | 9.25 |  | 9.25                    |  | 9.75 |  |
| Differential Type            | 2-Pinion Tapered Roller   |  |      |  | 2-Pinion Tapered Roller |  |      |  | 2-Pinion Tapered Roller |  |      |  |
| Bearings, Type               |                           |  |      |  |                         |  |      |  |                         |  |      |  |
| Lubricant Capacity (pints)   | 4.5                       |  |      |  | 6                       |  |      |  | 6                       |  |      |  |

Note: Axle Ratio availability depends on model, powertrain and emissions selected. See your 1993 Chevrolet Truck Order Guide for specific details.

## TRIM LEVELS

Chevrolet offers C/K Pickups in two primary trim levels — “Cheyenne” and “Silverado.” The following chart details major standard features. See your 1993 Chevrolet Truck Order Guide for more details, including information on the WT 1500, Sport Pickup and 454SS.

| CHASSIS EQUIPMENT                          |   | CHEYENNE<br>(STANDARD) | SILVERADO<br>(YE9) |
|--|---|------------------------|--------------------|
| <b>KEY:</b> ■ = STANDARD, — = NOT INCLUDED |   |                        |                    |
| <b>BRAKES</b>                              | Power assisted; front disc, rear drum. Self-adjusting. Includes rear-wheel anti-lock system that operates in 2-wheel drive only.  | ■                      | ■                  |
| <b>EXHAUST</b>                             | Single.   | ■                      | ■                  |
| <b>FRAME</b>                               | All-welded ladder-type, channel design and boxed front-end section. Section modulus (cu. in.): Reg. Cabs — 2.66 on C/K 1500 and C/K 2500 (2WD); 3.27 on C/K 1500 and C/K 2500 (4WD); 5.26 on C/K 2500/C6P and C/K3500 (2WD); 5.25 on C/K2500 w/C6P and C/K3500 (4WD). ext. Cabs — 3.37 on C/K1500 and C/K2500 (2WD); 4.06 on C/K 1500 and C/K2500 (4WD); 6.06 on C/K 2500 w/C6P and C/K3500. Crew Cab — 7.49 on all models. | ■                      | ■                  |
| <b>FUEL TANK</b>                           | 25.0 gallon (approx.) capacity on C/K 10703/53 and C/K 20753 models.<br>34.0 gallon (approx.) capacity on all other models.   | ■                      | ■                  |
| <b>REAR AXLE</b>                           | Hypoid semi-floating on C/K 1500 and 2500. Full-floating on C/K 2500/C6P w/L19 or L65 and C/K3500.  | ■                      | ■                  |

# C/K PICKUP

| SERIES                           | MODEL NUMBER/<br>BODY CODE/<br>OPTION CODE | PASSENGER CAPACITY<br>(STD./OPT.) | STANDARD ENGINE/<br>TRANS. | OPTIONAL ENGINE/<br>TRANS.   | GVWR<br>(LBS.) | GAWR<br>(LBS.)<br>FRONT/<br>REAR | MAXIMUM PAYLOAD<br>(LBS.)<br>BASED ON<br>CURB WT. | MAX. GROSS TRAILER WT./<br>TONGUE LOAD (LBS.)<br>PROPERLY EQUIPPED |
|----------------------------------|--|-----------------------------------|----------------------------|--|----------------|----------------------------------|---|--|
| <b>FOUR-WHEEL DRIVE MODELS</b>   |  |                                   |                            |  |                |                                  |   |  |
| <b>K1500 REGULAR CAB</b>         |  |                                   |                            |  |                |                                  |   |  |
| <b>SPORTSIDE SHORT BOX</b>       | CK10703/E62                                | 3/2                               | 4.3L V6/M5                 | 4.3L V6/A4<br>5.0L V8/M5/A4<br>5.7L V8/M5/A4                                   | 6100           | 3600/3750                        | 1957  | 5000/600<br>6500/780<br>7000/840                                   |
| <b>FLEETSIDE SHORT BOX</b>       | CK10703/E63                                | 3/2                               | 4.3L V6/M5                 | 4.3L V6/A4<br>5.0L V8/M5/A4<br>5.7L V8/M5/A4                                   | 6100           | 3600/3750                        | 1957  | 5000/600<br>6500/780<br>7000/840                                   |
| <b>FLEETSIDE LONG BOX WT1500</b> | CK10903/E63/<br>VLA                        | 3/-                               | 4.3L V6/M5                 | 4.3L V6/A4   | 6100           | 3600/3750                        | 1828  | 5000/600   |
| <b>FLEETSIDE LONG BOX</b>        | CK10903/E63                                | 3/2                               | 4.3L V6/M5                 | 4.3L V6/A4<br>5.0L V8/M5/A4<br>5.7L V8/M5/A4<br>6.2L V8/M5/A4                  | 6100           | 3600/3750                        | 1828  | 5000/600<br>6500/780<br>7000/840<br>5500/660                       |
| <b>K1500 EXTENDED CAB</b>        |  |                                   |                            |  |                |                                  |   |  |
| <b>SPORTSIDE SHORT BOX</b>       | CK10753/E62                                | 6/5/3                             | 4.3L V6/M5                 | 4.3L V6/A4<br>5.0L V8/M5/A4<br>5.7L V8/M5/A4                                   | 6200           | 3600/3750                        | 1758  | 5000/600<br>6500/780<br>7000/840                                   |
| <b>SPORTSIDE SHORT BOX HD</b>    | CK10753/E62/<br>F44                        | 6/5/3                             | 4.3L V6/M5                 | 4.3L V6/A4<br>5.0L V8/M5/A4<br>5.7L V8/M5/A4<br>6.2L V8/M5/A4                  | 6600           | 3600/4800                        | 2082  | 5000/600<br>6500/780<br>7000/840<br>5500/660                       |
| <b>FLEETSIDE SHORT BOX</b>       | CK10753/E63                                | 6/5/3                             | 4.3L V6/M5                 | 4.3L V6/A4<br>5.0L V8/M5/A4<br>5.7L V8/M5/A4                                   | 6200           | 3600/3750                        | 1758  | 5000/600<br>6500/780<br>7000/840                                   |
| <b>FLEETSIDE SHORT BOX HD</b>    | CK10753/E63/<br>F44                        | 6/5/3                             | 4.3L V6/M5                 | 4.3L V6/A4<br>5.0L V8/M5/A4<br>5.7L V8/M5/A4<br>6.2L V8/M5/A4                  | 6600           | 3600/4800                        | 2082  | 5000/600<br>6500/780<br>7000/840<br>5500/660                       |
| <b>FLEETSIDE LONG BOX</b>        | CK10953/E63                                | 6/5/3                             | 4.3L V6/M5                 | 4.3L V6/A4<br>5.0L V8/M5/A4<br>5.7L V8/M5/A4                                   | 6200           | 3600/3750                        | 1530  | 5000/600<br>6500/780<br>7000/840                                   |
| <b>FLEETSIDE LONG BOX HD</b>     | CK10953/E63/<br>F44                        | 6/5/3                             | 4.3L V6/M5                 | 4.3L V6/A4<br>5.0L V8/M5/A4<br>5.7L V8/M5/A4<br>6.2L V8/M5/A4                  | 6600           | 3600/4800                        | 1854  | 5000/600<br>6500/780<br>7000/840<br>5500/660                       |
| <b>K2500 REGULAR CAB</b>         |  |                                   |                            |  |                |                                  |   |  |
| <b>FLEETSIDE LONG BOX</b>        | CK20903/E63                                | 3/2                               | 4.3L V6/M5                 | 4.3L V6/A4<br>5.0L V8/M5/A4<br>5.7L V8/M5/A4<br>6.2L V8/M5/A4                  | 7200           | 3750/4670                        | 2794  | 5500/660<br>7500/900<br>8500/840<br>5500/660                       |
| <b>FLEETSIDE LONG BOX HD</b>     | CK20903/E63/<br>C6P<br>YHH or YGK          | 3/2                               | 4.3L V6/M5                 | 4.3L V6/A4<br>5.7L V8/M5/A4<br>7.4L V8/M5/A4<br>6.2L V8/M5/A4<br>6.5L V8/M5/A4 | 8600           | 3750/6000                        | 3811  | 6000/720<br>10000/1000<br>10000/1000<br>8000/960<br>9000/1000      |

See the following page for 4-Wheel Drive Models.

| SERIES                                     | MODEL NUMBER/<br>BODY CODE/<br>OPTION CODE | PASSENGER CAPACITY<br>(STD./OPT.) | STANDARD ENGINE/<br>TRANS. | OPTIONAL ENGINE/<br>TRANS.   | GVWR<br>(LBS.) | GAWR<br>(LBS.)<br>FRONT/<br>REAR | MAXIMUM PAYLOAD<br>(LBS.)<br>BASED ON<br>CURB WT. | MAX. GROSS TRAILER WT./<br>TONGUE LOAD (LBS.)<br>PROPERLY EQUIPPED |
|--|--|-----------------------------------|----------------------------|--|----------------|----------------------------------|---|--|
| <b>FOUR-WHEEL DRIVE MODELS (CONT.)</b>     |  |                                   |                            |  |                |                                  |   |  |
| <b>K2500 EXTENDED CAB</b>                  |  |                                   |                            |  |                |                                  |   |  |
| <b>FLEETSIDE SHORT BOX</b>                 | CK20753/E63                                | 6/5/3                             | 4.3L V6/M5                 | 4.3L V6/A4<br>5.0L V8/M5/A4<br>5.7L V8/M5/A4<br>6.2L V8/M5/A4                  | 7200           | 3750/4410                        | 2663  | 5500/660<br>7500/900<br>8500/1000<br>6500/780                      |
| <b>FLEETSIDE LONG BOX</b>                  | CK20953/E63                                | 6/5/3                             | 4.3L V6/M5                 | 4.3L V6/A4<br>5.0L V8/M5/A4<br>5.7L V8/M5/A4<br>6.2L V8/M5/A4                  | 7200           | 3750/4410                        | 2511  | 6000/720<br>7500/900<br>8500/1000<br>6500/780                      |
| <b>FLEETSIDE LONG BOX HD</b>               | CK20953/E63/<br>C6P<br>YGK or YHH          | 6/5/3                             | 4.3L V6/M5                 | 4.3L V6/A4<br>5.7L V8/M5/A4<br>7.4L V8/M5/A4<br>6.2L V8/M5/A4<br>6.5L V8/M5/A4 | 8600           | 3750/6000                        | 3514  | 6000/720<br>10000/1000<br>10000/1000<br>8000/960<br>9000/1000      |
| <b>K3500 REGULAR CAB</b>                   |  |                                   |                            |  |                |                                  |   |  |
| <b>FLEETSIDE LONG BOX</b>                  | CK30903/E63<br>YGK or YHH                  | 3/2                               | 5.7L V8/M5                 | 5.7L V8/A4<br>7.4L V8/M5/A4<br>6.2L V8/M5/A4<br>6.5L V8/M5/A4                  | 9200           | 3750/6084                        | 4151  | 9000/1000<br>10000/1000<br>7500/900<br>8500/1000                   |
| <b>FLEETSIDE LONG BOX DUAL REAR WHEELS</b> | CK30903/E63/<br>R05                        | 3/2                               | 5.7L V8/M5                 | 5.7L V8/A4<br>7.4L V8/M5/A4<br>6.2L V8/M5/A4<br>6.5L V8/M5/A4                  | 10000          | 3750/7500                        | 4670  | 9000/1000<br>10000/1000<br>7500/900<br>8500/1000                   |
| <b>K3500 EXTENDED CAB</b>                  |  |                                   |                            |  |                |                                  |   |  |
| <b>FLEETSIDE LONG BOX</b>                  | CK30953/E63<br>YGK or YHH                  | 6/5/3                             | 5.7L V8/M5                 | 5.7L V8/A4<br>7.4L V8/M5/A4<br>6.2L V8/M5/A4<br>6.5L V8/M5/A4                  | 9200           | 3750/6084                        | 3876  | 9000/1000<br>10000/1000<br>7500/900<br>8500/1000                   |
| <b>FLEETSIDE LONG BOX DUAL REAR WHEELS</b> | CK30953/E63/<br>R05                        | 6/5/3                             | 5.7L V8/M5                 | 5.7L V8/A4<br>7.4L V8/M5/A4<br>6.2L V8/M5/A4<br>6.5L V8/M5/A4                  | 10000          | 3750/7500                        | 4394  | 9000/1000<br>10000/1000<br>7500/900<br>8500/1000                   |
| <b>K3500 CREW CAB</b>                      |  |                                   |                            |  |                |                                  |   |  |
| <b>SINGLE REAR WHEELS</b>                  | CK30943/E63                                | 6/5                               | 5.7L V8/M5                 | 5.7L V8/A4<br>7.4L V8/M5/A4<br>6.5L V8/M5/A4                                   | 9200           | 4500/6084                        | 3482  | 9000/1000<br>10000/1000<br>8500/1000                               |
| <b>DUAL REAR WHEELS</b>                    | CK30943/E63/<br>R05                        | 6/5                               | 5.7L V8/M5                 | 5.7L V8/A4<br>7.4L V8/M5/A4<br>6.5L V8/M5/A4                                   | 10000          | 4500/7500                        | 4004  | 9000/1000<br>10000/1000<br>8500/1000                               |

# C/K PICKUP

## MODEL SELECTION SUMMARY

Use the chart below to choose the model that fits your needs. Note that the Maximum Payload is based on curb weight. Also, the Maximum Gross Trailer Weight is based on vehicles that are properly equipped. See your 1993 Chevrolet Truck Order Guide for details.

| SERIES                                    | MODEL NUMBER/<br>BODY CODE/<br>OPTION CODE              | PASSENGER<br>CAPACITY<br>(STD./OPT.) | STANDARD<br>ENGINE/<br>TRANS. | OPTIONAL<br>ENGINE/<br>TRANS.  | GVWR<br>(LBS.) | GAWR<br>(LBS.)<br>FRONT/<br>REAR | MAXIMUM<br>PAYLOAD<br>(LBS.)<br>BASED ON<br>CURB WT. | MAX. GROSS<br>TRAILER WT./<br>TONGUE<br>LOAD (LBS.)<br>PROPERLY<br>EQUIPPED |
|---|---|--------------------------------------|-------------------------------|--|----------------|----------------------------------|--|---|
| <b>TWO-WHEEL DRIVE MODELS</b>             |   |                                      |                               |  |                |                                  |  |   |
| <b>C1500 REGULAR CAB</b>                  |   |                                      |                               |  |                |                                  |  |   |
| <b>SPORTSIDE<br/>SHORT BOX</b>            | CC10703/E62   | 3/2                                  | 4.3L V6/M5                    | 4.3L V6/A4<br>5.0L V8/M5/A4<br>5.7L V8/M5/A4                                   | 5600           | 2950/3404                        | 1871   | 5000/600<br>6000/720<br>7500/900  |
| <b>FLEETSIDE<br/>SHORT BOX</b>            | CC10703/E63   | 3/2                                  | 4.3L V6/M5                    | 4.3L V6/A4<br>5.0L V8/M5/A4<br>5.7L V8/M5/A4                                   | 5600           | 2950/3404                        | 1894   | 5000/600<br>6000/720<br>7500/900  |
| <b>FLEETSIDE<br/>454 SS<br/>SHORT BOX</b> | CC10703/E63/<br>B4U                                     | 2/-                                  | 7.4L V8/A4                    | —  | 5600           | 3150/3404                        | 1292   | 6000/720  |
| <b>FLEETSIDE<br/>LONG BOX<br/>WT1500</b>  | CC10903/E63/<br>VLA/YET<br>CC10903/E63/<br>VLA/YFL      | 3/-<br>3/-                           | 4.3L V6/M5<br>4.3L V6/M5      | 4.3L V6/A4<br>4.3L V6/A4   | 5600<br>6100   | 2950/3404<br>3150/3686           | 1747<br>2231   | 5000/600<br>5000/600  |
| <b>FLEETSIDE<br/>LONG BOX</b>             | CC10903/E63/<br>YET or YEV                              | 3/2                                  | 4.3L V6/M5                    | 4.3L V6/A4<br>5.0L V8/M5/A4<br>5.7L V8/M5/A4                                   | 5600           | 2950/3404                        | 1747   | 5000/600<br>6000/720<br>7500/900  |
| <b>FLEETSIDE<br/>LONG BOX<br/>HD</b>      | CC10903/E63<br>(Reqs. YFL,<br>YFM, YFN<br>or YCN tires) | 3/2                                  | 4.3L V6/M5                    | 4.3L V6/A4<br>5.0L V8/M5/A4<br>5.7L V8/M5/A4<br>6.2L V8/M5/A4                  | 6100           | 3150/3686                        | 2231   | 5000/600<br>6000/720<br>7500/900<br>5000/600                                |
| <b>C1500 EXTENDED CAB</b>                 |   |                                      |                               |  |                |                                  |  |   |
| <b>SPORTSIDE<br/>SHORT BOX</b>            | CC10753/E62   | 6/5/3                                | 4.3L V6/M5                    | 4.3L V6/A4<br>5.0L V8/M5/A4<br>5.7L V8/M5/A4<br>6.2L V8/M5/A4                  | 6200           | 3500/3686                        | 2177   | 5000/600<br>6000/720<br>7500/900<br>5000/600                                |
| <b>FLEETSIDE<br/>SHORT BOX</b>            | CC10753/E63   | 6/5/3                                | 4.3L V6/M5                    | 4.3L V6/A4<br>5.0L V8/M5/A4<br>5.7L V8/M5/A4<br>6.2L V8/M5/A4                  | 6200           | 3500/3686                        | 2200   | 5000/600<br>6000/720<br>7500/900<br>5000/600                                |
| <b>FLEETSIDE<br/>LONG BOX</b>             | CC10953/E63   | 6/5/3                                | 4.3L V6/M5                    | 4.3L V6/A4<br>5.0L V8/M5/A4<br>5.7L V8/M5/A4<br>6.2L V8/M5/A4                  | 6200           | 3500/3686                        | 2051   | 5000/600<br>6000/720<br>7500/900<br>5000/600                                |
| <b>C2500 REGULAR CAB</b>                  |   |                                      |                               |  |                |                                  |  |   |
| <b>FLEETSIDE<br/>LONG BOX</b>             | CC20903/E63   | 3/2                                  | 4.3L V6/M5                    | 4.3L V6/A4<br>5.0L V8/M5/A4<br>5.7L V8/M5/A4<br>6.2L V8/M5/A4                  | 7200<br>7200   | 3150/4670<br>3400/4800           | 3172   | 6000/720<br>8000/960<br>8500/1000<br>6500/780                               |
| <b>FLEETSIDE<br/>LONG BOX<br/>HD</b>      | CC20903/E63/<br>C6P/<br>YHH or YGK                      | 3/2                                  | 4.3L V6/M5                    | 4.3L V6/A4<br>5.7L V8/M5/A4<br>7.4L V8/M5/A4<br>6.2L V8/M5/A4<br>6.5L V8/M5/A4 | 8600           | 3600/6000                        | 4178   | 6500/780<br>10000/1000<br>10000/1000<br>8000/960<br>9500/1000               |

See the following pages for additional 2- and 4- Wheel Drive Models.

| SERIES                                     | MODEL NUMBER/<br>BODY CODE/<br>OPTION CODE | PASSENGER CAPACITY<br>(STD./OPT.) | STANDARD ENGINE/<br>TRANS. | OPTIONAL ENGINE/<br>TRANS.   | GVWR<br>(LBS.) | GAWR<br>(LBS.)<br>FRONT/<br>REAR | MAXIMUM PAYLOAD<br>(LBS.)<br>BASED ON<br>CURB WT. | MAX. GROSS TRAILER WT./<br>TONGUE LOAD (LBS.)<br>PROPERLY EQUIPPED |
|--|--|-----------------------------------|----------------------------|--|----------------|----------------------------------|---|--|
| <b>TWO-WHEEL DRIVE MODELS</b>              |  |                                   |                            |  |                |                                  |   |  |
| <b>C2500 EXTENDED CAB</b>                  |  |                                   |                            |  |                |                                  |   |  |
| <b>FLEETSIDE SHORT BOX</b>                 | CC20753/E63                                | 6/5/3                             | 4.3L V6/M5                 | 4.3L V6/A4<br>5.0L V8/M5/A4<br>5.7L V8/M5/A4<br>6.2L V8/M5/A4                  | 7200           | 3600/4670                        | 3030  | 6000/720<br>8000/960<br>8500/1000<br>5500/660                      |
| <b>FLEETSIDE LONG BOX</b>                  | CC20953/E63                                | 6/5/3                             | 4.3L V6/M5                 | 4.3L V6/A4<br>5.0L V8/M5/A4<br>5.7L V8/M5/A4<br>6.2L V8/M5/A4                  | 7200           | 3600/4670                        | 2897  | 6000/720<br>8000/960<br>8500/1000<br>5500/660                      |
| <b>FLEETSIDE LONG BOX HD</b>               | CC20953/E63/<br>C6P/<br>YHH or YGK         | 6/5/3                             | 4.3L V6/M5                 | 4.3L V6/A4<br>5.7L V8/M5/A4<br>7.4L V8/M5/A4<br>6.2L V8/M5/A4<br>6.5L V8/M5/A4 | 8600           | 3600/6000                        | 3929  | 6500/780<br>10000/1000<br>10000/1000<br>8000/960<br>9500/1000      |
| <b>C3500 REGULAR CAB</b>                   |  |                                   |                            |  |                |                                  |   |  |
| <b>FLEETSIDE LONG BOX</b>                  | CC30903/E63<br>YGK or YHH                  | 3/2                               | 5.7L V8/M5                 | 5.7L V8/A4<br>7.4L V8/M5/A4<br>6.2L V8/M5/A4<br>6.5L V8/M5/A4                  | 9000           | 3600/6084                        | 4324  | 9500/1000<br>10000/1000<br>8000/960<br>9000/1000                   |
| <b>FLEETSIDE LONG BOX DUAL REAR WHEELS</b> | CC30903/E63/<br>R05                        | 3/2                               | 5.7L V8/M5                 | 5.7L V8/A4<br>7.4L V8/M5/A4<br>6.2L V8/M5/A4<br>6.5L V8/M5/A4                  | 10000          | 3600/7500                        | 5053  | 9500/1000<br>10000/1000<br>8000/960<br>9000/1000                   |
| <b>C3500 EXTENDED CAB</b>                  |  |                                   |                            |  |                |                                  |   |  |
| <b>FLEETSIDE LONG BOX</b>                  | CC30953/E63<br>YGK or YHH                  | 6/5/3                             | 5.7L V8/M5                 | 5.7L V8/A4<br>7.4L V8/M5/A4<br>6.2L V8/M5/A4<br>6.5L V8/M5/A4                  | 9000           | 3600/6084                        | 4053  | 9500/1000<br>10000/1000<br>8000/960<br>9000/1000                   |
| <b>FLEETSIDE LONG BOX DUAL REAR WHEELS</b> | CC30953/E63/<br>R05                        | 6/5/3                             | 5.7L V8/M5                 | 5.7L V8/A4<br>7.4L V8/M5/A4<br>6.2L V8/M5/A4<br>6.5L V8/M5/A4                  | 10000          | 3600/7500                        | 4782  | 9500/1000<br>10000/1000<br>8000/960<br>9000/1000                   |
| <b>C3500 CREW CAB</b>                      |  |                                   |                            |  |                |                                  |   |  |
| <b>SINGLE REAR WHEELS</b>                  | CC30943/E63                                | 6/5                               | 5.7L V8/M5                 | 5.7L V8/A4<br>7.4L V8/M5/A4<br>6.5L V8/M5/A4                                   | 9000           | 4100/6084                        | 3671  | 9500/1000<br>10000/1000<br>9000/1000                               |
| <b>SINGLE REAR WHEELS CAMPER SPECIAL</b>   | CC30943/E63/<br>Z81                        | 6/5                               | 5.7L V8/M5                 | 5.7L V8/A4<br>7.4L V8/M5/A4<br>6.5L V8/M5/A4                                   | 9600           | 4100/6084                        | 4221  | 9500/1000<br>10000/1000<br>9000/1000                               |
| <b>DUAL REAR WHEELS</b>                    | CC30943/E63/<br>R05                        | 6/5                               | 5.7L V8/M5                 | 5.7L V8/A4<br>7.4L V8/M5/A4<br>6.5L V8/M5/A4                                   | 10000          | 4100/7500                        | 4401  | 9500/1000<br>10000/1000<br>9000/1000                               |

See the following pages for 4-Wheel Drive Models.