

2731TRUC-94

CHEVROLET

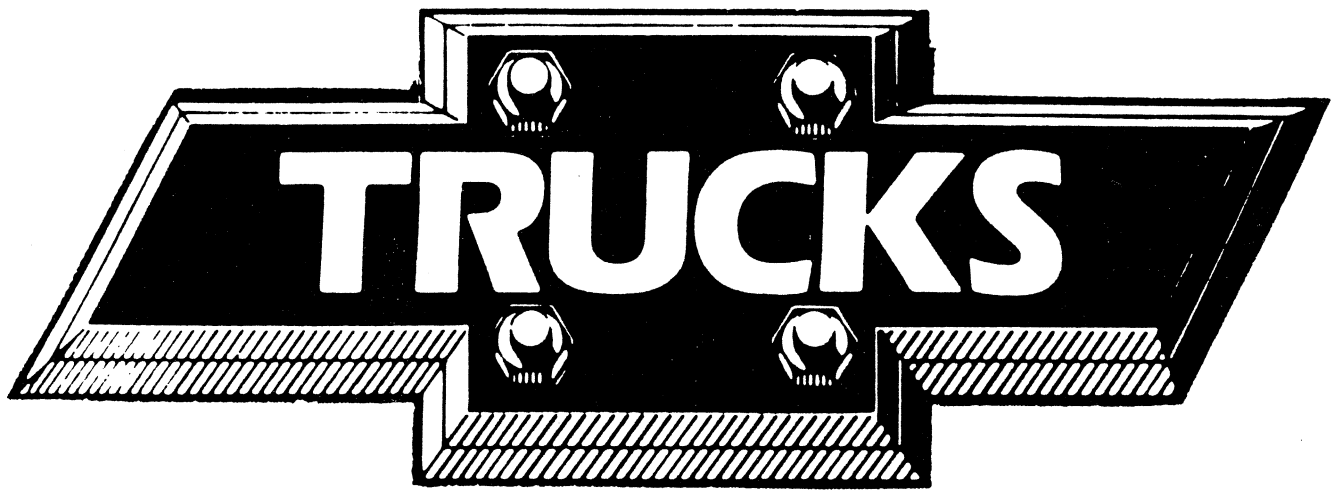

1994

94

C/K Pickup & Crew-Cab

ORDERING INFORMATION

Focus Vehicle—C1500 Regular-Cab Long-Box Pickup with Silverado trim. This vehicle is engineered to out-perform driver expectations. When equipped with PEG 3 (P1A3), this model represents an excellent opportunity for high-volume C/K Pickup sales at your dealership.

Feature Vehicle—K1500 Extended-Cab Short-Box with Silverado trim (detailed on the following sheet).

Performance

■ **4.3 Liter EFI V6 Engine**—provides 165 hp/235 lb.-ft. of torque, towing capacity up to 5,000 lbs. for properly equipped C1500 with this standard engine and balance shaft enhances engine smoothness ■ **Five-Speed Manual Transmission**—overdrive gear is designed to lower engine speed when cruising, contributing to higher fuel efficiency and reduced engine wear ■ **Independent Front Suspension**—pivoted upper and lower control arms reduce deflection, allowing front wheels to travel straight up and down. Keeps tires in firm contact with the road providing smooth, stable ride and good directional control

Options

■ **Choice of Engines**—the C/K lineup includes six powerplants for widely varying needs...from the fuel-efficient 4.3 Liter V6 all the way up to the workhorse 7.4 Liter V8 which can tow up to 13,000 lbs. in a properly equipped C3500 Crew-Cab ■ **Manual and Automatic Transmissions**—optional four-speed electronically controlled automatic transmission offers a smooth shifting alternative ■ **Extra Protection**—outfit C/K for a multitude of work and recreational activities with options like a full bedliner which protects cargo bed, sidewalls, inside tailgate panel, and provides insulation from road noise

Work Credentials

■ **Steel Ladder-Type Frame with Drop Center Design**—reduced step-in height for easy entry/exit, high ground clearance for off-road driving ■ **Double-Wall Cargo Box/Tailgate**—keeps damage on the inside from showing on the outside, helps to keep the truck looking new ■ **Two-Tier Loading**—pockets in upper cargo box wall allow for second loading level above wheel wells for cargo-carrying versatility

Easy

—**TO OWN** ■ **Scotchgard™ Fabric Protector**—on cloth seats, door panels, and carpet, resists stains for easy cleanup ■ **Solar-Ray Tinted Glass**—screens out much of the sun's ultraviolet and infrared rays to help keep interior cool, helps reduce fading and deterioration of interior fabrics/trim

—**ON THE MIND** ■ **Rear-Wheel Anti-Lock Brake System**—reduces rear wheel lockup, contributing to controlled straight line stopping ■ **Center High-Mounted Stop Lamp**—highly visible signal helps prevent rear end collisions (features integral Cargo Lamp) ■ **Roadside Assistance**—24-hour service assistance via Chevrolet's toll-free "800" number. Fast response for towing, repairs, and other services

Reliability/Durability

■ **Base Coat/Clear Coat Paint**—high gloss shine, long-lasting exterior finish resists fading ■ **Anti-Chip Coating**—on lower body surfaces, helps prevent damage to finish ■ **Bumper-to-Bumper Plus Warranty**—3-year/36,000-mile, no-deductible limited warranty, includes parts, labor, 6-year/100,000-mile body sheet metal rust-through protection, 5-year/50,000-mile emissions control system coverage. (Tires covered by their manufacturer.) ■ **Chevrolet Diesel Engine Warranty**—5-year/100,000-mile warranty, \$100 deductible after 3 years/36,000 miles

RED ■ : New Feature
BLACK ■ : Focus Vehicle Feature

FEATURE VEHICLE: K1500 EXTENDED-CAB SHORT-BOX WITH SILVERADO TRIM

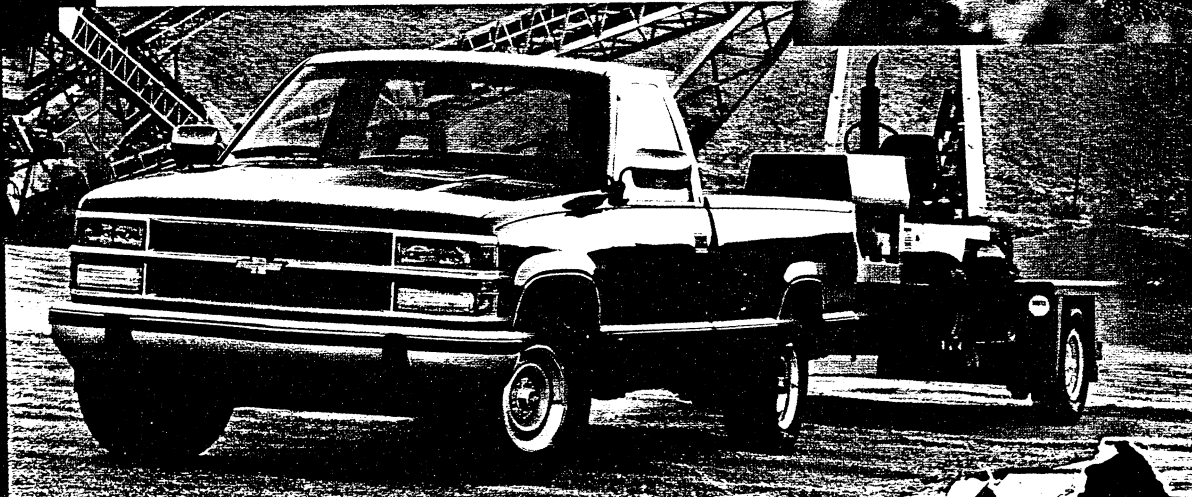

FOCUS VEHICLE:
C1500
REGULAR-CAB
LONG-BOX
PICKUP
WITH
SILVERADO
TRIM

94

C/K Pickup & Crew-Cab

Trim Color/Seat Style Availability

Vinyl available in Beige, Blue, Garnet and Gray

Cloth available in Beige, Blue, Garnet and Gray

Custom Cloth available in Beige, Blue, Garnet and Gray

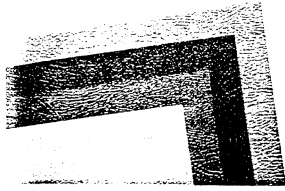

Bench Seat - Cheyenne CK1500

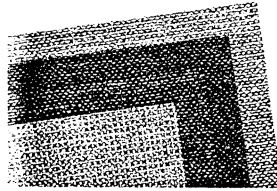

Bench Seat - Cheyenne

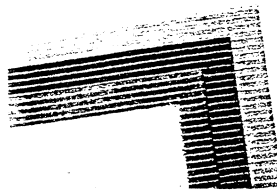

Bench Seat - Silverado CK1500



Reclining Split Bench Seat Cheyenne CK1500

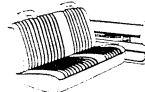

Reclining Split Bench Seat Cheyenne



Reclining Split Bench Seat Silverado



Bench Seat - Silverado

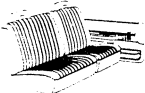

Reclining High-Back Bucket Seats - Silverado



Reclining Split Bench Seat Silverado



Four Most Popular Exterior Colors By Percentage

Below are the anticipated popular C/K Pickup and Crew-Cab colors for 1994 based on national sales volume. They are listed for reference only. To identify the top selling colors in your area, by model, use the Retail Sales Analysis (RSA).

C/K Pickup		Crew-Cab	
Teal Green Metallic	20%	Summit White	39%
Summit White	15%	Victory Red	12%
Indigo Blue Metallic	13%	Onyx Black	11%
Dark Garnet Red	13%	Teal Blue Metallic	9%

Four Most Popular Exterior Colors with Corresponding Interior Color Availability

E X T E R I O R	I N T E R I O R			
	Beige	Blue	Garnet	Gray
Teal Green Metallic	■			■
Summit White	■	■	■	■
Indigo Blue Metallic	■	■		■
Dark Garnet Red	■		■	■
Summit White	■	■	■	■
Victory Red	■		■	■
Onyx Black	■		■	■
Teal Blue Metallic	■			■

NOTE: New C/K Regular-Cab and Extended-Cab Pickup exterior colors are Light Autumnwood Metallic and Dark Autumnwood Metallic. C/K Crew-Cab offers the same two new exterior colors as well as Atlantic Blue Metallic.

Wheels



Standard 15" and 16" steel painted silver with Black hub ornament - W/T1500 - Cheyenne

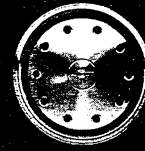

Optional 15" wheel cover - Cheyenne

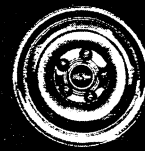

Standard 15" and 16" Rally Wheel trim-standard on Silverado - optional on Cheyenne



Optional chrome-plated wheel with Black hub ornament-(2WD only)*

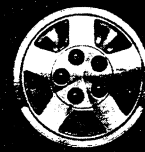

Optional 15" cast-aluminum-C1500 (included with 2WD Sport Pickup)



Optional 16" cast-aluminum-K1500 (included with 4WD Sport Pickup)

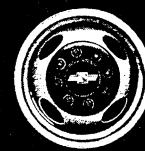

Standard 16" front wheel for Big Doolley

* Included with ZQ8 Sport Handling Package

94

C/K Pickup & Crew-Cab

Forecasted Percent of Mix

REGULAR CAB 50%	C/K 1500	C/K 2500	C/K 3500	EXTENDED CAB 50%	C/K 1500	C/K 2500	C/K 3500	CREW-CAB 100%	C/K 3500
	85%	12%	3%		81%	13%	6%		100%
TOTAL	100%	100%	100%	TOTAL	100%	100%	100%	TOTAL	100%

REGULAR CAB	C/K 1500	C/K 2500	C/K 3500	EXTENDED CAB	C/K 1500	C/K 2500	C/K 3500	CREW-CAB	C/K 3500
LONG WHEELBASE	50%	100%	100%	LONG WHEELBASE	4%	60%	100%	2WD	80%
SHORT WHEELBASE	50%	N/A	N/A	SHORT WHEELBASE	96%	40%	N/A	4WD	20%
TOTAL	100%	100%	100%	TOTAL	100%	100%	100%	TOTAL	100%
SPORTSIDE BOX	17%	N/A	N/A	SPORTSIDE BOX	12%	N/A	N/A	SPORTSIDE BOX	N/A
FLEETSIDE BOX	83%	100%	100%	FLEETSIDE BOX	88%	100%	100%	FLEETSIDE BOX	100%
TOTAL	100%	100%	100%	TOTAL	100%	100%	100%	TOTAL	100%
WORK TRUCK	30%	N/A	N/A	WORK TRUCK	N/A	N/A	N/A	WORK TRUCK	N/A
CHEYENNE	15%	55%	40%	CHEYENNE	4%	10%	10%	CHEYENNE	30%
SILVERADO	55%	45%	60%	SILVERADO	96%	90%	90%	SILVERADO	70%
TOTAL	100%	100%	100%	TOTAL	100%	100%	100%	TOTAL	100%
4-SPEED AUTO	80%	75%	60%	4-SPEED AUTO	85%	80%	70%	4-SPEED AUTO	50%
5-SPEED MANUAL	15%	2%	N/A	5-SPEED MANUAL	10%	1%	0%	5-SPEED MANUAL	N/A
5-SPEED HD MANUAL	5%	23%	40%	5-SPEED HD MANUAL	5%	19%	30%	5-SPEED HD MANUAL	50%
TOTAL	100%	100%	100%	TOTAL	100%	100%	100%	TOTAL	100%
4.3L	40%	2%	N/A	4.3L	15%	1%	N/A	4.3L	N/A
5.0L	10%	3%	N/A	5.0L	5%	1%	N/A	5.0L	N/A
5.7L	45%	70%	35%	5.7L	75%	60%	10%	5.7L	35%
6.5L DIESEL/TURBO-DIESEL	5%	20%	40%	6.5L DIESEL/TURBO-DIESEL	5%	28%	60%	6.5L DIESEL/TURBO-DIESEL	40%
7.4L	N/A	5%	25%	7.4L	N/A	10%	30%	7.4L	25%
TOTAL	100%	100%	100%	TOTAL	100%	100%	100%	TOTAL	100%

Deletions

- The copper-brass radiator has been replaced by a new aluminum radiator on 5.7L, 7.4L gasoline and 6.5L diesel engines. The aluminum design provides additional engine cooling and increased durability.
- The 6.5 Liter Naturally Aspirated V8 Diesel in both Light Duty and Heavy Duty versions replaces the 6.2 Liter V8 Diesel offered in 1993. The new powerplant offers additional power, reliability, and durability.
- Two exterior colors have been dropped for this year: Beige Metallic and Slate Metallic. New exterior colors are Light Autumnwood Metallic and Dark Autumnwood Metallic. C/K Crew-Cab no longer comes in Light Quasar Blue Metallic, Sand Beige Metallic or Slate Metallic, but has added Atlantic Blue Metallic, Light Autumnwood Metallic and Dark Autumnwood Metallic.

Additional Information on Significant Features

- The **Silverado Package** is now available on the **C3500 HD** model. This brings enhanced style and comfort to this hard working member of the Chevy truck family. Uplevel seats and other Silverado interior features like color-keyed carpeting, full-cloth headliner and electronically tuned AM/FM stereo radio make driving this work truck a pleasure.
- The C/K Pickup's **Rear-Wheel Anti-Lock Brakes** reduce chance of rear-wheel lockup, thereby helping to increase steering control and reduce stopping distances on most surfaces. When speed sensors determine rear-wheel speed changes, the Electronic Control Unit activates the anti-lock system which modulates brake fluid pressure to the rear wheels.
- The **4-Speed Electronically Controlled Transmission** is available on the C/K Pickup line. Electronic controls provide consistent, smooth shifts in all weather conditions, regardless of the load. The overdrive gear is designed to reduce engine speed when cruising so less fuel is used, and engine wear reduced.

SILVERADO LT

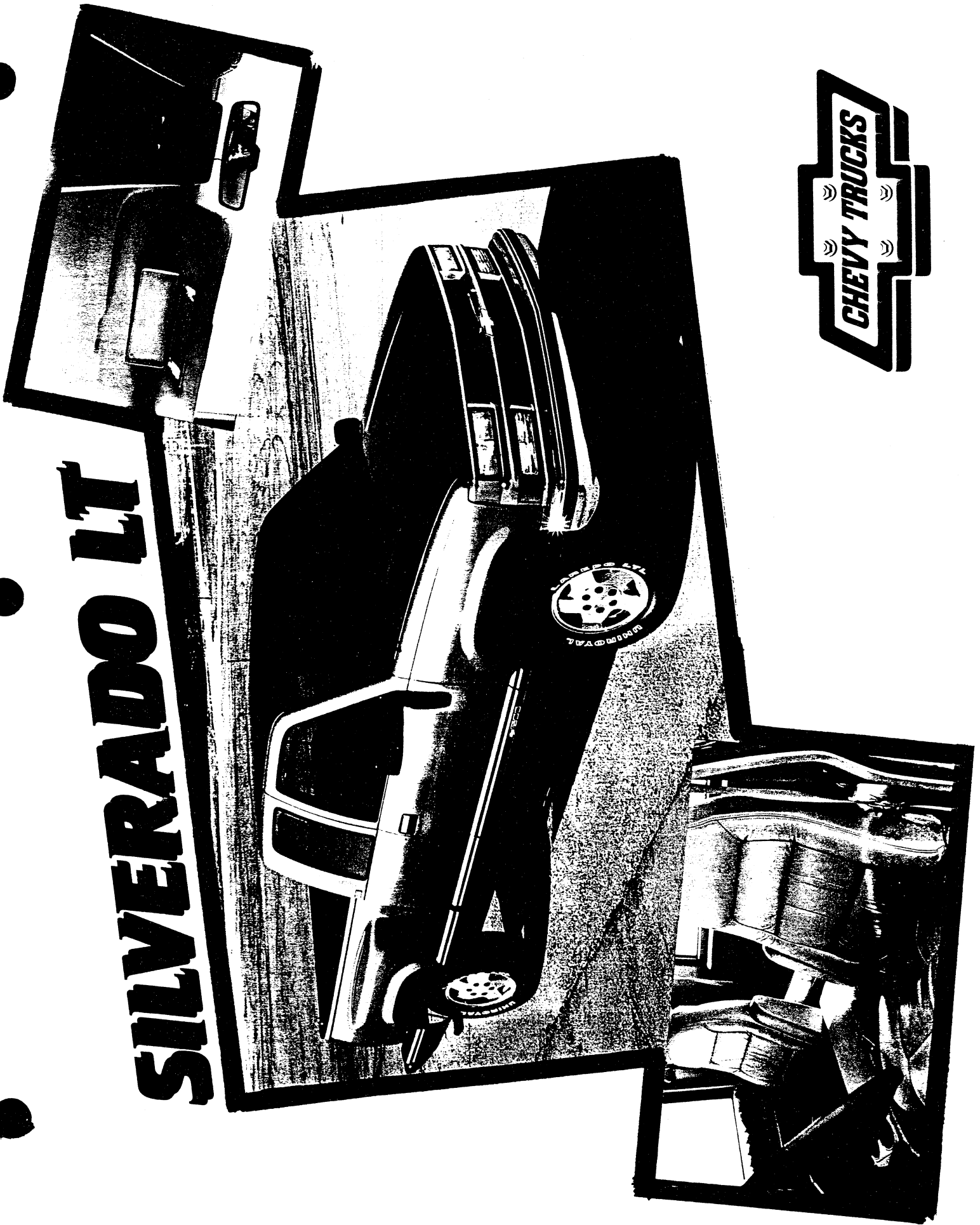

Silverado LT

Eligible Models:

CC10753 & CK10753

Required Options:

		MSRP
PEG	PLT1	\$5614 Less \$700 PEG Savings
Engine	L05	\$845
Transmission	MX0	\$890
Emissions	FE9, NA6, YF5* or NG1	NC
Axle	GU4 or GT4 (4x2)	NC
	GU6 or GT4 (4x4)	NC
Tires	XFL, YFL, ZFL (4x2)	NC
	XBK, YBK, ZBK (4X4)	NC
Interior Trim	AUU6	Incl.
Paint Scheme	ZY1**	NC
Body	E62 or E63	NC

Preferred Equipment Group PLT1 Consists of the Following Equipment:

YE9	Silverado Decor	AG9	Power Driver Seat
C60	Air Conditioning	TR9	Auxiliary Lighting
ZQ2	Convenience Group	ZQ3	Convenience Group
VB3	Rear Chrome Bumper	BZY	Bedliner
U16	Tachometer	N90/PF4	Aluminum Wheels
V27	Bumper Guards	UX1	AM/FM, Cassette w/Equalizer
ZM2	LT Package Which Includes:		
	Beige Leather High Back Bucket Seats		
	Beige Leather Rear Bench Seat		
	Black Break-Away OSRV Mirrors		
	Electrochromic ISRV Mirror w/Compass		
	Exterior Accent Stripe		
	Illuminated Vanity Mirrors		
	Leather Wrapped Steering Wheel		
	Overhead Console		
	Under Dash Cupholders		

* no Black
1992
Socit's color
add chrome
lettering

* no chrome
moldings on
any LT

*YF5 Emissions @ \$100

**Only colors compatible with beige interior are available. Refer to your order guide for colors and compatibility.

Restrictions:

The following are the **only** additional RPO options available with the LT package:

A20	Swing out rear window	R8S	Multiple Orders
AJ1	Deep Tint Glass	A28	Rear Sliding Window
VK3	Front License Plate Bracket	G80	Limited Slip Differential
Z82	Trailer Package	TP2	Auxiliary Battery
V10	Cold Climate Package	C49	Rear Defogger
KNP	Auxiliary Trans Oil Cooler	F51	H.D. Front Shocks
NZZ	Skid Plates	F60	H.D. Front Springs
V08	H.D. Cooling	V76	Tow Hooks
XBX, YBX & ZBX	Tires (4x4)		

Refer to Order Guide for applicable powertrain/option restrictions



MODELS

PASSENGERS

DIMENSIONS (Continued)

REGULAR CAB

Sportside 2-wheel drive (CC10703)	3
Sportside 4-wheel drive (CK10703)	3
Fleetside 2-wheel drive (CC10703)	3
Fleetside 2-wheel drive (CC10903)	3
Fleetside 4-wheel drive (CK10703)	3
Fleetside 4-wheel drive (CK10903)	3

EXTENDED CAB

Sportside 2-wheel drive (CC10753)	6
Sportside 4-wheel drive (CK10753)	6
Fleetside 2-wheel drive (CC10753)	6
Fleetside 2-wheel drive (CC10953)	6
Fleetside 4-wheel drive (CK10753)	6
Fleetside 4-wheel drive (CK10953)	6

DIMENSIONS

Wheelbase (inches)	
CC10703/CK10703	117.5
CC10903/CK10903	131.5
CC10753/CK10753	141.5
CC10953/CK10953	155.5
Cab-Axle (inches)	
CC107*3/CK107*3	41.8
CC109*3/CK109*3	55.9
Length (overall--inches)	
Sportside	
CC10703/CK10703	194.0
CC10753/CK10753	218.0
Fleetside	
CC10703/CK10703	194.1
CC10903/CK10903	212.6
CC10753/CK10753	218.0
CC10953/CK10953	237.0
Width (overall-inches)	
Sportside	77.1
Fleetside	76.8
Box Size	
Length (overall - inches)	
CC107*3/CK107*3	78.7
CC109*3/CK109*3	97.6
Box Depth (inches)	19.3

Payload (pounds)

CC10703	
w/E62	1872
w/E63	1899
CK10703	
w/E62	1935
w/E63	1968
CC10903	
w/o Diesel Engine	1762
w/Diesel Engine	1741
CK10903	
w/o Diesel Engine	1817
w/Diesel Engine	1440
CC10753	
w/E62	2200
w/E63	2315
CK10753	
w/E62	1740
w/E63	1742
CC10953	1975
CK10953	1595
GVWR	
CC10*03	5600
C-K10*03	6100
CK10*53	6200.
Fuel Tank Capacity	
C-K107*3	25 Gal.
C-K109*3	34 Gal.

POWER TEAMS**Standard Engine**

RPO LB4 4.3 Liter (262 Cu In) V6 with Electronic Fuel Injection (EFI) without C-K10953

Standard Transmission

RPO MM5 5-speed manual

RPO L03 5.0 Liter (305 Cu In) V8 with Electronic Fuel Injection (EFI) with C-K10903

STANDARD EQUIPMENT SUMMARY**EXTERIOR****Air Dam:**

Without X81 Work Package, Black

With X81 Work Package, Dark Argent

Brakes: Power assisted front disc, rear drum. Rear wheel anti-lock

Bumper: Chromed front without X81 Work Truck and Argent with X81 Work Truck

Grille: Molded painted argent

Headlamps: Single rectangular halogen

Mirrors: RH and LH below-eye-line, painted black

Nameplate: Cheyenne: w/o X81 Work Truck Pkg

Spare Tire/Wheel: Full-size spare tire and wheel w/o X81 Work Truck Pkg

Spare Tire Carrier: Winch-type spare tire carrier mounted under the frame at the rear

Stop Lamp: Center Mounted with Cargo Lamp

Tires:

CC10703/CC10903--P225/75R15 All Seasons Steel

Belted Radial Ply BW

CK10703/CK10903--LT225/75R16C All Seasons Steel

Belted Radial Ply BW

CC10753/CC10953--P235/75R15 All Seasons Steel

Belted Radial Ply BW

CK10753/CK10953--LT245/75R16C All Seasons Steel

Belted Radial Ply BW

Tow Hooks: Two front tow hooks on 4-wheel drive models

Wheels: Silver painted steel with black hub ornament

Windshield Wipers: Intermittent

INTERIOR

Cigarette Lighter

Cupholders, Mounted Under Dash with Bench or 60/40

Seat(s). Located in Center Console with Bucket Seats

Dome Lamp: With switch in LH and RH door jamb

Door Guard Beams: Side

Floor Covering: Rubber mat

Without X81 Work Package, Color-keyed

With X81 Work Package, Embossed Black

Gages: Engine temperature, fuel level, odometer, oil pressure, speedometer, telltale lights, trip odometer and voltmeter

Glass: Tinted, Solar-Ray, all windows

Glove Box: Latched door and beverage holder

Headliner: Color-Keyed

w/o X81 Work Pkg, Cloth with Matching retainer moldings

w/X81 Work Pkg, Vinyl

Heater: Deluxe heater with windshield and side window defoggers

INTERIOR (Continued)

Mirror: Rearview

Radiator, Heavy-Duty

Radio: Electronically-tuned AM radio with fixed mast antenna (w/o X81 Work Package)

Scotchgard Fabric Protector on Cloth Trim and Door Panels (w/o X81 Work Package)

Seats:

Regular Cab: 3-Passenger all vinyl trim front bench seat with folding backrest

Extended Cab: 60/40 Cloth Split Bench includes folding rear seat

Optional Bucket Seats include Console

Steering Wheel: Custom urethane 4-spoke

Sunshades: Color-keyed cloth RH and LH padded

OPTIONAL UPLEVEL DECOR SILVERADO DECOR LEVEL (RPO YE9)

The following equipment is in addition to or replacing items included in the Cheyenne decor

EXTERIOR

Bumper: Chrome front bumper includes a black rub strip with bright trim

Grille: Deluxe front appearance package with dark argent grille and bright trim

Headlamps: Dual composite halogen

Horn: Dual low and high note electric

Moldings: Black body side moldings with bright trim.

Fleetside includes bright wheel opening moldings

Nameplate: Silverado

Wheels: Rally wheel trim

Windows: Rear Quarter Swing-out (C-K10*53 only)

INTERIOR

Floor Covering: Color-keyed carpeting

Floor Mats: Front removable color-keyed rubber. Extended Cab includes rear mat

Radio: Electronically tuned AM/FM stereo w/seek-scan and digital clock

Seats:

Regular Cab: 3-passenger with choice of vinyl or custom cloth front bench seat with head restraint and folding backrest

Extended Cab: 60/40 Split Bench

Optional Bucket Seats include Console

Steering Wheel, Sport

Storage Tray: Full width storage tray behind seat on floor

Sunshades: Cloth covered with storage strip on LH unit and visor mirror on RH unit

MODEL AND BODY

Description	Model No	Body
2-WHEEL-DRIVE MODELS		
*15,290.00 Sportside	CC10703	E62
*14,627.00 Fleetside	CC10703	E63
*13,154.00 Fleetside	CC10703	E63 & X81
*14,907.00 Fleetside	CC10903	E63
*12,954.00 Fleetside	CC10903	E63 & X81
*16,866.00 Sportside, Ext Cab	CC10753	E62
*16,454.00 Fleetside, Ext Cab	CC10753	E63
*17,297.00 Fleetside, Ext Cab	CC10953	E63

Description	Model No	Body
4-WHEEL-DRIVE MODELS		
*17,631.00 Sportside	CK10703	E62
*17069.00 Fleetside	CK10703	E63
*16,046.00 Fleetside	CC10703	E63 & X81
*17,368.00 Fleetside	CK10903	E63
*16,246.00 Fleetside	CK10903	E63 & X81
*19,191.05 Sportside, Ext Cab ..	CK10753	E62
*18,779.05 Fleetside, Ext Cab ..	CK10753	E63
*19,553.05 Fleetside, Ext Cab ..	CK10953	E63

*Includes Destination & Handling Charges

EMISSIONS (Must Specify One) (Refer Emission Requirements Section)

- FE9 Federal Emission Requirements
- NA6 High Altitude Emission Requirements
- NG1 New York State Emission Requirements
- YF5 California Emission Requirements
- NB8 California or New York State Emission Override (Reqs FE9 Federal or NA6 High Altitude Emissions)
- NC7 Federal or High Altitude Emission Override (Reqs NG1 New York State or YF5 California Emissions)

***GVWR SELECTOR**

Minimum Equipment Required for GVW Rating			
GVW Rating (lbs)	GAWR*		
	Front	Rear	
C10703			
5600	2950	3404	N/A Diesel Engine
C10903			
5600	2950	3404	Reqs YET or YEV Tires; N/A Diesel or KL5 Eng (w/X81 Reqs YET and LB4 Eng)
6100	3150	3686	Reqs YFL, YFM, YFN or YCN (w/X81 Reqs YFL and LB4 Eng)
K10703			
6100	3600	3750	N/A Diesel Eng
K10903			
6100	3600	3750	X81 Reqs LB4 Eng
C10753-C10953			
6200	3500	3686	None
K10753-K10953			
6200	3600	3750	N/A F44 Chassis or L56 Eng
6600	3600	3750	Reqs F44 Chassis (N/A L56 Eng w/K10953)
6800	3600	3750	Reqs F44 Chassis and L56 Eng (N/A K10753)

*GAWR's shown are the minimum for each axle with equipment listed. Other GAWR's are available, and they are determined as the minimum capacity of either axle, springs or tires.

POWER TEAMS (Must Specify Engine, Transmission and Rear Axle)

(Consult GVWR Selector For Minimum Equipment Required)

ENGINE	TRANSMISSION		AXLES			GVWR
	5-SP	AUTO	3.08	3.42	3.73	
CC10703						
LB4 V6 4.3 Liter (262 Cu In)--EFI	MM5		(c) GU4	GU6	--	5600
		MX0	(c) GU4	GU6	(a) GT4	5600
L03 V8 5.0 Liter (305 Cu In)--EFI	MM5		(b) GU4	(b) GU6	--	5600
		MX0	GU4	GU6	--	5600
L05 V8 5.7 Liter (350 Cu In)--EFI	MM5		GU4	GU6	--	5600
		MX0	GU4	GU6	GT4	5600
CK10703						
LB4 V6 4.3 Liter (262 Cu In)--EFI	MM5/MX0		--	--	GT4	6100
	MT8		--	--	(d) GT4	6100
L03 V8 5.0 Liter (305 Cu In)--EFI	MM5		--	(d) GU6	(d) GT4	6100
		MX0	--	GU6	GT4	6100
L05 V8 5.7 Liter (350 Cu In)--EFI	MM5	MX0	--	GU6	GT4	6100
	MT8		--	(d) GU6	(d) GT4	6100

- (a) Reqs NA6 High Altitude Emission
 (b) N/A YF5 California Emissions or NG1 New York State Emissions
 (c) N/A NA6 High Altitude Emissions
 (d) N/A YF5 California Emissions

CONTINUED ON PAGE 5

POWER TEAMS (Continued)

(Consult GVWR Selector For Minimum Equipment Required)

ENGINE	TRANSMISSION		AXLES			GVWR
	5-SP	AUTO	3.08	3.42	3.73	
CC10903						
LB4 V6 4.3 Liter (262 Cu In)--EFI	MM5		(d) GU4	GU6	--	5600/6100
	MT8		(c) GU4	(b) GU6	--	5600/6100
		MX0	(d)GU4	GU6	(a) GT4	5600/6100
L03 V8 5.0 Liter (305 Cu In)--EFI	MM5		(c) GU4	(b) GU6	--	5600/6100
		MX0	GU4	GU6	--	5600/6100
L05 V8 5.7 Liter (350 Cu In)--EFI	MM5		(c) GU4	(b) GU6	--	5600/6100
	MT8		(e) GU4	(b) GU6	--	5600/6100
		MX0	GU4	GU6	GT4	5600/6100
L49 Diesel V8 6.5 Liter (400 Cu In)	MT8	MX0	(c) GU4	(c) GU6	--	6100
L56 Turbo Diesel V8 6.5 Liter (400 Cu In)		MX0	(c) GU4	(c) GU6	--	6100
CK10903						
LB4 V6 4.3 Liter (262 Cu In)--EFI	MM5/MX0		--	--	GT4	6100
	MT8		--	--	(b) GT4	6100
L03 V8 5.0 Liter (305 Cu In)--EFI	MM5		--	(b) GU6	(b) GT4	6100
		MX0	--	GU6	(b) GT4	6100
L05 V8 5.7 Liter (350 Cu In)--EFI	MM5	MX0	--	GU6	GT4	6100
	MT8		--	(b) GU6	(b) GT4	6100
L49 Diesel V8 6.5 Liter (400 Cu In)	MT8	MX0	--	(c) GU6	(c) GT4	6100
L56 Turbo Diesel V8 6.5 Liter (400 Cu In)		MX0	--	(c) GU6	(c) GT4	6100

- (a) Reas NA6 High Altitude Emission
 (b) N/A YF5 California Emission; NG1 N/A 5600 GVWR
 (c) Reas FE9 Federal w/5600 GVWR; Reqs FE9 Federal Emissions or NG1 New York State Emissions w/6100 GVWR
 (d) N/A NA6 High Altitude Emission
 (e) Reas FE9 Emissions w/5600 GVWR. N/A YF5 Emissions w/6100 GVWR

CONTINUED ON PAGE 6

POWER TEAMS (Continued)

(Consult GVWR Selector For Minimum Equipment Required)

ENGINE	TRANSMISSION		AXLES			GVWR
	5-SP	AUTO	3.08	3.42	3.73	
CC10753						
LB4 V6 4.3 Liter (262 Cu In)--EFI	MM5		--	GU6	--	6200
	MT8		--	(b) GU6	--	6200
		MX0	--	GU6	(a) GT4	6200
L03 V8 5.0 Liter (305 Cu In)--EFI	MM5		(b) GU4	(b) GU6	--	6200
		MX0	GU4	GU6	--	6200
L05 V8 5.7 Liter (350 Cu In)--EFI	MM5		GU4	GU6	--	6200
	MT8		(b) GU4	(b) GU6	--	6200
		MX0	(d) GU4	GU6	GT4	6200
(e) L49 Diesel V8 6.5 Liter (400 Cu In)	MT8	MX0	(c) GU4	(c) GU6	--	6200
(e) L56 Turbo Diesel V8 6.5 Liter (400 Cu In)		MX0	(c) GU4	(c) GU6	--	6200
CK10753						
LB4 V6 4.3 Liter (262 Cu In)--EFI	MM5/MT8	MX0	--	--	(b) GT4	6200
	MM5	MX0	--	--	(c) GT4	6600
L03 V8 5.0 Liter (305 Cu In)--EFI	MM5		--	(b) GU6	(b) GT4	6200
	MM5		--	(c) GU6	(c) GT4	6600
		MX0	--	GU6	GT4	6200
		MX0	--	(c) GU6	(c) GT4	6600
L05 V8 5.7 Liter (350 Cu In)--EFI	MM5/MX0		--	GU6	GT4	6200/6600
	MT8		--	(b) GU6	(b) GT4	6200/6600
(e) L49 Diesel V8 6.5 Liter (400 Cu In)	MT8	MX0	--	(c) GU6	(c) GT4	6600
(e) L56 Turbo Diesel V8 6.5 Liter (400 Cu In)		MX0	--	(c) GU6	(c) GT4	6600

- (a) Reqs NA6 High Altitude Emission
(b) N/A YF5 California Emission
(c) Reqs FE9 Federal or NG1 New York State Emissions
(d) N/A NA6 High Altitude Emission
(e) w/E62 w/o Silverado Decor Reqs V27 Bumper

CONTINUED ON PAGE 7

POWER TEAMS (Continued)

(Consult GVWR Selector For Minimum Equipment Required)

ENGINE	TRANSMISSION		AXLES				GVWR
	5-SP	AUTO	3.08	3.42	3.73	4.10	
CC10953							
L03 V8 5.0 Liter (305 Cu In)--EFI	MM5	MX0	(c) GU4	(b) GU6	--	--	6200
L05 V8 5.7 Liter (350 Cu In)--EFI	MM5		(c) GU4	(b) GU6	--	--	6200
		MX0	(a) GU4	GU6	GT4	--	6200
L49 Diesel V8 6.5 Liter (400 Cu In)	MT8	MX0	(c) GU4	(c) GU6	--	--	6200
L56 Turbo Diesel V8 6.5 Liter (400 Cu In)		MX0	(c) GU4	(c) GU6	--	--	6200
CK10953							
L03 V8 5.0 Liter (305 Cu In)--EFI	MM5	MX0	--	(c) GU6	(c) GT4	--	6200/6600
L05 V8 5.7 Liter (350 Cu In)--EFI	MM5		--	(b) GU6	(b) GT4	--	6200/6600
		MX0	--	GU6	GT4	--	6200
		MX0	--	(b) GU6	GT4	(d) GT5	6600
L49 Diesel V8 6.5 Liter (400 Cu In)	MT8	MX0	--	(c) GU6	(c) GT4	--	6600
L56 Turbo Diesel V8 6.5 Liter (400 Cu In)		MX0	--	(c) GU6	(c) GT4	--	6800

- (a) N/A NA6 High Altitude Emission
 (b) N/A YF5 California Emission
 (c) Reqs FE9 Federal or NG1 New York State Emissions
 (d) Reqs NA6 High Altitude Emission

CAPACITIES

C10703-C10903	
SPRINGS:	
Front	2950
Rear	3750
AXLES:	
Front	3150
Rear	3750

K10703	
SPRINGS:	
Front	3600
Rear	3750
AXLES:	
Front	3925
Rear	3750

K10903	
SPRINGS:	
Front	3600
Rear	3750
AXLES:	
Front	3925
Rear	3750

C10753-C10953	
SPRINGS:	
Front	3500 Base
	3600 w/ZQ8
Rear	3750
AXLES:	
Front	3600
Rear	3750

K10753-K10953	
SPRINGS:	
Front	3600
Rear	3750
AXLES:	
Front	3925
Rear	3750

**TIRES: (Without X81 Work Package, Must Specify Front, Rear and Spare
(With X81 Work Package, Must Specify Front and Rear. Spare is Optional With
PEG PWT1)**

Description	Highway		On-Off Road		
	Front	Rear	Front	Rear	Spare
C10703-C10903					
TUBELESS Steel Belted Radial					
P225/75R15 B/W	XET	YET			ZET
(a) P225/75R15 W/L	XEV	YEV			ZEV
P235/75R15 B/W	XFL	YFL			ZFL
(a) P235/75R15 W/S	XFM	YFM			ZFM
(a) P235/75R15 W/L	XFN	YFN			ZFN
(b) P275/60R15 B/W	XCN	YCN			ZCN
K10703-K10903					
TUBELESS Steel Belted Radial					
LT225/75R16-C B/W	XHE	YHE			ZHE
(a) LT225/75R16-C WOL			XHN	YHN	ZHN
LT225/75R16-C B/W			XHJ	YHJ	ZHJ
(c) LT265/75R16-C B/W			XGL	YGL	ZGL
(c) LT265/75R16-C WOL			XGM	YGM	ZGM
C10753-C10953					
TUBELESS Steel Belted Radial					
P235/75R15 B/W	XFL	YFL			ZFL
P235/75R15 W/S	XFM	YFM			ZFM
P235/75R15 W/L	XFN	YFN			ZFN
(b) P275/60R15 B/W	XCN	YCN			ZCN
K10753-K10953					
TUBELESS Steel Belted Radial					
LT245/75R16-C B/W	XBK	YBK			ZBK
LT245/75R16-C B/W			XBN	YBN	ZBN
LT245/75R16-C WOL			XBX	YBX	ZBX
(c) LT265/75R16-C B/W			XGL	YGL	ZGL
(c) LT265/75R16-C WOL			XGM	YGM	ZGM

- (a) N/A X81 Work Pkg
- (b) Reqs ZQ8 Sport Chassis
- (c) w/o L05 Eng Reqs GT4 Axle; N/A X81 Work Pkg

- B/W=Blackwall
- W/S=White Stripe
- W/L =White Lettered
- WOL=White Outlined Letter

X81 WORK TRUCK PACKAGE INCLUDES:

(C-K10*03 Only) (Reqs LB4 Eng, Solid Paint and Standard Interior w/Bench Seat)

MUST SPECIFY:

AXLE, EMISSION, ENGINE, TIRES AND TRANSMISSION

**No Deletions Allowed, Additional Options/Upgrades (Where Indicated)
May be Ordered from the Custom Ordering Option Listing**

		P W T 1	P W T 2
Preferred Equipment Group 1			
Work Truck Package	X81	x	x
Body: Fleetside	E63	x	x
Preferred Equipment Group 2			
Bumper, Rear Step	V43		x
Radio: ETR AM Radio (A)	UP4		x
Tire, Spare	Z**		x
Wheel Trim, Rally (B)	P06		x

Allowable Substitutions (Where Available)
(A) UP4: May substitute UM7 or UM6 Radio
(B) P06: May substitute N83 Wheels (C1500 Only)

Preferred Equipment Group Prices

N/C	PWT1
	PWT2
*512.00	C1500
*573.00	K1500
**(-350.00)	PEG 2 SAVINGS

*The Preferred Equipment Group MSRPs Reflect the Basic Group Equipment Prices. For any Option Additions, Upgrades or Substitutions, Refer to the Vehicle Price Schedule for any Price Differential.
**PEG Savings Amount represents the savings for Preferred Equipment Groups.

X81 WORK TRUCK 1500 PICKUP

ADDITIONAL OPTIONS

INCL w/PEG	OPTION	
N.C.	R8S	ACKNOWLEDGEMENTS:
N.C.	R8T	Multiple Order Numbers
805.00	C60	Preliminary Invoice
		AIR CONDITIONING: (Incls R134A Refrigerant)
		AXLES, REAR: (Refer Power Teams Chart for Availability)
N.C.	GU4	3.08 Ratio
N.C.	GU6	3.42 Ratio
N.C.	GT4	3.73 Ratio
252.00	G80	Locking Differential (N/A GU4 Axle)
225.00	BZY	BEDLINER: Under Rail
N.C.	1,2 E63	BODY CODE: 8 Ft. Fleetside
	2 V43	BUMPER: Painted, Rear Step
N.C.		w/PWT2
130.00		w/PWT1
33.00	V10	COLD-CLIMATE PACKAGE: (Incls Eng Block Heater)
		COOLING SYSTEM:
135.00	KC4	Engine Oil (Reqs MM5 or MT8 Trans)
198.00	V08	Engine and Transmission Oil (Reqs MX0 Trans)
		EMISSIONS: (Refer Emission Requirement Tab Section)
N.C.	FE9	Federal Emission Requirements
N.C.	NA6	High Altitude Emission Requirements
	NG1	New York State Emission Requirements
N.C.		Above 5600 GVWR
100.00		w/5600 GVWR
100.00	YF5	California Emission Requirements
N.C.	NB8	California or New York State Emission Override (Reqs FE9 Federal or NA6 High Altitude Emissions)
N.C.	NC7	Federal or High Altitude Emission Override (Reqs NG1 New York or YF5 California Emissions)
N.C.	LB4	ENGINE: 4.3 Liter (262 Cu In)--EFI V6 (Refer Power Teams Chart for Availability)
		GVWR: (Refer GVWR Chart)
N.C.	VK3	LICENSE PLATE BRACKET: Front
N.C.	ZY1	PAINT, EXTERIOR: Solid (Refer Color/Trim Chart for Availability)
		RADIO EQUIPMENT: (Incls Fixed Mast Antenna)
N.C.	2 UP4	Electronically Tuned AM Radio
162.00		w/PWT2
		w/PWT1
	UM7	Electronically Tuned AM/FM Stereo Radio w/Seek-Scan and Digital Clock
170.00		w/PWT2
332.00		w/PWT1
	UM6	Electronically Tuned AM/FM Stereo Radio w/Seek-Scan, Stereo Cassette Tape and Digital Clock
292.00		w/PWT2
454.00		w/PWT1
		SEAT TRIM: (Refer Color/Trim Chart for Availability)
N.C.	V**1	Vinyl Bench Seat
N.C.	C**1	Cloth Bench Seat
	F51	SHOCK ABSORBERS: Front and Rear, Heavy Duty (Incl w/VYU Snow Plow Pkg)
N.C.		w/VYU
40.00		w/o VYU
95.00	NZZ	SKID PLATE: Off-Road (K10903 Only)
158.00	VYU	SNOW PLOW PREP PACKAGE: (K10903) (Incls F60 Front Springs and F51 H.D. Shock Absorbers)
		(Reqs KC4 or V08 Eng Oil Cooling)
	F60	SPRINGS, FRONT: Heavy Duty (K10903 Only) (Incl w/VYU Snow Plow)
N.C.		w/VYU
63.00		w/o VYU
		TIRES: (Refer to Tire Chart for Availability and vehicle Price Schedule for Prices)
38.00	V76	TOW HOOKS: Two Front (Std on K1500)
		TRANSMISSION: (Refer Power Teams Chart for Availability)
N.C.	MM5	5-Speed Manual with Overdrive
98.00	MT8	5-Speed Manual with Deep Low and Overdrive, Heavy-Duty
930.00	MX0	4-Speed Electronically Controlled Automatic with Overdrive
	2 P06	WHEEL TRIM: Rally Wheel Trim
N.C.		w/PWT2
60.00		w/PWT1
	N83	WHEELS, CHROME: (C1500 Only)
239.00		w/PWT2
299.00		w/PWT1
113.00	A28	WINDOW: Sliding Rear

MUST SPECIFY:

AXLE, EMISSION, ENGINE, TIRES AND TRANSMISSION

No Deletions Allowed, Additional Options/Upgrades (Where Indicated)
May be Ordered from the Custom Ordering Option Listing

		CHEYENNE		SILVERADO	
		P 1 A 1	P 1 A 2	P 1 A 3	P 1 A 4
Preferred Equipment Group 1					
Body: Fleetside (E62 may be Substituted on C-K107*3 Models)	E63	x	x	x	x
Preferred Equipment Group 2					
Air Conditioning	C60		x	x	x
Radio: AM/FM Stereo w/Clock (A)	UM7		x	x	N/I
Preferred Equipment Group 3					
Silverado Decor	YE9			x	x
Lighting, Auxiliary	TR9			x	x
Mirrors: Below-Eye-Line, Stainless Steel (B)	D45			x	x
Preferred Equipment Group 4					
Convenience Group: Tilt-Wheel and Speed Control	ZQ3				x
Convenience Group: Power Door Locks and Windows	ZQ2				x
Radio: AM/FM Stereo w/Tape and Clock (C)	UM6				x

Allowable Substitutions (Where Available):
(A) UM7: May substitute UM6 or UX1 Stereo Radio
(B) D45: May substitute DF2 Mirrors
(C) UM6: May substitute UX1 Stereo Radio

Preferred Equipment Group Prices

N/C P1A1
**(-890.00) w/MX0

*975.00 P1A2
**(-400.00) PEG 2 SAVINGS REGULAR CAB
**(-1290.00) w/MX0 and LB4
**(-400.00) EXTENDED CAB SAVINGS

Preferred Equipment Group Prices

*1912.00 P1A3
**(-650.00) PEG 3 SAVINGS
**(-1150.00) w/MX0 and LB4/L03

*2784.00 P1A4
**(-700.00) PEG 4 SAVINGS
**(-1200.00) w/MX0 and LB4/L03

*The Preferred Equipment Group MSRPs Reflect the Basic Group Equipment Prices. For any Option Additions,Upgrades or Substitutions, Refer to the Vehicle Price Schedule for any Price Differential.
**PEG Savings Amount represents the savings for Preferred Equipment Groups.

ADDITIONAL OPTIONS

	INCL w/PEG	OPTION	
N.C.		R8S	ACKNOWLEDGEMENTS:
N.C.		R8T	Multiple Order Numbers
			Preliminary Invoice
N.C.	2,3,4	C60	AIR CONDITIONING: (Incls R134A Refrigerant)
805.00			w/P1A2, P1A3 or P1A4
			w/P1A1
		V22	APPEARANCE PACKAGE: (Incls Chrome Grille, Composite Halogen Headlamps and Dual Horns) (Incl w/Silverado Decor)
N.C.			w/P1A3 or P1A4
191.00			w/P1A1 or P1A2
			AXLES, REAR: (Refer Power Teams Chart for Availability)
N.C.		GU4	3.08 Ratio
N.C.		GU6	3.42 Ratio
N.C.		GT4	3.73 Ratio
135.00		GT5	4.10 Ratio (Incls HD Cooling and Trans Oil Cooler)
252.00		G80	Locking Differential (N/A GU4 Axle)
134.00		TP2	BATTERY: Heavy-Duty, Auxiliary (N/A LB4 or Diesel Eng)
225.00		BZY	BEDLINER: Under Rail (Reqs E63 Body) (N/A P13 Wheel Carrier)
			BODY CODE:
N.C.		E62	Sportside Body
N.C.	1,2,3,4	E63	Fleetside Body
			BUMPER EQUIPMENT:
130.00		V43	Bumper, Painted. Rear Step (Reqs E63 Body)
		VG3	Bumper, Chromed. Front Deluxe w/Rub Strip (Incl w/Silverado Decor)
N.C.			w/P1A3 or P1A4
26.00			w/P1A1 or P1A2
229.00		VB3	Bumper, Chromed. Rear Step w/Rub Strip (Reqs VG3 Bumper or Silverado Decor)
		V27	Bumper Guards, Front. Black (Reqs VG3 Bumper or Silverado Decor) (Incl w/Diesel Eng with Silverado Decor)
N.C.			w/Silverado Decor w/Diesel Eng
32.00			w/Silverado Decor or E62 w/o Diesel Eng
N.C.		P13	CARRIER, SPARE WHEEL AND TIRE: Side Mounted (N/A C-K107*3, ZQ8 Sport Chassis or BZY Bedliner)
			CHASSIS EQUIPMENT:
N.C.		F44	Heavy-Duty (K1500 Extended only)(Incl w/L49 or L56 Eng)
230.00			w/Diesel Eng
270.00			w/o Diesel Eng
		Z71	Off-Road Package (K1500 Only) (Reqs XGL or XGM Tires) (N/A F51 Shocks or F60 Springs)
			(Incls NZZ Skid Plate and Bilstein Shocks)
		ZQ8	Sport Handling Package (C1500 Only) (Reqs XCN Tires) (N/A Diesel Eng, F51 Shocks, P13 Carrier, P01 or P06 Wheel Covers or N90 Wheels) (Incls Bilstein Gas Shocks and N83 Chrome Wheels)
974.00			w/P1A3 or P1A4
1065.00			w/P1A1 or P1A2
33.00		V10	COLD-CLIMATE PACKAGE: (N/A Diesel Eng) (Incls Eng Block Heater)
			CONVENIENCE GROUP:
N.C.	4	ZQ3	Tilt Wheel and Speed Control
383.00			w/P1A4
			w/P1A1, P1A2 or P1A3
N.C.	4	ZQ2	Power Door Locks and Windows
367.00			w/P1A4
			w/P1A1, P1A2 or P1A3
			COOLING SYSTEM: (Incl w/Z82 Trailering)
N.C.		KC4	Engine Oil (Reqs MM5 or MT8 Trans) (N/A Diesel Eng or GT5 Axle)
135.00			w/Z82
			w/o Z82
N.C.		V08	Engine and Transmission Oil (Reqs MX0 Transmission) (N/A Diesel Eng or GT5 Axle)
135.00			w/Z82
			w/o Z82
N.C.		KNP	Transmission, Heavy-Duty, Auxiliary (Reqs MX0 Trans) (N/A LB4 or L03 Eng) (w/L05 Eng N/A GU4 or GT5 Axle) (Incl w/Z82 Trailering when L05 Eng, MX0 Trans and GT4 Axle are ordered)
96.00			w/Z82
154.00			w/o Z82
		C49	DEFOGGER: Rear Window Electric (Reqs Silverado Decor) (N/A A28 Window) (N/A C-K10*03)
			EMISSIONS: (Refer Emission Requirement Tab Section)

ADDITIONAL OPTIONS

INCL w/PEG	OPTION	
		EMISSIONS: (Refer Emission Requirement Tab Section)
N.C.	FE9	Federal Emission Requirements
N.C.	NA6	High Altitude Emission Requirements
	NG1	New York State Emission Requirements w/5600 GVWR Above 5600 GVWR
100.00		
N.C.	YF5	California Emission Requirements
N.C.	NB8	California or New York Emission Override (Reqs FE9 Federal or NA6 High Altitude Emissions)
N.C.	NC7	Federal or High Altitude Emission Override (Reqs NG1 New York or YF5 California Emissions)
		ENGINES: (Refer Power Teams Chart for Availability)
N.C.	LB4	4.3 Liter (262 Cu In)--EFI V6
	L03	5.0 Liter (305 Cu In)--EFI V8 w/C-K10953
N.C.		w/C-K10*03 or C-K10953
575.00	L05	5.7 Liter (350 Cu In)--EFI V8 w/C-K10953
290.00		w/C-K10*03 or C-K10753
865.00	L49	6.5 Liter V8 Naturally Aspirated Diesel (400 Cu In) (Incls V27 Bumper w/Silverado Decor) w/C-K10953
2295.00		w/C-K10*03 or C-K10753
2870.00	L56	6.5 Liter V8 Turbo Diesel (400 Cu In) (Incls V27 Bumper w/Silverado Decor) w/C-K10953
		w/C-K10*03 or C-K10753
3095.00	KL5	Alternative Fuel (LPG or CNG Conversion Ready) (N/A C10703 or C-K10953 Models or w/GU4 Axle) (Reqs L05 Eng and MX0 Trans) (C10903 Reqs 6100 GVWR) (K10753 Reqs 6200 GVWR) (C10753 Reqs GT4 or GU6 Axle) (K10903 Reqs GT4 Axle)
3670.00	BG9	FLOOR COVERING: Full Floor, Rubber, Color-Keyed (Replaces Carpeting and Floor Mats) (Reqs Silverado Decor) w/C-K10*53 w/C-K10*03
125.00		
(-36.00)	AJ1	GLASS: Deep Tinted Solar-Ray (Incls A20 Swing-Out Window) (N/A C-K10*03) (When A28 Window or C49 Defogger is Specified, Rear Window is Light Tint Glass) w/P1A3 or P1A4 and A28 or C49 w/P1A3 or P1A4 w/o A28 or C49 w/P1 A1 or P1A2 and A28 or C49 w/P1A1 or P1A2 w/o A28 or C49
(-20.00)		
72.00		
107.00		
115.00		
150.00		
		LAMPS:
	C95	Dome and Reading (Incl w/TR9 Aux Lighting) w/TR9 w/o TR9
N.C.	U01	Roof Marker (N/A YF5 Calif Emissions or NG1 w/5600 GVWR)
33.00	VK3	LICENSE PLATE BRACKET: Front
52.00	TR9	LIGHTING, AUXILIARY: (Incls C95 Dome and Reading Lamps, Ashtray, Glovebox and Underhood Lamps) w/P1A3 or P1A4 w/P1A1 or P1A2
N.C.		
94.00		
		MIRRORS, EXTERIOR:
	3,4	D45 Below-Eye-Line Type. Stainless Steel w/P1A3 or P1A4 w/P1A1 or P1A2
N.C.		
45.00	DF2	Camper Type. Stainless Steel w/P1A3 or P1A4 w/P1A1 or P1A2
8.00		
53.00	B85	MOLDING: Exterior, Bright (Incl w/Silverado Decor) (Incls Body Side Molding) (Also incl Bright Wheel Opening w/E63 Fleetside w/o ZQ8 Chassis) w/P1A3 or P1A4 w/P1A1 or P1A2 w/E63 w/o ZQ8 w/P1A1 or P1A2
N.C.		
107.00		
76.00		
		PAINT, EXTERIOR: (Refer Color/Trim Chart for Availability)
N.C.	ZY1	Solid
132.00	ZY2	Conventional Two-Tone
243.00	ZY4	Deluxe Two-Tone (N/A E62 Body)

ADDITIONAL OPTIONS

	INCL w/PEG	OPTION	
			RADIO EQUIPMENT: (Electronically Tuned AM Radio is Standard)
N.C. 170.00	2.3	UM7	Electronically Tuned AM/FM Stereo Radio w/Seek-Scan and Digital Clock (Incl w/Silverado Decor) w/P1A2 or P1A3 w/P1A1
N.C. 122.00 292.00	4	UM6	Electronically Tuned AM/FM Stereo Radio w/Seek-Scan, Stereo Cassette Tape and Digital Clock w/P1A4 w/P1A2 or P1A3 w/P1A1
150.00 272.00 442.00 (-117.00) 240.00		UX1	Electronically Tuned AM Stereo/FM Stereo Radio w/Seek-Scan, Stereo Cassette Tape w/Search and Repeat, Graphic Equalizer and Digital Clock w/P1A4 w/P1A2 or P1A3 w/P1A1
		UL5	Radio Delete (Reqs P1A1)
(-395.00)		AG9	SEAT: Power Driver's Seat (Reqs Silverado Decor and Custom Cloth Split Bench or Bucket Seats) (N/A C-K 10*03)
		YG4	SEAT DELETE: Rear (Reqs Cheyenne Decor)(N/A C-K10*03)
			SEAT TRIM: (Refer Color/Trim Chart for Availability)
N.C. N.C.		V**1	Vinyl Bench Seat (N/A Ext Cab)
		C**1	Cloth Bench Seat (N/A Ext Cab)
115.00 289.00		V**2	Vinyl Reclining Low Back Bucket Seat w/C-K10*53 w/C-K10*03
115.00 289.00		C**2	Cloth Reclining Low Back Bucket Seat w/C-K10*53 w/C-K10*03
N.C. 174.00		V**3	Vinyl Reclining Split Bench Seat w/C-K10*53 w/C-K10*03
N.C. 174.00 N.C.		C**3	Cloth Reclining Split Bench Seat w/C-K10*53 w/C-K10*03
N.C. 174.00		L**1	Custom Cloth Bench Seat (N/A Ext Cab)
		L**3	Custom Cloth Reclining Split Bench Seat w/C-K10*53 w/C-K10*03
291.00 490.00		L**6	Custom Cloth Reclining High Back Bucket Seats w/C-K10*53 w/C-K10*03
N.C. 40.00		F51	SHOCK ABSORBERS: Front and Rear, Heavy Duty (N/A Z71 Off-Road Chassis or ZQ8 Sport Chassis) (Incl w/Z82 Trailering or VYU Snow Plow Pkg) w/Z82 or VYU w/o Z82 or VYU
N.C. 95.00		NZZ	SKID PLATE: Off-Road (K1500 Only) (Incls Engine Front Differential and Transfer Case Shield) (Incl w/Z71 Off-Road Chassis) w/Z71 w/o Z71
55.00 158.00		VYU	SNOW PLOW PREP PACKAGE: (K1500 Only) (N/A Diesel Eng) (Reqs KC4 or V08 Eng Oil Cooler) (N/A CK10*53) (w/o Z71 Off-Road Package Incls F60 Front Springs and F51 Shock Absorbers) w/Z71 w/o Z71
N.C. 63.00 59.00		F60	SPRINGS: Front, Heavy Duty (K1500 Only) (N/A Diesel Eng or Z71 Off-Road Chassis) (Incl w/VYU Snow Plow Pkg) w/VYU w/o VYU
38.00		U16	TACHOMETER
		V76	TIRES: Tubeless, Steel Belted Radial (Refer Tire Chart for Availability; Vehicle Price Schedule for Prices) TOW HOOKS: Two Front (Standard on K1500 Models)

ADDITIONAL OPTIONS

INCL w/PEG	OPTION	
	Z82	TRAILERING SPECIAL EQUIPMENT: Heavy-Duty (Incls Trailer Hitch and Wiring Harness)(w/o Z71 or ZQ8 Chassis Incls F51 Shock Absorbers) (w/Z71 or ZQ8 Chassis Incls Bilstein Shocks) (Incls KC4 or V08 Eng Oil Cooler w/o Diesel Eng or GT5 Axle) (C-K10903 or C-K10953 Reqs VB3 or V43 Bumper) (w/MT8 Trans: K10703, C-K10753, C10903 Reqs L05 Eng; K10903 Reqs L49 Eng w/GT4 Axle or L05 Eng; K10953 Reqs L49 Eng and GT4 Axle) (N/A MM5 Trans) (w/L05 Eng, MX0 Trans and GT4 Axle Incls KNP Trans Cooler) With Diesel Engine w/Z71 w/o Z71 Without Diesel Engine w/ZQ8 or Z71 or VYU w/o ZQ8 or Z71 or VYU
210.00		
250.00		
345.00		
385.00		
N.C.	MM5	TRANSMISSIONS: (Refer Power Teams Chart for Availability) 5-Speed Manual with Overdrive
N.C.	MT8	5-Speed Manual with Deep Low and Overdrive, Heavy-Duty w/Diesel Eng w/o Diesel Eng
98.00		
930.00	MX0	4-Speed Electronically Controlled Automatic with Overdrive
		WHEEL TRIM: (N/A ZQ8 Sport Chassis) Wheel Covers (N/A Silverado Decor) Rally Wheel Trim (Incl w/Silverado Decor) w/P1A3 or P1A4 w/P1A1 or P1A2
42.00	P01	
	P06	
N.C.		
60.00		
		WHEELS: (Spare is base steel) Aluminum (C1500 Only) (N/A ZQ8 Sport Chassis) w/P1A3 or P1A4 w/P1A1 or P1A2
250.00	N90	
310.00		
	PF4	Aluminum (K1500 Only) w/P1A3 or P1A4 w/P1A1 or P1A2
250.00		
310.00		
	N83	Chrome Wheel (C1500 Only) (Incl w/ZQ8 Sport Chassis) w/ZQ8 Sport Chassis w/P1A3 or P1A4 w/P1A1 or P1A2 or w/o ZQ8
N.C.		
239.00		
299.00		
		WINDOWS: Sliding Rear (N/A C49 Defogger) Swing-out, Rear Quarter (Incl W/Silverado Decor or AJ1Glass) w/P1A3 or P1A4 or AJ1 w/P1A2 or P1A2 w/o AJ1
113.00	A28	
	A20	
N.C.		
43.00		

C/K 1500 PICKUP
INTERIOR AND EXTERIOR COLOR AVAILABILITY CHART
WITH ZY4 PAINT SCHEMES
(ZY4 N/A w/E62 BODY CODE OR X81 WORK TRUCK)

PLEASE NOTE: Below are the interior trim color and exterior paint combinations recommended by Chevrolet. They are the only available interior and exterior combinations allowed.

TRIM LEVEL Seat Type	Decor	INTERIOR COLORS			
		Beige	Blue	Garnet	Gray
CHEYENNE	Std				
Vinyl Bench Seat (N/A Ext Cab)		VUU1	VDD1	VRR1	VQQ1
Cloth Bench Seat (N/A Ext Cab)		CUU1	CDD1	CRR1	CQQ1
Vinyl Reclining Low Back Bkt Seat		VUU2	VDD2	VRR2	VQQ2
Cloth Reclining Low Back Bkt Seat		CUU2	CDD2	CRR2	CQQ2
Vinyl Reclining Split Bench Seat		VUU3	VDD3	VRR3	VQQ3
Cloth Reclining Split Bench Seat	CUU3	CDD3	CRR3	CQQ3	
SILVERADO	YE9				
Vinyl Bench Seat (N/A Ext Cab)		VUU1	VDD1	VRR1	VQQ1
Custom Cloth Bench Seat (N/A Ext Cab)		LUU1	LDD1	LRR1	LQQ1
Vinyl Reclining Low Back Bkt Seat		VUU2	VDD2	VRR2	VQQ2
Vinyl Reclining Split Bench Seat		VUU3	VDD3	VRR3	VQQ3
Custom Cloth Reclining Split Bench Seat		LUU3	LDD3	LRR3	LQQ3
Custom Cloth Reclining High Back Bucket Seats	LUU6	LDD6	LRR6	LQQ6	

EXTERIOR COLORS	Color Code 1	Color Code 2	INTERIOR & EXTERIOR COMBINATIONS SHOWN ARE THE ONLY COMBINATIONS AVAILABLE				STRIPE COLORS
Autumnwood, Dk (Met)/ Autumnwood, Lt (Met)	56	55	x				Beige/Autumnwood
Autumnwood, Lt (Met)/ Autumnwood, Dk (Met)	55	56	x				Beige/Autumnwood
Black, Onyx/Autumnwood, Lt (Met)	41	55	x				Beige/Black
Black, Onyx/Quicksilver (Met)	41	96			x	x	Gunmetal/Red
Black, Onyx/Red, Victory (Met)	41	74				x	Silver/Red
Blue, Indigo (Met)/Autumnwood, Lt (Met)	39	55	x	x			Beige/Autumnwood
Blue, Indigo (Met)/Blue, Lt Quasar (Met)	39	20		x		x	Blue/Silver
Blue, Indigo (Met)/Quicksilver (Met)	39	96		x		x	Blue/Silver
Blue, Indigo (Met)/White, Summit	39	50		x		x	Blue/Silver
Blue, Lt Quasar (Met)/Blue, Indigo (Met)	20	39		x		x	Blue/Silver
Blue, Lt Quasar (Met)/Quicksilver (Met)	20	96		x		x	Blue/Silver
Blue, Lt Quasar (Met)/White, Summit	20	50		x		x	Blue/Silver
Green, Teal (Met)/Quicksilver (Met)	38	96				x	Teal/Silver
Quicksilver (Met)/Black, Onyx	96	41			x	x	Gunmetal/Red
Quicksilver (Met)/Blue, Indigo (Met)	96	39		x		x	Blue/Silver
Quicksilver (Met)/Blue, Lt Quasar (Met)	96	20		x		x	Blue/Silver
Quicksilver (Met)/Green, Teal (Met)	96	38				x	Teal/Silver
Quicksilver (Met)/Red, Dk Garnet (Met)	96	84			x	x	Gunmetal/Silver
Quicksilver (Met)/Red, Victory	96	74			x	x	Gunmetal/Silver
Red, Dk Garnet (Met)/Quicksilver (Met)	84	96			x	x	Gunmetal/Silver
Red, Dk Garnet (Met)/White, Summit	84	50			x	x	Gunmetal/Silver
Red, Victory/Black, Onyx	74	41			x	x	Silver/Red
Red, Victory/Quicksilver (Met)	74	96			x	x	Gunmetal/Red
Red, Victory/White, Summit	74	50			x	x	Gunmetal/Red

MODELS

Sportside 2-wheel drive (CC10703)	3
Sportside 4-wheel drive (CK10703)	3

DIMENSIONS

Wheelbase (inches)	117.5
Cab-Axle (inches)	41.8
Length (overall - inches)	194.0
Width (overall-inches)	77.1
Box Size	
Length (overall - inches)	78.7
Box Depth (inches)	19.3
Payload (pounds)	
CC10703	1872
CK10703	1935
GVWR	
CC10703	5600
CK10703	6100
Fuel Tank Capacity	25 Gal.

POWER TEAMS

- Standard Engine
RPO LB4 4.3 Liter (262 Cu In) V6 with Electronic Fuel Injection (EFI)
- Standard Transmission
RPO MM5 5-Speed Manual

STANDARD EQUIPMENT SUMMARY

EXTERIOR

- Air Dam:
 - CC10703 Black with fog lamps
 - CK10703 Black with tow hooks
- Battery: 600 Cold Cranking Amps
- Brakes: Power assisted front disc, rear drum. Rear wheel anti-lock
- Bumper: Color-keyed front and rear bumper w/step pad
- Decal: Chevrolet on tailgate
- Grille: Color-keyed grille with gold bowtie
- Headlamps: Dual Composite
- Horn: Dual low and high note electric
- Mirrors: Color-keyed RH and LH fixed with adjustable heads (6" x 4.5")
- Radiator, Heavy-Duty
- Spare Tire: Full size
- Tires:
 - CC10703-P235/75R15 All Seasons Steel Belted Radial Ply B/W
 - CK10703-LT265/75R16C On-Off Road B/W
- Wheels: Aluminum
- Windshield Wipers: Intermittent

INTERIOR

- Cigarette Lighter
- Cupholders, Mounted Under Dash with Bench or 60/40 Seat(s). Located in Center Console w/ Bucket Seats
- Decor: Silverado
- Dome Lamp w/dual door jam switches
- Door Guard Beams: Side
- Floor Covering: Color-keyed carpeting
- Floor Mats: Front removable color-keyed
- Gages: Engine temperature, fuel level, odometer, oil pressure, speedometer, telltale lights, trip odometer and voltmeter
- Glass: Tinted, Solar-Ray, all windows
- Glove Box: Latched door and beverage holder
- Headliner: Color-keyed cloth including matching retainer moldings
- Heater: Deluxe heater with windshield and side window defoggers
- Mirror: Rearview
- Radio: Electronically-tuned AM/FM stereo with seek-scan and digital clock
- Scotchgard Fabric Protector on carpeting, cloth trim and door panels
- Seats: Choice of custom vinyl or custom cloth front bench seat with folding backrest. Optional bucket seats include console
- Steering Wheel, Sport
- Stop Lamp, Center-Mounted with Cargo Lamp
- Storage Tray: Full width storage tray behind seat on floor
- Sunshades: Cloth covered with storage strap on LH unit and visor mirror on RH unit

MODEL AND BODY

	Description	Model No	Body
	2-WHEEL-DRIVE MODEL		
*15,290.00	Sportside	CC10703	E62

	Description	Model No	Body
	4-WHEEL-DRIVE MODEL		
*17,631.00	Sportside	CK10703	E62

*Includes Destination & Handling Charges

REFER POWER TEAM CHART (Pages 4- 7) FOR ENGINE, TRANSMISSION and AXLE AVAILABILITY AND (Page 3) FOR GVWR SELECTOR AND CAPACITIES

TIRES: Must Specify Front, Rear and Spare (Incls Tire Carrier)

Description	Highway		On-Off Road		Spare
	Front	Rear	Front	Rear	
TUBELESS Steel Belted Radial					
(a) P235/75R15 B/W	XFL	YFL			ZFL
(b) LT265/75R16-C B/W			XGL	YGL	ZGL
(c) P275/60R15 B/W	XCN	YCN			ZCN

(a)C10703 Only

(b)K10703 Only; w/LB4 or L03 Eng Reqs GT4 Axle Ratio

(c)C10703 Only; Reqs ZQ8 Sport Chassis

B/W = Blackwall

MUST SPECIFY:

AXLE, EMISSION, ENGINE, TIRES AND TRANSMISSION

**No Deletions Allowed, Additional Options/Substitutions (Where Indicated)
May be Ordered from the Custom Ordering Option Listing**

SILVERADO

**P
S
P
1**

Preferred Equipment Group 1

Sport Package	BYP	X
Silverado Decor	YE9	X
Air Conditioning	C60	X
Body: Sportside	E62	X
Convenience Group: Tilt-Wheel and Speed Control	ZQ3	X
Convenience Group: Power Door Locks and Windows	ZQ2	X
Lighting, Auxiliary	TR9	X
Radio: AM/FM Stereo w/Tape and Clock (A)	UM6	X

Allowable Substitutions (Where Available):
(A) UM6: May substitute UX1 Stereo Radio

Preferred Equipment Group Prices

	C10703
*2748.00	w/ZQ8
*3128.00	w/o ZQ8
*3308.00	K10703
**(-700.00)	PEG SAVINGS

*The Preferred Equipment Group MSRP's Reflect the Basic Group Equipment Prices. For any Option Additions, Upgrades, or Substitutions, Refer to the Vehicle Price Schedule for any Price Differential.
** PEG Savings Amount represents the savings for Preferred Equipment Groups.

ADDITIONAL OPTIONS

PLEASE REVIEW OPTION RESTRICTIONS BEFORE ORDERING

INCL w/PEG	OPTION	
		ACKNOWLEDGEMENTS:
N.C.	R8S	Multiple Order Numbers
N.C.	R8T	Preliminary Invoice
N.C.	1 C60	AIR CONDITIONING: (Incls R134A Refrigerant)
		AXLES, REAR: (Refer Power Teams Chart for Availability)
N.C.	GU4	3.08 Ratio
N.C.	GU6	3.42 Ratio
N.C.	GT4	3.73 Ratio
252.00	G80	Locking Differential (N/A GU4 Axle)
134.00	TP2	BATTERY: Heavy-Duty, Auxiliary (K10703 Only) (Reqs L03 or L05 Eng)
N.C.	1 E62	BODY CODE: 6-1/2 Ft. Sportside
		CHASSIS EQUIPMENT:
270.00	Z71	Off-Road Chassis Package (K10703 Only) (N/A F51 Shocks) (Incls NZZ Skid Plate and Bilstein Shocks)
1065.00	ZQ8	Sport Handling Package (C10703 Only) (Reqs XCN Tires) (N/A F51 Shocks) (Incls Bilstein Gas Shocks and Chrome Wheels)
33.00	V10	COLD-CLIMATE PACKAGE: (Incls Eng Block Heater)
		CONVENIENCE GROUP:
N.C.	1 ZQ3	Tilt-Wheel and Speed Control
N.C.	1 ZQ2	Power Door Locks and Windows
		COOLING SYSTEM:
	KC4	Engine Oil (Reqs MM5 or MT8 Trans)
N.C.		w/Z82
135.00		w/o Z82
	V08	Engine and Transmission Oil (Reqs MX0 Transmission)
N.C.		w/Z82
135.00		w/o Z82
	KNP	Transmission, Heavy-Duty Auxiliary (Reqs L05 Eng and MX0 Trans) (N/A GU4 Axle)
		(Incl w/Z82 Trailering when L05 Eng, MX0 Trans and GT4 Axle are ordered)
N.C.		w/Z82
96.00		w/o Z82
		EMISSIONS: (Refer Emission Requirement Tab Section)
N.C.	FE9	Federal Emission Requirements
N.C.	NA6	High Altitude Emission Requirements
	NG1	New York State Emission Requirements
100.00		w/5600 GVWR
N.C.		Above 5600 GVWR
100.00	YF5	California Emission Requirements
N.C.	NB8	California or New York Emission Override (Reqs FE9 Federal or NA6 High Altitude Emissions)
N.C.	NC7	Federal or High Altitude Emission Override (Reqs NG1 New York State or YF5 California Emissions)
		ENGINES: (Refer Power Teams Chart for Availability)
N.C.	LB4	4.3 Liter (262 Cu In)--EFI V6
575.00	L03	5.0 Liter (305 Cu In)--EFI V8
865.00	L05	5.7 Liter (350 Cu In)--EFI V8
N.C.	VK3	LICENSE PLATE BRACKET: Front
N.C.	1 TR9	LIGHTING, AUXILIARY: (Incls Dome and Reading Lamps, Ashtray, Glovebox and Underhood Lamps)
N.C.	ZY1	PAINT, EXTERIOR: Solid (Refer Color/Trim Chart for Availability)
		RADIO EQUIPMENT: (Incls Fixed Mast Antenna)
N.C.	1 UM6	Electronically Tuned AM/FM Stereo Radio w/Seek-Scan, Stereo Cassette Tape and Digital Clock
150.00	UX1	Electronically Tuned AM Stereo/FM Stereo Radio w/Seek-Scan, Stereo Cassette Tape w/Search and Repeat, Graphic Equalizer and Digital Clock
40.00	F51	SHOCK ABSORBERS: Front and Rear, Heavy Duty (N/A Z71 Off-Road Chassis or ZQ8 Sport Chassis)
		SEAT TRIM: (Refer Color/Trim Chart for Availability)
N.C.	V**1	Vinyl Bench Seat
174.00	V**3	Vinyl Reclining Split Bench Seat
N.C.	L**1	Custom Cloth Bench Seat
174.00	L**3	Custom Cloth Reclining Split Bench Seat
490.00	L**6	Custom Cloth Reclining High Back Bucket Seats
	NZZ	SKID PLATE: Off-Road (K10703 Only) (Incls Engine Front Differential and Transfer Case Shield)
		(Incl w/Z71 Off-Road Chassis)
N.C.		w/Z71
95.00		w/o Z71

ADDITIONAL OPTIONS

PLEASE REVIEW OPTION RESTRICTIONS BEFORE ORDERING

INCL w/PEG	OPTION	
59.00	U16	TACHOMETER
		TIRES: (Refer Tire Chart for Availability and Vehicle Price Schedule for prices)
	Z82	TRAILERING SPECIAL EQUIPMENT: Heavy-Duty (Incls Trailer Hitch and Wiring Harness)(w/o Z71 or ZQ8 Chassis Incls F51 Shock Absorbers) (w/Z71or ZQ8 Chassis Incls Bilstein Shocks) (Incls KC4 or V08 Cooling) (w/LB4 Eng N/A GU4 Axle) (w/MT8 Trans. Reqs L05 Eng) (N/A MMS Trans) (w/L05 Eng, MX0 Trans and GT4 Axle incls KNP Trans Cooler)
345.00		w/Z71
385.00		w/o Z71
		TRANSMISSIONS: (Refer Power Teams Chart for Availability)
N.C.	MM5	5-Speed Manual with Overdrive
98.00	MT8	5-Speed Manual with Deep Low and Overdrive, Heavy-Duty
930.00	MX0	4-Speed Electronically Controlled Automatic with Overdrive
113.00	A28	WINDOW: Sliding Rear

**C/K1500 SPORT TRUCK PICKUP
INTERIOR AND EXTERIOR COLOR AVAILABILITY CHART
WITH ZY1 PAINT**

PLEASE NOTE: Below are the interior trim color and exterior paint combinations recommended by Chevrolet. They are the only available interior and exterior combinations allowed.

TRIM LEVEL Seat Type	Decor	INTERIOR COLORS		
		Beige	Garnet	Gray
SILVERADO	YE9			
Vinyl Bench Seat		VUU1	VRR1	VQQ1
Custom Cloth Bench Seat		LUU1	LRR1	LQQ1
Vinyl Reclining Split Bench Seat		VUU3	VRR3	VQQ3
Custom Cloth Reclining Split Bench Seat		LUU3	LRR3	LQQ3
Custom Cloth Reclining High Back Bucket Seats		LUU6	LRR6	LQQ6

EXTERIOR COLORS	Color Code 1	Color Code 2	INTERIOR & EXTERIOR COMBINATIONS SHOWN ARE THE ONLY COMBINATIONS AVAILABLE		
BLACK, ONYX	41	41	x	x	x
GREEN, TEAL (Met)	38	38	x		x
RED, VICTORY	74	74	x	x	x

SOLID PAINT -- ZY1

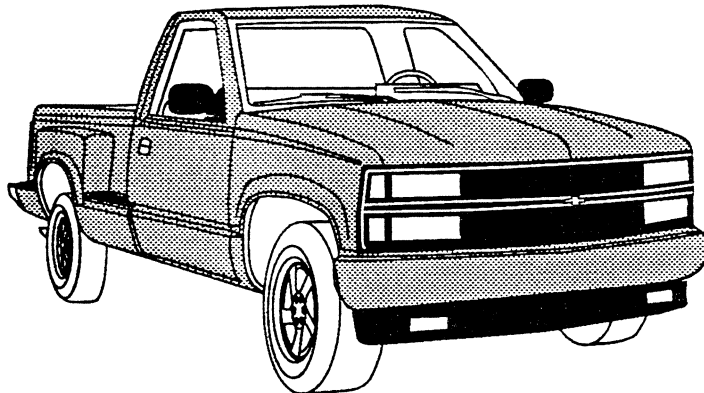

Available on C/K Pickup and Extended Cab Pickup Models Only

NO DELETIONS ALLOWED. Additional Options/Upgrades (Where Indicated)
May Be Ordered From The Custom Ordering Options in the
C/K Pickup and Extended Cab Order Guide Sections

		Silverado
		R V A 1
Upfitter Preferred Equipment Group 1		
Upfitter Package (Incls: Incomplete Vehicle Certification)	YF7	x
Air Conditioning	C60	x
Body, Fleetside (May Substitute E62 Sportside)	E63	x
Decor, Silverado	YE9	x
Lighting, Auxiliary	TR9	x
Mirrors, Stainless Steel (C)	D45	x
Power Windows/Door Locks (A)	ZQ2	x
Radio, AM/FM Stereo w/Tape and Clock (B)	UM6	x
Tilt Wheel/Speed Control	ZQ3	x
Temporary Seat	VK5	x

- (A) Incl w/C/K1500 Models Only
- (B) May substitute UX1 Radio
- (C) May substitute DF2 Mirror

MUST SPECIFY ONE OF THE FOLLOWING TRIMS:
(Incls Incomplete Vehicle Certification)

- VUU7 - Beige Temporary Seating
- VDD7 - Blue Temporary Seating
- VRR7 - Garnet Temporary Seating
- VTT7 - Gray Temporary Seating

ADDITIONAL CUSTOM ORDERING OPTIONS

Refer C/K 1500, 2500, 3500 Regular Cab and Extended Cab Pickup Order Guide Sections for Additional Options, Power Teams and Tire Availability Selections.

- (-31.00) BNP Wheel Opening Molding Delete (N/A K209*3 w/C6P or K309*3 or R05 Dual Rear Wheels)
- N.C. APC Seat Belt Provisions for Bucket Seats
- N.C. APD Seat Belt Provisions for Bench Seat

- 2,644.00 RVA1 With C/K 1500
- 2,277.00 RVA1 With C/K 2500, C/K 3500

SAVINGS

- (-900.00) 1500 REGULAR & EXTENDED
- (-700.00) 2500 REGULAR CAB
- (-900.00) 2500 EXTENDED CAB
- (-650.00) 3500 REGULAR CAB
- (-900.00) 3500 EXTENDED CAB

**NOTE: FOR INFORMATION PURPOSES ONLY
YF7 UPFITTER PACKAGE AVAILABLE FOR ORDERING THROUGH
AUTHORIZED C.Q.A.C.P. MANUFACTURERS ONLY**

**YF7 UPFITTER PACKAGE
C/K SUBURBAN**

**NO DELETIONS ALLOWED. Additional Options/Upgrades (Where Indicated)
May Be Ordered From The Additional Option Listing Below and
Custom Ordering Options in the Suburban Order Guide Section**

	R V A 1
Upfitter Preferred Equipment Group 1	
Upfitter Package	YF7
Air Conditioning	C60
Body, Standard (May Substitute E55 Tailgate)	ZW9
Decor, Silverado (A)	YE9
Door Locks and Windows, Power	ZQ2
Glass, Deep Tinted	AJ1
Radio AM/FM Cassette Tape w/Seek-Scan and Clock	UM6
Remote-Electric Outside Rearview Mirrors	D48
Tilt-Wheel and Speed Control	ZQ3

(A) Does not incl DK6 Roof Console or D55 Floor console w/ Bucket Seats

	RVA1
4,163.00	ZW9 & VK5
4,303.00	ZW9
4,099.00	E55 & VK5
4,239.00	E55

ADDITIONAL CUSTOM ORDERING OPTIONS

135.00	D55	Floor Console
	VK5	Front Seat Delete (Incls Incomplete Vehicle Certification)
(-635.00)	ATZ	Front and Second (Middle) Seats Delete (Reqs VK5)
578.00	AS3	Far Rear Seat (MUST Be Ordered If Desired)
50.00	DK6	Roof Console (Reqs Bucket Seats or VK5)
150.00	UX1	Electronically Tuned AM Stereo/FM Radio w/Seek-Scan, Stereo Cassette Tape w/Search and Repeat, Graphic Equalizer and Digital Clock
N.C.	APC	Seat Belt Provisions for Bucket Seats (Reqs VK5 Seat Delete)
N.C.	APD	Seat Belt Provisions for Bench Seat (Reqs VK5 Seat Delete)
(-31.00)	BNP	Wheel Opening Molding Delete (N/A K20906)

Refer C/K 1500 and C/K 2500 Suburban Order Guide Sections for Additional Options, Power Teams and Tire Availability, and Color/Trim Selections.

**NOTE: FOR INFORMATION PURPOSES ONLY
YF7 UPFITTER PACKAGE AVAILABLE FOR ORDERING THROUGH
AUTHORIZED C.Q.A.C.P. MANUFACTURERS ONLY**

MODELS

REGULAR CAB

Fleetside 2-wheel drive (CC20903)	3
Fleetside 4-wheel drive (CK20903)	3

EXTENDED CAB

Fleetside 2-wheel drive (CC20753)	6
Fleetside 2-wheel drive (CC20953)	6
Fleetside 4-wheel drive (CK20753)	6
Fleetside 4-wheel drive (CK20953)	6

DIMENSIONS

Wheelbase (inches)	
C-K20903	131.5
C-K20753	141.5
C-K20953	155.5
Cab-Axle (inches)	
C-K20903/C-K20953	55.9
C-K20753	41.8
Length (overall - inches)	
C-K20903	212.6
C-K20753	223.0
C-K20953	237.0
Width (overall-inches)	
C-K20903	76.8
C-K20753	76.4
Box Size Length (overall - inches)	
C-K20903/C-K20953	97.6
C-K20753	78.7
Box Depth (inches)	19.3
Payload (pounds)	
CC20903	3197
CK20903	2848
CC20753	2961
CK20753	2657
CC20953	2868
CK20953	2558
GVWR	7200
w/C6P	8600
Fuel Tank Capacity	
C-K20903/C-K20953	34 Gal.
C-K20753	25 Gal.

POWER TEAMS

Standard Engine

RPO LB4 4.3 Liter (262 Cu In) V6 with Electronic Fuel Injection (EFI)

Standard Transmission

RPO MM5 5-Speed Manual
RPO MT8 5-Speed Manual, H.D. w/C6P 8600 GVWR

STANDARD EQUIPMENT SUMMARY

EXTERIOR

Air Dam: Black (7200 GVW only)
 Battery: 600 Cold Cranking Amps
 Brakes: Power assisted front disc, rear drum. Rear wheel anti-lock
 Bumper: Chrome front
 Grille: Molded painted argent
 Headlamps: Single rectangular halogen
 Mirrors: RH and LH below-eye-line, painted black
 Nameplate: Cheyenne
 Radiator, Heavy Duty
 Tires:
 7200 GVW - LT225/75R16D All Seasons Steel Belted Radial Ply BW
 K20753 - LT245/75R16C
 8600 GVW - LT245/75R16E All Seasons Steel Belted Radial Ply BW
 Tow Hooks: Two front (K2500 models)
 Wheels: Silver painted with black hub ornament
 Wheel Opening Flares: K2500 models w/8600 GVW
 Windshield Wipers: Intermittent

INTERIOR

Cigarette Lighter
 Cupholders, Mounted Under Dash with Bench or 60/40 Seat(s). Located in Center Console with Bucket Seats
 Door Guard Beams: Side
 Dome Lamp: With switch in LH and RH door jamb
 Floor Covering: Color-keyed rubber mat
 Gages: Engine temperature, fuel level, odometer, oil pressure, speedometer, telltale lights, trip odometer and voltmeter
 Glass: Tinted, Solar-Ray, all windows
 Glove Box: Latched door and beverage holder
 Headliner: Color-keyed cloth with matching retainer molding
 Heater: Deluxe heater with windshield and side window defoggers
 Mirror: 10-inch rearview
 Radio: Electronically-tuned AM radio with fixed mast antenna
 Scotchgard Fabric Protector on cloth trim and door panels
 Seats:
Regular Cab: 3-passenger all-vinyl trim front bench seat with head restraints and folding backrest. Optional bucket seats also include console
Extended Cab: 60/40 Vinyl reclining split bench seats with driver and passenger easy entry feature
 Steering Wheel: Custom urethane 4-spoke
 Stop Lamp: Center-mounted with cargo area lamp
 Sunshades: Color-keyed cloth RH and LH padded

OPTIONAL UPLEVEL DECOR
SILVERADO DECOR LEVEL (RPO YE9)

The following equipment is in addition to or replacing items included in the Cheyenne decor

EXTERIOR

- Bumper: Chrome front bumper includes a black rub strip with bright trim
- Grille: Deluxe front appearance package with dark argent grille and bright trim
- Headlamps: Dual composite halogen
- Horn: Dual low and high note electric
- Moldings: Black body side moldings with bright trim and bright wheel opening moldings (K2500 models w/8600 GVW include body side moldings only)
- Nameplate: Silverado
- Wheels: Rally wheel trim
- Windows: Swing out quarter (C-K20*53 Only)

INTERIOR

- Floor Covering: Color-keyed carpeting
- Floor Mats: Front removable color-keyed rubber (C-K20*53 also includes rear mat)
- Radio: Electronically tuned AM/FM stereo w/seek-scan and digital clock
- Seats: Regular Cab: 3-passenger with choice of custom vinyl or custom cloth front bench seat with folding backrest. Optional bucket seats include console
- Extended Cab: Vinyl reclining 60/40 split bench seat with easy entry feature
- Steering Wheel, Sport
- Storage Tray: Full width strap behind seat on floor
- Sunshades: Cloth covered with storage strap on LH unit and visor mirror on RH unit

MODEL AND BODY

Description	Model No	Body
2-WHEEL-DRIVE MODEL		
*15,514.00 Fleetside	CC20903	E63
*17,182.68 Fleetside	CC20903	E63 & C6P
*18,242.00 Fleetside, Ext Cab	CC20753	E63
*18,929.68 Fleetside, Ext Cab	CC20953	E63 & C6P

Description	Model No	Body
4-WHEEL-DRIVE MODEL		
*17,543.00 Fleetside	CK20903	E63
*19,634.68 Fleetside	CK20903	E63 & C6P
*20,059.24 Fleetside, Ext Cab	CK20753	E63
*21,401.68 Fleetside, Ext Cab	CK20953	E63 & C6P

*Includes Destination & Handling Charges

EMISSIONS (Must Specify One) (Refer Emission Requirements Section)

- FE9 Federal Emission Requirements (Satisfies High Altitude Requirements at 8600 GVWR)
- NA6 High Altitude Emission Requirements (Not Required at 8600 GVWR)
- NG1 New York State Emission Requirements
- YF5 California Emission Requirements
- NB8 California or New York State Emission Override (Reqs FE9 Federal or NA6 High Altitude Emissions)
- NC7 Federal or High Altitude Emission Override (Reqs NG1 New York State or YF5 California Emissions)

*** GVWR SELECTOR**

Minimum Equipment Required for GVW Rating

GVW Rating (lbs)	GAWR*		
	Front	Rear	
C20903			
7200	3150	4670	Reqs LB4, L03 or L05 Eng
7200	3400	4670	Reqs L49 or L56 Eng
8600	3600	6000	Reqs C6P & YHH or YGK; N/A MM5 Trans, LB4, L03, L49 or L56 Eng
K20903			
7200	3750	4670	Reqs LB4, L03 or L05 Eng ; N/A XHH or XGK
7200	3750	4800	Reqs XHH or XGK Tires; N/A L19 or L65 Eng
8600	3750	6000	Reqs C6P & YHH or YGK; N/A MM5 Trans, LB4, L03, L49 or L56 Eng
C20753			
7200	3600	4670	N/A L19 or L65 Eng
K20753			
7200	3750	4410	N/A L19 or L65 Eng
C20953			
8600	3600	6000	Reqs C6P & YHH or YGK
K20953			
8600	3750	6000	Reqs C6P & YHH or YGK

*GAWR's shown are the minimum for each axle with equipment listed. Other GAWR's are available, and they are determined as the minimum capacity of either axle, springs or tires.

POWER TEAMS (Must Specify Engine, Transmission and Rear Axle)

(Consult GVWR Selector For Minimum Equipment Required)

ENGINE	TRANSMISSION		AXLE				GVWR
	5-SP	AUTO	3.42	3.73	4.10	4.56	
CC20903							
LB4 V6 4.3 Liter (262 Cu In)--EFI	MM5/MT8		(a) GU6	(a) GT4	--	--	7200
		MX0	(a) GU6	(a) GT4	(a) GT5	--	7200
L03 V8 5.0 Liter (305 Cu In)--EFI	MM5		(a) GU6	(a) GT4	--	--	7200
		MX0	(b) GU6	(b) GT4	(a) GT5	--	7200
L05 V8 5.7 Liter (350 Cu In)--EFI	MM5		GU6	GT4	--	--	7200
	MT8		(c) GU6	(c) GT4	--	--	7200
		MX0	GU6	GT4	GT5	--	7200
L05 V8 5.7 Liter H. D. (350 Cu In)--EFI (Reqs C6P)	MT8		(b) GU6	(b) GT4	(b) GT5	--	8600
		MX0	--	(b) GT4	(b) GT5	(a) HC4	8600
L19 V8 7.4 Liter (454 Cu In)-EFI	MT8		(a) GU6	(a) GT4	(a) GT5	--	8600
		MX0	--	(b) GT4	(b) GT5	--	8600
L49 Diesel 6.5 Liter V8 (400 Cu In)	MT8	MX0	(a) GU6	(a) GT4	--	--	7200
L56 Turbo Diesel 6.5 Liter V8 (400 Cu In)		MX0	(a) GU6	(a) GT4	--	--	7200
L65 Turbo Diesel 6.5 Liter V8 (400 Cu In)	MT8	MX0	(b) GU6	(b) GT4	(b) GT5	--	8600
CK20903							
LB4 V6 4.3 Liter (262 Cu In)--EFI	MM5/MT8	MX0	--	(a) GT4	--	--	7200
L03 V8 5.0 Liter (305 Cu In)--EFI	MM5		(c) GU6	(c) GT4	--	--	7200
		MX0	GU6	(c) GT4	--	--	7200
L05 V8 5.7 Liter (350 Cu In)--EFI	MM5		GU6	GT4	--	--	7200
	MT8		(c) GU6	(c) GT4	--	--	7200
		MX0	GU6	GT4	GT5	--	7200
L05 V8 5.7 Liter H.D. (350 Cu In)--EFI (Reqs C6P)	MT8		(b) GU6	(b) GT4	(b) GT5	--	8600
		MX0	--	--	(b) GT5	(a) HC4	8600
L19 V8 7.4 Liter (454 Cu In)-EFI	MT8		(b) GU6	(b) GT4	(b) GT5	--	8600
		MX0	--	(b) GT4	(b) GT5	--	8600
L49 Diesel 6.5 Liter V8 (400 Cu In)	MT8	MX0	(a) GU6	(a) GT4	--	--	7200
L56 Turbo Diesel 6.5 Liter V8 (400 Cu In)		MX0	(a) GU6	(a) GT4	--	--	7200
L65 Turbo Diesel 6.5 Liter V8 (400 Cu In)	MT8	MX0	(b) GU6	(b) GT4	(b) GT5	--	8600

(a) Reqs FE9 Federal or NG1 New York State Emissions
 (b) N/A NA6 High Altitude Emission
 (c) N/A YF5 California Emission

CONTINUED ON PAGE 5

POWER TEAMS (Continued)

(Consult GVWR Selector For Minimum Equipment Required)

ENGINE	TRANSMISSION		AXLE				GVWR
	5-SP	AUTO	3.42	3.73	4.10	4.56	
CC20753							
L03 V8 5.0 Liter (305 Cu In)--EFI	MM5		(b) GU6	--	--	--	7200
		MX0	(b) GU6	(b) GT4	--	--	7200
L05 V8 5.7 Liter (350 Cu In)--EFI	MM5		(b) GU6	(b) GT4	--	--	7200
	MT8		(b) GU6	(a) GT4	--	--	7200
		MX0	(c) GU6	GT4	GT5	--	7200
L49 Diesel V8 6.5 Liter (400 Cu In)	MT8	MX0	(b) GU6	(b) GT4	--	--	7200
L56 Turbo Diesel V8 6.5 Liter (400 Cu In)		MX0	(b) GU6	(b) GT4	--	--	7200
CC20953							
L05 V8 5.7 Liter H.D. (350 Cu In)--EFI	MT8		(b) GU6	(b) GT4	(b) GT5	--	8600
		MX0	--	(c) GT4	(c) GT5	(b) HC4	8600
L19 V8 7.4 Liter (454 Cu In)-EFI	MT8		(b) GU6	(b) GT4	(b) GT5	--	8600
		MX0	--	(c) GT4	(c) GT5	--	8600
L65 Turbo Diesel 6.5 Liter V8 (400 Cu In)	MT8	MX0	(c) GU6	(c) GT4	(c) GT5	--	8600
CK20753							
L03 V8 5.0 Liter (305 Cu In)--EFI	MM5	MX0	(b) GU6	(b) GT4	--	--	7200
L05 V8 5.7 Liter (350 Cu In)--EFI	MM5/MT8		(a) GU6	(a) GT4	--	--	7200
		MX0	GU6	GT4	GT5	--	7200
L49 Diesel V8 6.5 Liter (400 Cu In)	MT8	MX0	(b) GU6	(b) GT4	--	--	7200
L56 Turbo Diesel V8 6.5 Liter (400 Cu In)		MX0	(b) GU6	(b) GT4	--	--	7200
CK20953							
L05 V8 5.7 Liter H.D. (350 Cu In)--EFI	MT8		(b) GU6	(b) GT4	(b) GT5	--	8600
		MX0	--	--	(c) GT5	(b) HC4	8600
L19 V8 7.4 Liter (454 Cu In) -EFI	MT8		(b) GU6	(c) GT4	(c) GT5	--	8600
		MX0	--	(c) GT4	(c) GT5	--	8600
L65 Turbo Diesel 6.5 Liter V8 (400 Cu In)	MT8	MX0	(c) GU6	(c) GT4	(c) GT5	--	8600

(a) N/A YF5 California Emission

(b) Reqs FE9 Federal or NG1 New York State Emissions

(c) N/A NA6 High Altitude Emission. W/8600 GVWR, FE9 Satisfies High Altitude Requirements

CAPACITIES

C20903

SPRINGS:	AXLES:
Front	Front
3150 Base	3150 Base
3400 w/Diesel Eng	3400 w/Diesel Eng
3600 w/C6P	3800 w/C6P

Rear	Rear
4800 Base	4800 Base
6084 w/C6P	6000 w/C6P

C20753-C20953

SPRINGS:	AXLES:
Front	Front
3600 Base	3600 Base
3800 w/C6P	3800 w/C6P

Rear	Rear
4800 Base	4800 Base
6084 w/C6P	6000 w/C6P

K20903

SPRINGS:	AXLES:
Front	Front
3750 Base	3925 Base
	4250 w/C6P

Rear	Rear
4800 Base	4800 Base
6084 w/C6P	6000 w/C6P

K20753-K20953

SPRINGS:	AXLES:
Front	Front
3750 Base	3925 Base
3925 w/C6P	4250 w/C6P

Rear	Rear
4800 Base	4800 Base
6084 w/C6P	6000 w/C6P

TIRES (Must Specify Front and Rear Tire) (Spare Tire is Optional and Includes Tire Carrier)

Description	Highway		On-Off Road		Spare
	Front	Rear	Front	Rear	
C20903					
TUBELESS Steel Belted Radial					
(b) LT225/75R16-D B/W	XHP	YHP			ZHP
(b) LT225/75R16-D B/W	XHP			YHR	ZHR
LT245/75R16-E B/W	XHH	YHH			ZHH
LT245/75R16-E B/W	XHH			YGK	ZGK
K20903					
TUBELESS Steel Belted Radial					
(b) LT225/75R16-D B/W	XHP	YHP			ZHP
(b) LT225/75R16-D B/W			XHR	YHR	ZHR
LT245/75R16-E B/W			XGK	YGK	ZGK
LT245/75R16-E B/W	XHH	YHH			ZHH
C20753-C20953					
TUBELESS Steel Belted Radial					
(b) LT225/75R16-D B/W	XHP	YHP			ZHP
(b) LT225/75R16-D B/W	XHP			YHR	ZHR
LT245/75R16-E B/W	XHH	YHH			ZHH
LT245/75R16-E B/W	XHH			YGK	ZGK
K20753-K20953					
TUBELESS Steel Belted Radial					
LT245/75R16-C B/W	XBK	YBK			ZBK
LT245/75R16-C B/W			XBN	YBN	ZBN
LT245/75R16-C WOL			XBX	YBX	ZBX
(a) LT245/75R16-E B/W			XGK	YGK	ZGK
(a) LT245/75R16-E B/W	XHH	YHH			ZHH

(a) Available K20953 w/C6P 8600 GVWR Only
 (b) N/A C6P 8600 GVWR

WOL = White Outlined Letter
 B/W = Blackwall

MUST SPECIFY:

AXLE, EMISSION, ENGINE, TIRES AND TRANSMISSION

No Deletions Allowed, Additional Options/Upgrades (Where Indicated)
 May be Ordered from the Custom Ordering Option Listing

		CHEYENNE		SILVERADO	
		P 2 A 1	P 2 A 2	P 2 A 3	P 2 A 4
Preferred Equipment Group 1					
Body: Fleetside	E63	x	x	x	x
Preferred Equipment Group 2					
Air Conditioning	C60		x	x	x
Radio: AM/FM Stereo w/Clock (A)	UM7		x	x	N/I
Preferred Equipment Group 3					
Silverado Decor	YE9			x	x
Lighting, Auxiliary	TR9			x	x
Mirrors: Below-Eye-Line, Stainless Steel (B)	D45			x	x
Preferred Equipment Group 4					
Convenience Group: Tilt-Wheel and Speed Control	ZQ3				x
Convenience Group: Power Locks and Windows	ZQ2				x
Radio: AM/FM Stereo w/Tape and Clock (C)	UM6				x

Allowable Substitutions (Where Available):

- (A) UM7: May substitute UM6 or UX1 Stereo Radio
- (B) D45: May substitute DF2 Mirrors or Z81 Camper Special
- (C) UM6: May substitute UX1 Stereo Radio

Preferred Equipment Group Prices

N/C	P2A1
*975.00	P2A2
**(-400.00)	PEG 2 SAVINGS

Preferred Equipment Group Prices

*1912.00	P2A3
**(-500.00)	PEG 3 SAVINGS
**(-600.00)	REGULAR CAB
	EXTENDED CAB
*2784.00	P2A4
**(-600.00)	PEG 4 SAVINGS
**(-700.00)	REGULAR CAB
	EXTENDED CAB

*The Preferred Equipment Group MSRPs Reflect the Basic Group Equipment Prices. For any Option Additions,Upgrades or Substitutions, Refer to the Vehicle Price Schedule for any Price Differential.
 **PEG Savings Amount represents the savings for Preferred Equipment Groups.

ADDITIONAL OPTIONS

INCL w/PEG	OPTION	
		ACKNOWLEDGEMENTS:
N.C.	R8S	Multiple Order Numbers
N.C.	R8T	Preliminary Invoice
2,3,4	C60	AIR CONDITIONING: (Incls R134A Refrigerant) w/P2A2, P2A3 or P2A4 w/P2A1
805.00	V22	APPEARANCE PACKAGE: (Incls Chrome Grille, Composite Halogen Headlamps and Dual Horns) (Incl w/Silverado Decor) w/P2A3 or P2A4 w/P2A1 or P2A2
N.C.		AXLES, REAR: (Refer Power Teams Chart for Availability)
191.00	GU6	3.42 Ratio
N.C.	GT4	3.73 Ratio
N.C.	GT5	4.10 Ratio w/C6P w/o C6P
135.00	HC4	4.56 Ratio w/C6P w/o C6P
N.C.	G80	Locking Differential
135.00	TP2	BATTERY: Heavy-Duty, Auxiliary (N/A LB4 Eng w/o Z81 Camper or Diesel Eng) (Incl w/Z81 Camper Special) w/Z81 w/o Z81
252.00	BZY	BEDLINER: Under Rail (N/A P13 Wheel Carrier)
N.C.	E63	BODY: Fleetside
134.00		BUMPER EQUIPMENT:
225.00	VB3	Bumper, Chromed. Rear Step w/Rub Strip
N.C.	VG3	Bumper, Chromed. Front Deluxe w/Rub Strip (Incl w/Silverado Decor) w/P2A3 or P2A4 w/P2A1 or P2A2
26.00	V43	Bumper, Painted. Rear Step
130.00	V27	Bumper Guards, Front. Black (Reqs VG3 Bumper or Silverado Decor) (Incl w/Diesel Eng w/Silverado Decor) w/Diesel Eng w/o Diesel Eng
N.C.	Z81	CAMPER SPECIAL CHASSIS EQUIPMENT: Basic Camper Group (Incls DF2 Camper Type Stainless Steel Mirrors and Camper Wiring Harness)(Also incls TP2 Auxiliary Battery w/o Diesel Eng) (w/o GT5 or HC4 Axle or L19 or Diesel Eng, Reqs KC4 or V08 Cooling) (N/A D45 Mirrors) w/Diesel Eng and P2A3 or P2A4 w/o Diesel Eng and P2A3 or P2A4 w/Diesel Eng and P2A1 or P2A2 w/o Diesel Eng and P2A1 or P2A2
32.00	P13	CARRIER, SPARE WHEEL AND TIRE: Side Mounted (N/A BZY Bedliner or C-K20753)
54.00	V10	COLD-CLIMATE PACKAGE: (N/A Diesel Eng) (Incls Eng Block Heater)
188.00		CONVENIENCE GROUP:
99.00	4	ZQ2 Power Door Locks and Windows w/P2A4 w/o P2A4
233.00	4	ZQ3 Tilt-Wheel and Speed Control w/P2A4 w/o P2A4
N.C.		COOLING SYSTEM: (Incl w/Z82 Trailering Where Available)
33.00	KC4	Engine Oil (Reqs MM5 or MT8 Trans) (N/A L19 or Diesel Eng or GT5/HC4 Axle)
135.00	V08	Engine and Transmission Oil (Reqs MX0 Trans) (N/A L19 or Diesel Eng or GT5/HC4 Axle)
135.00	KNP	Transmission, Heavy-Duty Auxiliary (Reqs MX0 Trans) (N/A L03 Eng) (Incl w/Z82 Trailering when L05 Eng and MX0 Trans w/o C6P are ordered) w/Z82 or C6P w/o Z82 or C6P
N.C.	C49	DEFOGGER: Electric Rear Window (Reqs Silverado Decor) (N/A A28 Window or C-K20903)
96.00		
154.00		

ADDITIONAL OPTIONS

INCL w/PEG	OPTION	
		EMISSIONS: (Refer Emission Requirement Tab Section)
N.C.	FE9	Federal Emission Requirements
N.C.	NA6	High Altitude Emission Requirements
N.C.	NG1	New York State Emission Requirements
	YF5	California Emission Requirements
N.C.		w/C6P
100.00		w/o C6P
N.C.	NB8	California or New York State Emission Override (Reqs FE9 Federal or NA6 High Altitude Emissions)
N.C.	NC7	Federal or High Altitude Emission Override (Reqs NG1 New York State or YF5 California Emissions)
		ENGINES: (Refer Power Teams Chart for Availability)
N.C.	LB4	4.3 Liter V6 (262 Cu In) EFI
	L03	5.0 Liter V8 (305 Cu In) EFI
N.C.		w/C-K20753
575.00		w/C-K20903 w/o C6P
	L05	5.7 Liter V8 (350 Cu In) EFI
N.C.		w/C6P
290.00		w/C-K20753 w/o C6P
865.00		w/C-K20903 w/o C6P
605.00	L19	7.4 Liter V8 (454 Cu In) EFI
	L49	6.5 Liter V8 Diesel (400 Cu In) (Naturally Aspirated) (Incls V27 Bumper w/Silverado Decor)
2295.00		w/C-K20753
2870.00		w/C-K20903
	L56	6.5 Liter V8 Turbo Diesel (400 Cu In) (Incls V27 Bumper w/Silverado Decor)
3095.00		w/C-K20753
3670.00		w/C-K20903
2825.00	L65	6.5 Liter V8 Turbo Diesel (400 Cu In) (Incls V27 Bumper w/Silverado Decor)
125.00	KL5	Alternative Fuel (LPG or CNG Conversion Ready) (Reqs L05 Eng and MX0 Trans) (C209*3 w/C6P Reqs GT4/GT5 Axle) (K20903 w/C6P Reqs HC4 Axle) (K20953 Reqs GT5 Axle) (N/A C/K20753)
	BG9	FLOOR COVERING: Full Floor, Rubber, Color-Keyed (Replaces Carpeting and Floor Mats)
		(Reqs Silverado Decor)
(-20.00)		w/C-K20*03
(-36.00)		w/C-K20*53
	AJ1	GLASS: Deep Tinted Solar-Ray (Incls A20 Swing-Out Windows) (When A28 Window or C49 Defogger is Specified Rear Window is Light Tint Glass) (N/A C-K20903)
72.00		w/P2A3 or P2A4 and A28 or C49
107.00		w/P2A3 or P2A4 w/o A28 or C49
115.00		w/P2A1 or P2A2 and A28 or C49
150.00		w/P2A1 or P2A2 w/o A28 or C49
N.C.	C6P	GVWR: 8600# (Refer GVWR Selector Chart)
		LAMPS:
	C95	Dome and Reading (Incl w/TR9 Lighting)
N.C.		w/TR9
33.00		w/o TR9
52.00	U01	Roof Marker (N/A YF5 Calif Emissions)
N.C.	VK3	LICENSE PLATE BRACKET: Front
	3,4	TR9 LIGHTING, AUXILIARY: (Incls C95 Dome and Reading Lamps, Ashtray, Glovebox and Underhood Lamps)
N.C.		w/P2A3 or P2A4
94.00		w/P2A1 or P2A2
		MIRRORS, EXTERIOR:
	3,4	D45 Below-Eye-Line Type, Stainless Steel (N/A Z81 Camper Special)
N.C.		w/P2A3 or P2A4
45.00		w/P2A1 or P2A2
	DF2	Camper Type, Stainless Steel (Incl w/Z81 Camper Special)
N.C.		w/Z81
8.00		w/P2A3 or P2A4
53.00		w/P2A1 or P2A2
	B85	MOLDING: Exterior, Bright (Incl w/Silverado Decor) (Incls Body Side and Wheel Opening) (K2500 w/C6P Incls Body Side Mldg Only)
N.C.		w/P2A3 or P2A4
76.00		K2500 w/C6P
107.00		K2500 w/o C6P or C2500
		PAINT, EXTERIOR: (Refer Color and Trim Chart for Availability)
N.C.	ZY1	Solid
132.00	ZY2	Conventional Two-Tone
243.00	ZY4	Deluxe Two-Tone

ADDITIONAL OPTIONS

INCL w/PEG	OPTION	
		RADIO EQUIPMENT: (Electronically Tuned AM Radio Standard)
	2,3 UM7	Electronically Tuned AM/FM Stereo Radio w/Seek-Scan and Digital Clock (Incl w/Silverado Decor) (N/A PEG P2A4) w/P2A2 or P2A3 w/P2A1
N.C. 170.00		
	4 UM6	Electronically Tuned AM/FM Stereo Radio w/Seek-Scan, Stereo Cassette Tape and Digital Clock w/P2A4 w/P2A2 or P2A3 w/P2A1
N.C. 122.00 292.00		
	UX1	Electronically Tuned AM Stereo/FM Stereo Radio w/Seek-Scan, Stereo Cassette Tape w/Search and Repeat, Graphic Equalizer and Digital Clock w/P2A4 w/P2A2 or P2A3 w/P2A1
150.00 272.00 442.00 (-117.00)		
240.00 (-395.00)	UL5	Radio Delete (Reqs P2A1)
	AG9	SEAT: Power Driver's Seat (Reqs Silverado Decor and Split Bench or Bucket Seats)(N/A C-K 20903)
	YG4	SEAT DELETE: Rear (Reqs Cheyenne Decor) (N/A C-K20903)
		SEAT TRIM: (Refer Color/Trim Chart for Availability)
N.C.	V**1	Vinyl Bench Seat
N.C.	C**1	Cloth Bench Seat
115.00 289.00	V**2	Vinyl Reclining Low Back Bucket Seat w/C-K20*53 w/C-K20*03
115.00 289.00	C**2	Cloth Reclining Low Back Bucket Seat w/C-K20*53 w/C-K20*03
N.C. 174.00	V**3	Vinyl Reclining Split Bench Seat w/C-K20*53 w/C-K20*03
N.C. 174.00	C**3	Cloth Reclining Split Bench Seat w/C-K20*53 w/C-K20*03
N.C.	L**1	Custom Cloth Bench Seat (N/A Ext Cab)
N.C. 174.00	L**3	Custom Cloth Reclining Split Bench Seat w/C-K20*53 w/C-K20*03
291.00 490.00	L**6	Custom Cloth Reclining High Back Bucket Seats w/C-K20*53 w/C-K20*03
95.00 118.00	NZZ	SKID PLATE: Off-Road (K2500 Only) (Incls Engine Front Differential and Transfer Case Shield)
	VYU	SNOW PLOW PREP PACKAGE: (K20903 Only) (N/A L49 or L56 Eng) (w/LB4, L03, L05 Eng and GU6/GT4 Axle Reqs KC4 or V08 Cooling)(Incls F60 H.D. Front Springs)
	F60	SPRINGS, FRONT: Heavy Duty (K2500 Only) (N/A L49 or L56 Eng) (Incl w/VYU Snow Plow Prep) w/VYU w/o VYU
N.C. 63.00 59.00	U16	TACHOMETER
38.00	V76	TIRES: (Refer Tire Chart for Availability; Vehicle Price Schedule for Prices)
	Z82	TOW HOOKS: Two Front (Standard on K2500 Models)
		TRAILERING SPECIAL EQUIPMENT: Heavy-Duty (Incls Trailer Hitch and Wiring Harness) C-K209*3: (Reqs VB3 or V43 Bumper) (N/A MM5 Trans) (w/LB4, L03, L05 Eng and GU6/GT4 Axle Incls KC4 or V08 Cooling) C20753: (w/L05 Eng and MT8 Trans Reqs GU6 Axle) (w/L49 Eng and MT8 Trans Reqs GT4 Axle) K20753: (w/L03 Reqs MX0 Trans) (w/L49 Eng and MT8 Trans Reqs GT4 Axle) C-K20903: (w/LB4 or L03 Eng Reqs MX0 Trans) (w/L49 Eng and MT8 Trans Reqs GT4 Axle) (w/L05 Eng and MX0 Trans w/o C6P 8600 GVWR or GU6 Axle Incls KNP Trans Cooler) w/Diesel or L19 or GT5 or HC4 w/o Diesel or L19 or GT5 or HC4
210.00 345.00		
N.C.	MM5	TRANSMISSIONS: (Refer Power Teams Chart for Availability) 5-Speed Manual with Overdrive
N.C. 98.00 930.00	MT8	5-Speed Manual with Deep Low and Overdrive. Heavy -Duty w/C6P or Diesel Eng w/o C6P or Diesel Eng
42.00	MX0	4-Speed Electronically Controlled Automatic with Overdrive
		WHEEL TRIM:
	P01	Wheel Covers (N/A Silverado Decor)
N.C. 60.00	P06	Rally Wheel Trim (Incl w/Silverado Decor) w/P2A3 or P2A4 w/P2A1 or P2A2
		WINDOWS:
113.00	A28	Sliding Rear (N/A C49 Defogger)
N.C. 43.00	A20	Swing-Out Quarter (Incl w/AJ1 Glass or Silverado Decor) (N/A C-K20903) w/P2A3 or P2A4 or AJ1 w/P2A1 or P2A2 w/o AJ1

**C/K 2500 PICKUP
PAINT APPLICATIONS
WITH ZY1, ZY2 AND ZY4 PAINT SCHEMES**

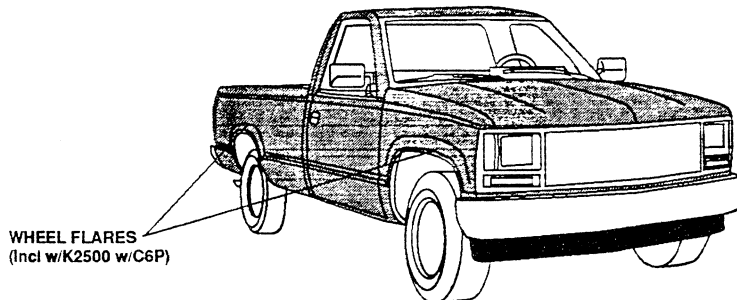

SOLID PAINT - ZY1

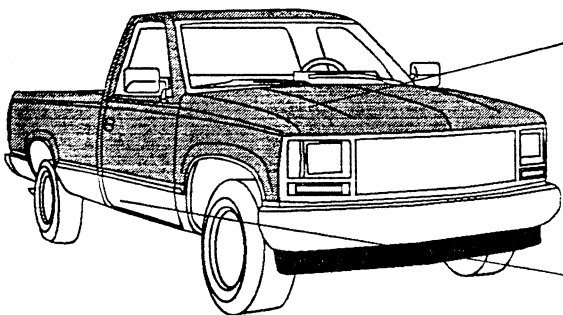

CONVENTIONAL TWO-TONE PAINT - ZY2

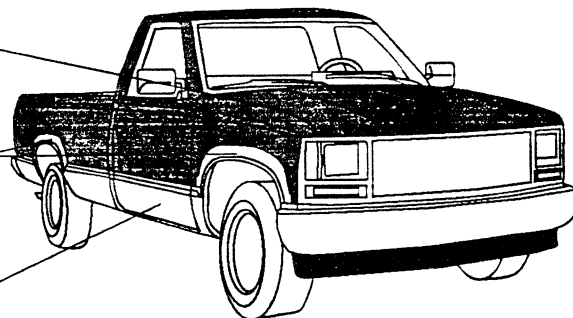

**CONVENTIONAL TWO-TONE PAINT - ZY2
K2500 w/C6P**

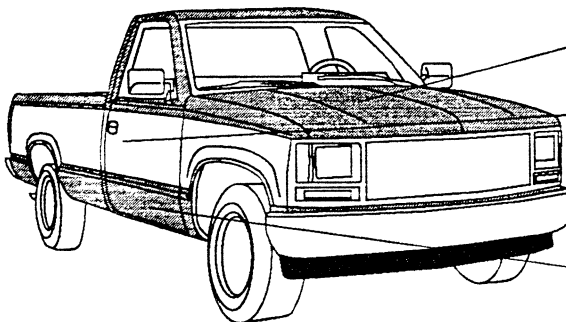

**DELUXE TWO-TONE PAINT - ZY4
(Includes Body Striping)**

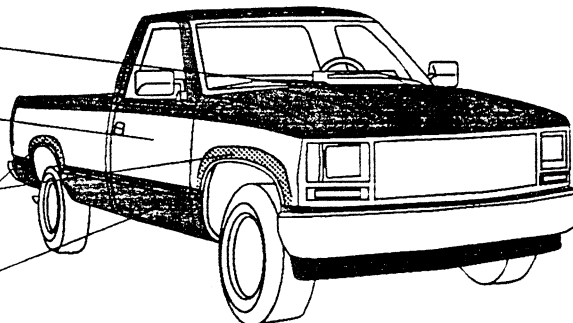

**DELUXE TWO-TONE PAINT - ZY4
(Includes Body Striping)
K2500 w/C6P**

C/K 2500 PICKUP INTERIOR AND EXTERIOR COLOR AVAILABILITY CHART WITH ZY1 AND ZY2 PAINT SCHEMES

PLEASE NOTE: Below are the interior trim color and exterior paint combinations recommended by Chevrolet. They are the only available interior and exterior combinations allowed.

TRIM LEVEL Seat Type	Decor	INTERIOR COLORS					
		Beige	Blue	Garnet	Gray		
CHEYENNE	Std						
Vinyl Bench Seat (N/A Extended Cab)		VUU1	VDD1	VRR1	VQQ1		
Cloth Bench Seat (N/A Extended Cab)		CUU1	CDD1	CRR1	CQQ1		
Vinyl Reclining Low Back Bkt Seat		VUU2	VDD2	VRR2	VQQ2		
Cloth Reclining Low Back Bkt Seat		CUU2	CDD2	CRR2	CQQ2		
Vinyl Reclining Split Bench Seat		VUU3	VDD3	VRR3	VQQ3		
Cloth Reclining Split Bench Seat		CUU3	CDD3	CRR3	CQQ3		
SILVERADO	YE9						
Vinyl Bench Seat (N/A Extended Cab)		VUU1	VDD1	VRR1	VQQ1		
Custom Cloth Bench Seat (N/A Extended Cab)		LUU1	LDD1	LRR1	LQQ1		
Vinyl Reclining Low Back Bkt Seat		VUU2	VDD2	VRR2	VQQ2		
Vinyl Reclining Split Bench Seat		VUU3	VDD3	VRR3	VQQ3		
Custom Cloth Reclining Split Bench Seat		LUU3	LDD3	LRR3	LQQ3		
Custom Cloth Reclining High Back Bucket Seats		LUU6	LDD6	LRR6	LQQ6		
EXTERIOR COLORS	Color Code 1	Color Code 2	INTERIOR & EXTERIOR COMBINATIONS SHOWN ARE THE ONLY COMBINATIONS AVAILABLE				K2500 w/C6P WHEEL FLARE COLOR
AUTUMNWOOD, DARK (Met)	56	56	x				Argent
Autumnwood, Lt (Met)	56	55	x				Autumnwood
AUTUMNWOOD, LT (Met)	55	55	x				Autumnwood
* Autumnwood, Dk (Met)	55	56	x				N/A
BLACK, ONYX	41	41	x		x	x	Black
Autumnwood, Lt (Met)	41	55	x				Autumnwood
Quicksilver (Met)	41	96			x	x	Silver
BLUE, INDIGO(Met)	39	39	x	x		x	Blue
Autumnwood, Lt (Met)	39	55	x	x			Autumnwood
* Blue, Lt Quasar (Met)	39	20		x		x	N/A
Quicksilver (Met)	39	96		x		x	Silver
BLUE, LT QUASAR (Met)	20	20		x		x	Argent
Blue, Indigo (Met)	20	39		x		x	Blue
Quicksilver (Met)	20	96		x		x	Silver
GREEN, TEAL (Met)	38	38	x			x	Argent
Quicksilver (Met)	38	96				x	Silver
QUICKSILVER (Met)	96	96		x	x	x	Silver
Black, Onyx	96	41			x	x	Black
Blue, Indigo (Met)	96	39		x		x	Blue
* Blue, Lt Quasar (Met)	96	20		x			N/A
* Green, Teal (Met)	96	38				x	N/A
Red, Dk Garnet (Met)	96	84			x	x	Dk Red
RED, DK GARNET (Met)	84	84	x		x	x	Dk Red
Quicksilver (Met)	84	96			x	x	Silver
RED, VICTORY	74	74	x		x	x	Argent
Black, Onyx	74	41	x		x	x	Black
Quicksilver (Met)	74	96			x	x	Silver
WHITE, SUMMIT	50	50	x	x	x	x	Argent

* N/A C6P on K2500

C/K 2500 PICKUP

INTERIOR AND EXTERIOR COLOR AVAILABILITY CHART WITH ZY4 PAINT SCHEMES

PLEASE NOTE: Below are the interior trim color and exterior paint combinations recommended by Chevrolet. They are the only available interior and exterior combinations allowed.

TRIM LEVEL		Decor	INTERIOR COLORS				STRIPE COLOR	K2500 w/C6P WHEEL FLARE COLOR
Seat Type			Beige	Blue	Garnet	Gray		
CHEYENNE		Std						
Vinyl Bench Seat (N/A Extended Cab)			VUU1	VDD1	VRR1	VQQ1		
Cloth Bench Seat (N/A Extended Cab)			CUU1	CDD1	CRR1	CQQ1		
Vinyl Reclining Low Back Bkt Seat			VUU2	VDD2	VRR2	VQQ2		
Cloth Reclining Low Back Bkt Seat			CUU2	CDD2	CRR2	CQQ2		
Vinyl Reclining Split Bench Seat			VUU3	VDD3	VRR3	VQQ3		
Cloth Reclining Split Bench Seat		CUU3	CDD3	CRR3	CQQ3			
SILVERADO		YE9						
Vinyl Bench Seat			VUU1	VDD1	VRR1	VQQ1		
Custom Cloth Bench Seat (N/A Extended Cab)			LUU1	LDD1	LRR1	LQQ1		
Vinyl Reclining Low Back Bkt Seat			VUU2	VDD2	VRR2	VQQ2		
Vinyl Reclining Split Bench Seat (N/A Extended Cab)			VUU3	VDD3	VRR3	VQQ3		
Custom Cloth Reclining Split Bench Seat			LUU3	LDD3	LRR3	LQQ3		
Custom Cloth Reclining High Back Bucket Seats		LUU6	LDD6	LRR6	LQQ6			
EXTERIOR COLORS	Color Code 1	Color Code 2	INTERIOR & EXTERIOR COMBINATIONS SHOWN ARE ONLY COMBINATIONS AVAILABLE				STRIPE COLOR	K2500 w/C6P WHEEL FLARE COLOR
* Autumnwood, Dk (Met)/ Autumnwood, Lt (Met)	56	55	x				Beige/Autumnwood	N/A
Autumnwood, Lt (Met)/ Autumnwood, Dk (Met)	55	56	x				Beige/Autumnwood	Autumnwood
Black, Onyx/Autumnwood, Lt (Met)	41	55	x				Beige/Black	Black
Black, Onyx/Quicksilver (Met)	41	96			x	x	Gunmetal/Red	Black
Black, Onyx/Red, Victory (Met)	41	74				x	Silver/Red	Black
Blue, Indigo (Met)/Autumnwood, Lt (Met)	39	55	x	x			Autumnwood	Blue
Blue, Indigo (Met)/Blue, Lt Quasar (Met)	39	20		x		x	Blue/Silver	Blue
Blue, Indigo (Met)/Quicksilver (Met)	39	96		x		x	Blue/Silver	Blue
* Blue, Indigo (Met)/White, Summit	39	50		x		x	Blue/Silver	Blue
* Blue, Lt Quasar (Met)/Blue, Indigo (Met)	20	39		x		x	Blue/Silver	N/A
* Blue, Lt Quasar (Met)/Quicksilver (Met)	20	96		x		x	Blue/Silver	N/A
* Blue, Lt Quasar (Met)/White, Summit	20	50		x		x	Blue/Silver	N/A
Green, Teal (Met)/Quicksilver (Met)	38	96				x	Teal/Silver	N/A
Quicksilver (Met)/Black, Onyx	96	41			x	x	Gunmetal/Red	Silver
Quicksilver (Met)/Blue, Indigo (Met)	96	39		x		x	Blue/Silver	Silver
Quicksilver (Met)/Blue, Lt Quasar (Met)	96	20		x		x	Blue/Silver	Silver
Quicksilver (Met)/Green, Teal (Met)	96	38				x	Teal/Silver	Silver
Quicksilver (Met)/Red, Dk Garnet (Met)	96	84			x	x	Gunmetal/Silver	Silver
Quicksilver (Met)/Red, Victory	96	74			x	x	Gunmetal/Red	Silver
Red, Dk Garnet (Met)/Quicksilver (Met)	84	96			x	x	Gunmetal/Silver	Dk Red
* Red, Dk Garnet (Met)/White, Summit	84	50			x	x	Gunmetal/Silver	Dk Red
* Red, Victory/Black, Onyx	74	41			x	x	Silver/Red	N/A
* Red, Victory/Quicksilver (Met)	74	96			x	x	Gunmetal/Red	N/A
Red, Victory/White, Summit	74	50			x	x	Gunmetal/Red	N/A

* N/A C6P on K2500

MODELS**REGULAR CAB**

Fleetside 2-wheel drive (CC30903)	3
Fleetside 4-wheel drive (CK30903)	3

EXTENDED CAB

Fleetside 2-wheel drive (CC30953)	6
Fleetside 4-wheel drive (CK30953)	6

DIMENSIONS

Wheelbase	
C-K30903 (inches)	131.5
C-K30953 (inches)	155.5
Cab-Axle (inches)	55.9
Length (overall - inches).....	212.6
Width	
C-K30903 (overall-inches)	76.8
C-K30953 (overall-inches)	94.2
Box Size	
Length (overall - inches)	97.6
Depth (inches).....	19.3
Payload (pounds)	
CC30903	4674
CK30903	4511
CC30953	5180
CK30953	4690
GVWR	
CC30903	9000
CK30903	9200
C-K30953	10000
Fuel Tank Capacity	34 Gal.

POWER TEAMS**Standard Engine**

RPO L05 5.7 Liter H.D. (350 Cu In) V8 with Electronic Fuel Injection (EFI)

Standard Transmission

RPO MT8 H.D. 5-Speed Manual with Deep Low and Overdrive

Engine Oil Cooler**STANDARD EQUIPMENT SUMMARY****EXTERIOR**

Battery, 600 Cold Cranking Amps
 Brakes: Power assisted front disc, rear drum. Rear wheel anti-lock
 Bumper: Chrome front
 Grille: Molded painted argent
 Headlamps: Single rectangular halogen
 Lamps, Roof Marker (CK30953 Models)
 Mirrors: RH and LH below-eye-line, painted black
 Nameplate: Cheyenne
 Radiator, Heavy-Duty
 Tires: LT245/75R16-E All Seasons Steel Belted Radial Ply BW
 Tow Hooks: Two front on K3500 models
 Wheels: Silver painted steel with black hub ornament
 Wheel Opening Flares (K3500 Only): (Front only with R05 Dual Rear Wheels)
 Windshield Wipers: Intermittent

INTERIOR

Cigarette Lighter
 Cupholders, Mounted Under Dash with Bench or 60/40 Seat(s). Located in Center Console with Bucket Seats
 Dome Lamp: With switch in LH and RH door jamb
 Door Guard Beams: Side
 Floor Covering: Embossed color-keyed rubber mat
 Gages: Engine temperature, fuel level, odometer, oil pressure, speedometer, telltale lights, trip odometer and voltmeter
 Glass: Tinted, Solar-Ray, all windows
 Glove Box: Latched door and beverage holder
 Headliner: Color-keyed cloth with matching retainer molding
 Heater: Deluxe heater with windshield and side window defoggers
 Mirror: 10-inch rearview
 Radio: Electronically-tuned AM radio with fixed mast antenna
 Scotchgard Fabric Protector on cloth trim and door panels
Seats:
Regular Cab: 3-passenger all-vinyl trim front bench seat with head restraints and folding backrest
 Optional bucket seats also include console
Extended Cab: 3-passenger all-vinyl trim front 60/40 reclining split bench seat with driver and passenger easy entry feature
 Steering Wheel: Custom urethane 4-spoke
 Stop Lamp, Center-Mounted with Cargo Area Lamp
 Sunshades: Color-keyed cloth RH and LH padded

OPTIONAL UPLEVEL DECOR

SILVERADO DECOR LEVEL (RPO YE9)

The following equipment is in addition to or replacing items included in the Cheyenne decor

EXTERIOR

- Bumper: Chrome front bumper includes a black rub strip with bright trim
- Grille: Deluxe front appearance package with argent grille and bright trim
- Headlamps: Dual composite halogen
- Horn: Dual low and high note electric
- Moldings: Black body side moldings with bright trim and bright wheel opening on R04 Single Rear Wheel models
- Nameplate: Silverado
- Wheels: Rally wheel trim
- Windows: Swing-out, rear Quarter (C-K30953 Only)

INTERIOR

- Floor Covering: Color-keyed carpeting
- Floor Mats: Front removable, Color-Keyed Rubber (C-K30953 also includes rear mats)
- Radio: Electronically tuned AM/FM stereo w/seek-scan and digital clock
- Seats: 3-passenger with choice of custom vinyl or custom cloth front bench seat with head restraint and folding backrest. Optional bucket seats include console
- Steering Wheel, Sport
- Storage Tray: Full width behind seat on floor
- Sunshades: Cloth covered with storage strap on LH unit and visor mirror on RH unit

MODEL AND BODY

Description	Model No	Body	Description	Model No	Body		
2-WHEEL-DRIVE MODEL			4-WHEEL-DRIVE MODEL				
*17,247.68	Fleetside	CC30903**	E63	*19,858.68	Fleetside	CK30903**	E63
*20,492.00	Fleetside, Ext Cab	CC30953	E63	*22,890.00	Fleetside, Ext Cab	CK30953	E63

*Includes Destination & Handling Charges
 ** Reqs R05 Dual or R04 Single Rear Wheels

EMISSIONS (Must Specify One) (Refer Emission Requirements Section)

- FE9 Federal Emission Requirements (Satisfies High Altitude Emission Requirements)
- NG1 New York State Emission Requirements
- YF5 California Emission Requirements
- NB8 California or New York State Emission Override (Reqs FE9 Federal Emissions)
- NC7 Federal Emission Override (Reqs NG1 New York State or YF5 California Emissions)

*** GVWR SELECTOR**

Minimum Equipment Required for GVW Rating			
GVW Rating (lbs)	GAWR*		
	Front	Rear	
C30903			
9000	3600	6084	Reqs R04 Wheels and YGK or YHH Tires
10000	3600	7500	Reqs R05 Wheels ; N/A KL5 Eng
K30903			
9200	3750	6084	Reqs R04 Wheels and YGK or YHH Tires
10000	3750	7500	Reqs R05 Wheels
C30953			
10000	3600	7500	None
K30953			
10000	3750	7500	None

*GAWR's shown are the minimum for each axle with equipment listed. Other GAWR's are available, and they are determined as the minimum capacity of either axle, springs or tires.

CAPACITIES

C30903		AXLES:	
SPRINGS:		AXLES:	
Front		Front	
3600	Base	3800	Base
3800	w/R05	4250	w/R05
Rear		Rear	
6084	Base	6084	Base
7500	w/R05	7500	w/R05
C30953		AXLES:	
SPRINGS:		AXLES:	
Front		Front	
3800	Base	3800	Base
Rear		Rear	
7500	Base	7500	Base

K30903		AXLES	
SPRINGS:		AXLES	
Front		Front	
3750	Base	4250	Base
Rear		Rear	
6084	Base	6084	Base
7500	w/R05	7500	w/R05
K30953 <td colspan="2">AXLES </td>		AXLES	
SPRINGS:		AXLES	
Front		Front	
4250	Base	4250	Base
Rear		Rear	
7500	Base	7500	Base

POWER TEAMS (Must Specify Engine, Transmission and Rear Axle)

(Consult GVWR Selector For Minimum Equipment Required)

ENGINE	TRANSMISSION		AXLE			GVWR
	5-SP	AUTO	3.73	4.10	4.56	
CC30903						
L05 V8 5.7 Liter (350 Cu In)--EFI	MT8		(a) GT4	(a) GT5	(a) HC4	9000
		MX0	--	GT5	(a) HC4	9000
L05 V8 5.7 Liter H.D. (350 Cu In)--EFI	MT8		--	(a) GT5	--	10000
		MX0	--	GT5	(a) HC4	10000
L19 V8 7.4 Liter (454 Cu In)-EFI	MT8		GT4	(a) GT5	--	9000
		MX0	GT4	GT5	(a) HC4	9000
L19 V8 7.4 Liter (454 Cu In)-EFI	MT8		(a) GT4	(a) GT5	(a) HC4	10000
		MX0	GT4	GT5	(a) HC4	10000
L65 Turbo Diesel 6.5 Liter V8 (400 Cu In)	MT8	MX0	GT4	GT5	--	9000/10000
CK30903						
L05 V8 5.7 Liter (350 Cu In)--EFI	MT8		(a) GT4	(a) GT5	(a) HC4	9200
		MX0	--	GT5	(a) HC4	9200
L05 V8 5.7 Liter H.D. (350 Cu In)--EFI	MT8	MX0	--	(a) GT5	--	10000
L19 V8 7.4 Liter (454 Cu In)-EFI	MT8		GT4	GT5	(a) HC4	9200
		MX0	(a) GT4	GT5	HC4	9200
L19 V8 7.4 Liter (454 Cu In)-EFI	MT8		(a) GT4	(a) GT5	(a) HC4	10000
		MX0	(a) GT4	GT5	(a) HC4	10000
L65 Turbo Diesel 6.5 Liter V8 (400 Cu In)	MT8	MX0	GT4	GT5	--	9200/10000
CC30953						
L05 V8 5.7 Liter (350 Cu In)--EFI	MT8		--	(a) GT5	(a) HC4	10000
		MX0	--	GT5	(a) HC4	10000
L19 V8 7.4 Liter (454 Cu In)	MT8		GT4	GT5	(a) HC4	10000
		MX0	GT4	GT5	HC4	10000
L65 Turbo Diesel 6.5 Liter V8 (400 Cu In)	MT8	MX0	GT4	GT5	--	10000
CK30953						
L05 V8 5.7 Liter (350 Cu In)--EFI	MT8	MX0	--	(a) GT5	--	10000
L19 V8 7.4 Liter (454 Cu In)	MT8	MX0	GT4	GT5	(a) HC4	10000
L65 Turbo Diesel 6.5 Liter V8 (400 Cu In)	MT8	MX0	GT4	GT5	--	10000

(a) Reqs FE9 Federal or NG1 New York State Emissions

TIRES (Must Specify Front and Rear Tire) (Spare is Optional and Includes Tire Carrier)

Description	Highway			On-Off Road			Spare
	Single Front	Dual Rear	Dual Rear	Single Front	Dual Rear	Dual Rear	
C30903 - C30953							
TUBELESS Steel Belted Radial							
LT225/75R16-C B/W	XHE						
LT225/75R16-D B/W			YHP				ZHP
LT225/75R16-D B/W						YHR	ZHR
LT225/75R16-D B/W	XHP		YHP				ZHP
LT225/75R16-D B/W	XHP					YHR	ZHR
(a) LT245/75R16-E B/W	XHH	YHH					ZHH
(a) LT245/75R16-E B/W	XHH				YGK		ZGK
K30903 - K30953							
TUBELESS Steel Belted Radial							
LT225/75R16-D B/W				XHR		YHR	ZHR
LT225/75R16-D B/W	XHP		YHP				ZHP
(a) LT245/75R16-E B/W	XHH	YHH					ZHH
(a) LT245/75R16-E B/W				XGK	YGK		ZGK

(a) Reqs R04 Single Rear Wheels; N/A C-K30953

B/W = Blackwall

MUST SPECIFY:

AXLE, EMISSION, ENGINE, TIRES AND TRANSMISSION

**No Deletions Allowed, Additional Options/Upgrades (Where Indicated)
May be Ordered from the Custom Ordering Option Listing**

		CHEYENNE		SILVERADO	
		P 3 A 1	P 3 A 2	P 3 A 3	P 3 A 4
Preferred Equipment Group 1					
Body: Fleetside	E63	x	x	x	x
Preferred Equipment Group 2					
Air Conditioning	C60		x	x	x
Radio: AM/FM Stereo w/Clock (A)	UM7		x	x	N/I
Preferred Equipment Group 3					
Silverado Decor	YE9			x	x
Lighting, Auxiliary	TR9			x	x
Mirrors: Below-Eye-Line, Stainless Steel (B)	D45			x	x
Preferred Equipment Group 4					
Convenience Group: Tilt Wheel and Speed Control	ZQ3				x
Convenience Group: Power Locks and Windows	ZQ2				x
Radio: AM/FM Stereo w/Tape (C)	UM6				x

Allowable Substitutions (Where Available):

- (A) UM7: May substitute UM6 or UX1 Stereo Radio
- (B) D45: May substitute DF2 Mirrors or Z81 Camper Special
- (C) UM6: May substitute UX1 Stereo Radio

Preferred Equipment Group Prices

N/C	P3A1	*1912.00	P3A3
		**(-400.00)	PEG 3 SAVINGS
*975.00	P3A2	**(-600.00)	REGULAR CAB
**(-400.00)	PEG 2 SAVINGS		EXTENDED CAB
		*2784.00	P3A4
		**(-600.00)	PEG 4 SAVINGS
		**(-700.00)	REGULAR CAB
			EXTENDED CAB

* The Preferred Equipment Group MSRPs Reflect the Basic Group Equipment Prices. For any Option Additions, Upgrades or Substitutions, Refer to the Vehicle Price Schedule for any Price Differential.

**PEG Savings Amount represents the savings for Preferred Equipment Groups.

ADDITIONAL OPTIONS

INCL w/PEG	OPTION	
		ACKNOWLEDGEMENTS
N.C.	R8S	Multiple Order Numbers
N.C.	R8T	Preliminary Invoice
	2,3,4	C60 AIR CONDITIONING: (Incls R134A Refrigerant) w/P3A2 or P3A3 or P3A4 w/P3A1
805.00		V22 APPEARANCE PACKAGE: (Incls Chrome Grille, Composite Halogen Headlamps and Dual Horns) (Incl w/Silverado Decor) w/P3A3 or P3A4 w/P3A1 or P3A2
N.C.		AXLES, REAR: (Refer Power Teams Chart for Availability)
191.00		GT4 3.73 Ratio
N.C.		GT5 4.10 Ratio
N.C.		HC4 4.56 Ratio
252.00		G80 Locking Differential (w/R04 Single Rear Wheels, Reqs GT5 or HC4 Axle)
		TP2 BATTERY: Heavy-Duty, Auxiliary (N/A Diesel Eng) (Incl w/Z81 Camper Special) w/Z81 w/o Z81
N.C.		BZY BEDLINER: Under Rail (N/A P13 Wheel Carrier)
134.00	1,2,3,4	E63 BODY CODE: Fleetside Body
225.00		BUMPER EQUIPMENT:
N.C.		VB3 Bumper, Chromed, Rear Step w/Rub Strip
229.00		VG3 Bumper, Chromed, Front Deluxe w/Rub Strip (Incl w/Silverado Decor) w/P3A3 or P3A4 w/P3A1 or P3A2
N.C.		V43 Bumper, Painted, Rear Step
26.00		V27 Bumper Guards, Front, Black (Reqs VG3 Bumper or Silverado Decor) (Incl w/L65 Eng w/Silverado Decor) w/Diesel Eng w/o Diesel Eng
130.00		Z81 CAMPER SPECIAL CHASSIS EQUIPMENT: Basic Camper Group (N/A D45 Mirrors) (Incls DF2 Camper Type Stainless Steel Mirrors and Camper Wiring Harness) (Also Incls TP2 H.D. Auxiliary Battery w/o Diesel Eng) w/Diesel Eng or P3A3/P3A4 w/o Diesel Eng w/P3A3/P3A4 w/Diesel Eng w/P3A1/P3A2 w/o Diesel Eng and P3A1/P3A2
N.C.		P13 CARRIER, SPARE WHEEL AND TIRE: Side Mounted (N/A K30953, R05 Dual Rear Wheels or BZY Bedliner)
32.00		V10 COLD-CLIMATE PACKAGE: (N/A Diesel Eng) (Incls Eng Block Heater)
		CONVENIENCE GROUP:
54.00	4	ZQ3 Tilt-Wheel and Speed Control w/P3A4 w/P3A1 or P3A2 or P3A3
188.00		ZQ2 Power Door Locks and Windows w/P3A4 w/P3A1 or P3A2 or P3A3
99.00		KNP COOLER, TRANSMISSION: Heavy-Duty, Auxiliary (Reqs MX0 Trans)
233.00		C49 DEFOGGER: Rear Window, Electric (Reqs Silverado Decor) (N/A A28 Window or C-K30903)
N.C.		EMISSIONS: (Refer Emission Requirement Tab Section)
N.C.		FE9 Federal Emission Requirements (Satisfies High Altitude Requirements)
N.C.		NG1 New York State Emission Requirements
N.C.		YF5 California Emission Requirements
N.C.		NB8 California or New York State Emission Override (Reqs FE9 Federal Emissions)
N.C.		NC7 Federal Emission Override (Reqs NG1 New York State or YF5 California Emissions)
		ENGINES: (Refer Power Teams Chart for Availability)
N.C.		L05 5.7 Liter H.D. V8 (350 Cu In) EFI
470.00		L19 7.4 Liter V8 (454 Cu In) EFI
2825.00		L65 6.5 Liter V8 Turbo Diesel (400 Cu In) (Incls V27 Bumper w/Silverado Decor)
125.00		KL5 Alternative Fuel (LPG or CNG Conversion Ready) (C309*3, K30903 Reqs HC4 Axle) (Reqs L05 Eng and MX0 Trans) (C/K30903 N/A R05 Dual Rear Wheels)
		BG9 FLOOR COVERING: Full Floor, Rubber, Color-Keyed (Replaces Carpeting and Floor Mats) (Reqs Silverado Decor) w/C-K30*03 w/C-K30*53
(-20.00)		AJ1 GLASS: Deep Tinted Solar-Ray (Incls A20 Swing-Out Quarter Windows) (When C49 Defogger or A28 Window is Specified, Rear Window is Light Tint Glass) (N/A C-K30903) w/P3A3 or P3A4 and A28 or C49 w/P3A3 or P3A4 w/o A28 or C49 w/P3 A1 or P3A2 and A28 or C49 w/P3A1 or P3A2 w/o A28 or C49
(-36.00)		
72.00		
107.00		
115.00		
150.00		

ADDITIONAL OPTIONS

INCL w/PEG	OPTION	
		LAMPS:
N.C. 33.00	C95	Dome and Reading: (Incl w/TR9 Lighting) w/TR9 w/o TR9
N.C. 52.00 N.C.	U01	Roof Marker (Standard on C-K30953) (N/A YF5 Calif Emissions w/R04 Rear Wheels) (Incl w/R05 Dual Rear Wheels) w/R05 w/R04
N.C. 94.00	3,4 VK3 TR9	LICENSE PLATE BRACKET: Front LIGHTING, AUXILIARY: (Incls C95 Dome and Reading Lamps, Ashtray, Glovebox and Underhood Lamps) w/P3A3 or P3A4 w/P3A1 or P3A2
N.C. 45.00	3,4 D45	MIRRORS, EXTERIOR: Below-Eye-Line Type. Stainless Steel w/P3A3 or P3A4 w/P3A1 or P3A2
N.C. 8.00 53.00	DF2	Camper Type. Stainless Steel (Incl w/Z81 Camper Special) w/Z81 w/P3A3 or P3A4 w/P3A1 or P3A2
N.C. 76.00 107.00	B85	MOLDING: Exterior, Bright (Incl w/Silverado Decor w/o R05 Dual Rear or w/o K30953) (N/A R05 Dual Rear Wheels or K30953) (C30903 Incls Body Side and Wheel Opening Moldings) (K30903 Incls Body Side Molding Only) w/P3A3 or P3A4 w/K30903 w/C309*3
N.C. 132.00 243.00	ZY1 ZY2 ZY4	PAINT, EXTERIOR: (Refer Color/Trim Chart for Availability) Solid Conventional Two-Tone Deluxe Two-Tone
N.C. 170.00	2,3 UM7	RADIO EQUIPMENT: (Electronically Tuned AM Radio Standard) (Optional Radios Incl Premium Speakers) Electronically Tuned AM/FM Stereo Radio w/Seek-Scan and Digital Clock (Incl w/Silverado Decor) (N/A P3A4) w/P3A2 or P3A3 w/P3A1
N.C. 122.00 292.00	4 UM6	Electronically Tuned AM/FM Stereo Radio w/Seek-Scan, Stereo Cassette Tape and Digital Clock w/P3A4 w/P3A2 or P3A3 w/P3A1
150.00 272.00 442.00 (-117.00)	UX1	Electronically Tuned AM Stereo/FM Stereo Radio w/Seek-Scan, Stereo Cassette Tape w/Search and Repeat, Graphic Equalizer and Digital Clock w/P3A4 w/P3A2 or P3A3 w/P3A1
240.00 (-395.00)	UL5 AG9 YG4	Radio Delete (Reqs PEG P3A1) SEAT: Power Driver's Seat (Reqs Silverado Decor and Split Bench or Bucket Seats) (N/A C-K 30903) SEAT DELETE: (Reqs Cheyenne Decor) (N/A C-K30903) SEAT TRIM: (Refer Color/Trim Chart for Availability)
N.C. N.C.	V**1 C**1 V**2	Vinyl Bench Seat Cloth Bench Seat Vinyl Reclining Low Back Bucket Seat
115.00 289.00		w/C-K30953 w/C-K30903
115.00 289.00	C**2	Cloth Reclining Low Back Bucket Seat w/C-K30953 w/C-K30903
N.C. 174.00	V**3	Vinyl Reclining Split Bench Seat w/C-K30*53 w/C-K30*03
N.C. 174.00 N.C.	C**3	Cloth Reclining Split Bench Seat w/C-K30*53 w/C-K30*03
N.C. 174.00	L**1 L**3	Custom Cloth Bench Seat (N/A Ext Cab) Custom Cloth Reclining Split Bench Seat w/C-K30*53 w/C-K30*03
291.00 490.00	L**6	Custom Cloth Reclining High Back Bucket Seats w/C-K30*53 w/C-K30*03

ADDITIONAL OPTIONS

INCL w/PEG	OPTION	
95.00	NZZ	SKID PLATE: Off-Road (K3500 Only) (Incls Engine Front Differential and Transfer Case Shield)
118.00	VYU	SNOW PLOW PREP PACKAGE: (K30903 Only) (Incls F60 H.D. Front Springs)
N.C.	F60	SPRINGS, FRONT: Heavy Duty (K3500 Only) (Incl w/VYU Snow Plow Prep)
63.00		w/VYU
59.00	U16	w/o VYU TACHOMETER
38.00	V76	TIRES: (Refer Tire Chart for Availability; Vehicle Price Schedule for Prices)
210.00	Z82	TOW HOOKS: (Standard on K3500 Models) TRAILERING SPECIAL EQUIPMENT: Heavy-Duty (Reqs VB3 or V43 Bumper) (Incls Trailer Hitch and Wiring Harness)
N.C.	MT8	TRANSMISSIONS: (Refer Power Teams Chart for Availability)
930.00	MX0	5-Speed Manual with Deep Low and Overdrive, Heavy -Duty 4-Speed Electronically Controlled Automatic with Overdrive, Heavy-Duty
42.00	P01	WHEEL TRIM: Wheel Covers (Reqs R04 Wheels) (N/A Silverado Decor or K30953)
N.C.	P06	Rally Wheel Trim (Incl w/Silverado Decor)
60.00		w/P3A3 or P3A4 w/P3A1 or P3A2
N.C.	R04	WHEELS, REAR: Note - One of the Following Wheel Options Must Be Specified on C-K 30903 models
N.C.	R05	Single Rear (Reqs YHH or YGK Tires) (N/A C-K30953) Dual Rear (Standard on C-K 30953 models) (Incls U01 Roof Marker Lamps and Tailgate Lamps)
955.00		C-K30953 C-K30903
113.00	A28	WINDOWS: Sliding Rear (N/A C49 Defogger)
N.C.	A20	Swing-Out Quarter (Incl w/AJ1 Glass or Silverado Decor) (N/A C-K30903)
43.00		w/P3A3 or P3A4 or AJ1 w/P3A1 or P3A2 or AJ1

**C/K 3500 PICKUP
PAINT APPLICATIONS
WITH ZY1, ZY2 AND ZY4 PAINT SCHEMES**

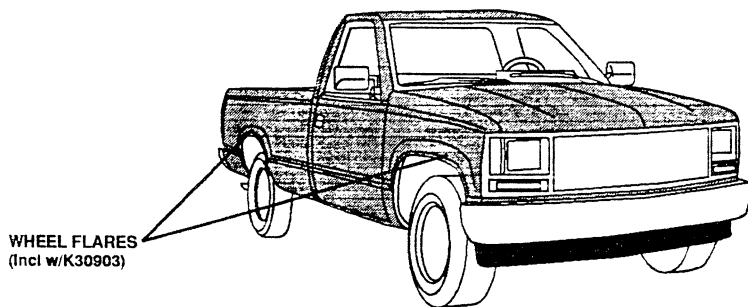

SOLID PAINT - ZY1

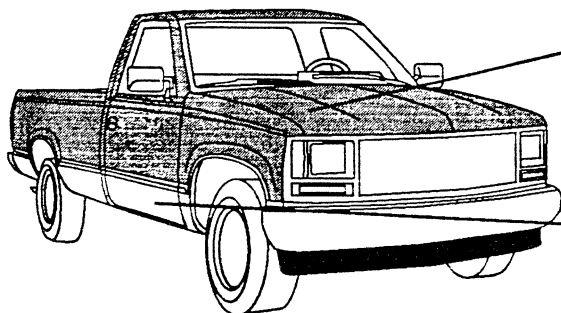

CONVENTIONAL TWO-TONE PAINT - ZY2 w/C30903

COLOR CODE 1

WHEEL FLARE

COLOR CODE 2

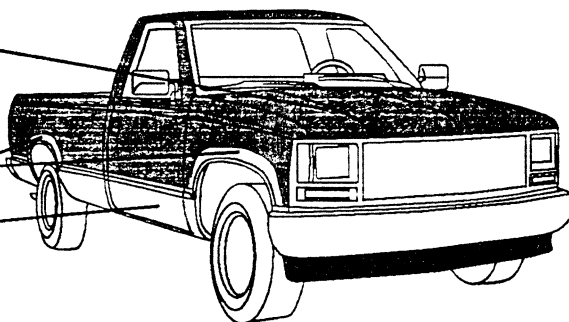

CONVENTIONAL TWO-TONE PAINT - ZY2 w/K30903

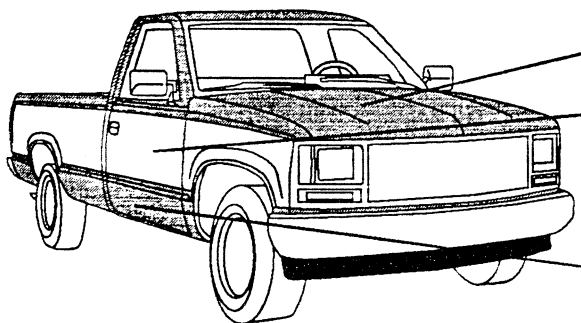

DELUXE TWO-TONE PAINT - ZY4 w/C30903
(Includes Body Striping)

COLOR CODE 1

COLOR CODE 2

WHEEL FLARE

COLOR CODE 1

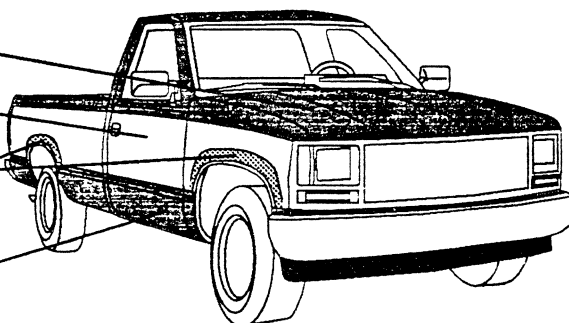

DELUXE TWO-TONE PAINT - ZY4 w/K30903
(Includes Body Striping)

C/K3500 PICKUP

INTERIOR AND EXTERIOR COLOR AVAILABILITY CHART WITH ZY1 AND ZY2 PAINT SCHEMES

PLEASE NOTE: Below are the interior trim color and exterior paint combinations recommended by Chevrolet. They are the only available interior and exterior combinations allowed.

TRIM LEVEL Seat Type	Decor	INTERIOR COLORS			
		Beige	Blue	Garnet	Gray
CHEYENNE	Std	VUU1	VDD1	VRR1	VQQ1
Vinyl Bench Seat (N/A Ext Cab)		CUU1	CDD1	CRR1	CQQ1
Cloth Bench Seat (N/A Ext Cab)		VUU2	VDD2	VRR2	VQQ2
Vinyl Reclining Low Back Bkt Seat		CUU2	CDD2	CRR2	CQQ2
Cloth Reclining Low Back Bkt Seat		VUU3	VDD3	VRR3	VQQ3
Vinyl Reclining Split Bench Seat		CUU3	CDD3	CRR3	CQQ3
Cloth Reclining Split Bench Seat					
SILVERADO	YE9	VUU1	VDD1	VRR1	VQQ1
Vinyl Bench Seat (N/A Ext Cab)		LUU1	LDD1	LRR1	LQQ1
Custom Cloth Bench Seat (N/A Ext Cab)		VUU2	VDD2	VRR2	VQQ2
Vinyl Reclining Low Back Bkt Seat		VUU3	VDD3	VRR3	VQQ3
Vinyl Reclining Split Bench Seat		LUU3	LDD3	LRR3	LQQ3
Custom Cloth Reclining Split Bench Seat		LUU6	LDD6	LRR6	LQQ6
Custom Cloth Reclining High Back Bucket Seats					

EXTERIOR COLORS	Color Code 1	Color Code 2	INTERIOR & EXTERIOR COMBINATIONS SHOWN ARE THE ONLY COMBINATIONS AVAILABLE				WHEEL FLARE COLOR (K3500)
AUTUMNWOOD, DARK (Metallic)	56	56	x				Argent
Autumnwood, Lt (Met)	56	55	x				Autumnwood
AUTUMNWOOD, LT (Metallic)	55	55	x				Autumnwood
* Autumnwood, Dk (Met)	55	56	x				N/A
BLACK, ONYX	41	41	x			x	Black
Autumnwood, Lt (Met)	41	55	x			x	Autumnwood
Quicksilver (Met)	41	96			x	x	Silver
BLUE, INDIGO(Metallic)	39	39	x	x			Blue
Autumnwood, Lt (Met)	39	55	x	x			Autumnwood
* Blue, Lt Quasar (Met)	39	20		x		x	N/A
Quicksilver (Met)	39	96		x		x	Silver
BLUE, LT QUASAR (Metallic)	20	20		x			Argent
Blue, Indigo (Met)	20	39		x		x	Blue
Quicksilver (Met)	20	96		x		x	Silver
GREEN, TEAL (Metallic)	38	38	x				Argent
Quicksilver (Met)	38	96				x	Silver
QUICKSILVER (Metallic)	96	96		x	x	x	Silver
Black, Onyx	96	41			x	x	Black
Blue, Indigo (Met)	96	39		x		x	Blue
* Blue, Lt Quasar (Met)	96	20		x			N/A
* Green, Teal (Met)	96	38				x	N/A
Red, Dk Garnet (Met)	96	84			x	x	Dk Red
RED, DK GARNET (Metallic)	84	84	x		x	x	Dk Red
Quicksilver (Met)	84	96			x	x	Silver
RED, VICTORY	74	74	x		x	x	Argent
Black, Onyx	74	41	x		x	x	Black
Quicksilver (Met)	74	96			x	x	Silver
WHITE, SUMMIT	50	50	x	x	x	x	Argent

* N/A K3500

C/K3500 PICKUP INTERIOR AND EXTERIOR COLOR AVAILABILITY CHART WITH ZY4 PAINT SCHEMES

PLEASE NOTE: Below are the interior trim color and exterior paint combinations recommended by Chevrolet. They are the only available interior and exterior combinations allowed.

TRIM LEVEL Seat Type	Decor	INTERIOR COLORS			
		Beige	Blue	Garnet	Gray
CHEYENNE	Std	VUU1	VDD1	VRR1	VQQ1
Vinyl Bench Seat (N/A Ext Cab)		CUU1	CDD1	CRR1	CQQ1
Cloth Bench Seat (N/A Ext Cab)		VUU2	VDD2	VRR2	VQQ2
Vinyl Reclining Low Back Bkt Seat		CUU2	CDD2	CRR2	CQQ2
Cloth Reclining Low Back Bkt Seat		VUU3	VDD3	VRR3	VQQ3
Vinyl Reclining Split Bench Seat		CUU3	CDD3	CRR3	CQQ3
Cloth Reclining Split Bench Seat					
SILVERADO	YE9	VUU1	VDD1	VRR1	VQQ1
Vinyl Bench Seat (N/A Ext Cab)		LUU1	LDD1	LRR1	LQQ1
Custom Cloth Bench Seat (N/A Ext Cab)		VUU2	VDD2	VRR2	VQQ2
Vinyl Reclining Low Back Bkt Seat		VUU3	VDD3	VRR3	VQQ3
Vinyl Reclining Split Bench Seat		LUU3	LDD3	LRR3	LQQ3
Custom Cloth Reclining Split Bench Seat		LUU6	LDD6	LRR6	LQQ6
Custom Cloth Reclining High Back Bucket Seats					

EXTERIOR COLORS	Color Code 1	Color Code 2	INTERIOR & EXTERIOR COMBINATIONS SHOWN ARE THE ONLY COMBINATIONS AVAILABLE				STRIPE COLOR	WHEEL FLARE COLOR (K3500)
* Autumnwood, Dk (Met)/ Autumnwood, Lt (Met)	56	55	x				Beige/Autumnwood	N/A
Autumnwood, Lt (Met)/ Autumnwood, Dk (Met)	55	56	x				Beige/Autumnwood	Autumnwood
Black, Onyx/Autumnwood, Lt (Met)	41	55	x				Beige/Black	Black
Black, Onyx/Quicksilver (Met)	41	96			x	x	Gunmetal/Red	Black
Black, Onyx/Red, Victory (Met)	41	74				x	Silver/Red	Black
Blue, Indigo (Met)/Autumnwood, Lt (Met)	39	55	x	x			Autumnwood	Blue
Blue, Indigo (Met)/Blue, Lt Quasar (Met)	39	20		x		x	Blue/Silver	Blue
Blue, Indigo (Met)/Quicksilver (Met)	39	96		x		x	Blue/Silver	Blue
Blue, Indigo (Met)/White, Summit	39	50		x		x	Blue/Silver	Blue
* Blue, Lt Quasar (Met)/Blue, Indigo (Met)	20	39		x		x	Blue/Silver	N/A
* Blue, Lt Quasar (Met)/Quicksilver (Met)	20	96		x		x	Blue/Silver	N/A
* Blue, Lt Quasar (Met)/White, Summit	20	50		x		x	Blue/Silver	N/A
* Green, Teal (Met)/Quicksilver (Met)	38	96				x	Teal/Silver	N/A
Quicksilver (Met)/Black, Onyx	96	41			x	x	Gunmetal/Red	Silver
Quicksilver (Met)/Blue, Indigo (Met)	96	39		x		x	Blue/Silver	Silver
Quicksilver (Met)/Blue, Lt Quasar (Met)	96	20		x		x	Blue/Silver	Silver
Quicksilver (Met)/Green, Teal (Met)	96	38				x	Teal/Silver	Silver
Quicksilver (Met)/Red, Dk Garnet (Met)	96	84			x	x	Gunmetal/Silver	Silver
Quicksilver (Met)/Red, Victory	96	74			x	x	Gunmetal/Silver	Silver
Red, Dk Garnet (Met)/Quicksilver (Met)	84	96			x	x	Gunmetal/Silver	Dk Red
Red, Dk Garnet (Met)/White, Summit	84	50			x	x	Gunmetal/Silver	Dk Red
* Red, Victory/Black, Onyx	74	41			x	x	Silver/Red	N/A
* Red, Victory/Quicksilver (Met)	74	96			x	x	Gunmetal/Red	N/A
* Red, Victory/White, Summit	74	50			x	x	Gunmetal/Red	N/A

* N/A K3500

C/K PICKUP INTRODUCTION

C/K PICKUP

The 1994 C/K Pickups are available in two trim levels: the "Cheyenne" (standard) and the "Silverado" (uplevel). Chevrolet will continue to offer its Work Truck model but will discontinue the 454 SS.

Changes on the C/K Pickup for 1994 include:

- 4.3L V6 Engine Enhancements
 - 4.3L V6 Engine Receives a Balance Shaft for Smoother Performance
 - 5.7L V8 Engine Enhancements
 - 6.5L V8 Diesel Engine with Natural Aspiration
 - 6.5L V8 Turbo Diesel Engine
 - 7.4L V8 Engine Enhancements
 - 7.4L V8 Engine available as a Regular Production Option for Conversion to Natural Gas in certain Heavy Duty applications
 - Redesigned Grilles
 - Sport Pickup Grille
 - Aluminum Radiators Replace Copper-Brass Radiators with 5.7L V8, 7.4L V8 and 6.5L V8 Diesel Engines
 - Center High-Mounted Stop Lamp to Meet FMVSS 108
 - Cruise Control Improvements
 - Enhanced Air Cleaner with Gasoline Engines
 - Two New Exterior Colors (Three on Crew Cab)
 - Improved Easy-Entry Seats on Extended Cab Models
 - Optional Solar-Ray® Deep-Tinted Glass
 - New Spark Plug Wires on the 5.7L V8 Engine
 - Electronic Exhaust Gas Recirculation (EGR) Solenoid Valve for Better Drivability and Reduced Exhaust Emissions
 - Parking Brake Pedal Improvements
 - R134a Refrigerant replaces the current R12 for an environmentally safe air conditioner
 - Revised Front Axle Halfshaft Boot on 4x4 Models
 - Side Door Guard Beams to Comply with FMVSS 214
 - Smoother Shifting 4L80-E Transmission with 5.7L V8 and 7.4L V8 Engines
 - Starter Motor with 5.7L V8 and 7.4L V8 Engines
 - Tire/Vehicle Maximum Speed Limiting on Certain Models
 - Underhood/Underbody Corrosion Protection Upgrade with the addition of coatings to many underbody components
-

MODEL SELECTION SUMMARY

Use the chart below to choose the model that fits your customer's needs. Note that the Maximum Payload is based on curb weight. Also, the Maximum Gross Trailer Weight is based on vehicles that are properly equipped. See your 1994 Chevrolet Truck Order Guide for details.

SERIES	MODEL NUMBER/ BODY CODE/ OPTION CODE	PASSENGER CAPACITY (STD./OPT.)	STANDARD ENGINE/ TRANS.	OPTIONAL ENGINE/ TRANS.	GVWR (LBS.)	GAWR (LBS.) FRONT/ REAR	MAXIMUM PAYLOAD (LBS.) BASED ON CURB WT.	MAX. GROSS TRAILER WT./ TONGUE LOAD (LBS.) PROPERLY EQUIPPED	MAX. GROSS TRAILER WT. KINGPIN LOAD (LBS.) PROPERLY EQUIPPED
TWO-WHEEL DRIVE MODELS									
C1500 REGULAR CAB									
SPORTSIDE SHORT BOX	CC10703/E62	3/2	4.3L V6/M5	4.3L V6/A4 5.0L V8/M5/A4 5.7L V8/M5/A4	5600	2950/3404	1791	5000/600 ² 6000/750 7500/900	5000/1200 ³ 6000/1500 7500/1800
FLEETSIDE SHORT BOX WT 1500	CC10703/E63/ X81	3/-	4.3L V6/M5	4.3L V6/A4	5600	2950/3404	1754	5000/600 ²	5000/1200 ³
FLEETSIDE SHORT BOX	CC10703/E63	3/2	4.3L V6/M5	4.3L V6/A4 5.0L V8/M5/A4 5.7L V8/M5/A4	5600	2950/3404	1811	5000/600 ² 6000/750 7500/900	5000/1200 ³ 6000/1500 7500/1800
FLEETSIDE LONG BOX WT1500	CC10903/E63/ X81/XET CC10903/E63/ X81/XFL	3/- 3/-	4.3L V6/M5 4.3L V6/M5	4.3L V6/A4 4.3L V6/A4	5600 6100	2950/3404 3150/3686	1657 2134	5000/600 ² 5000/600 ²	5000/1200 ³ 5000/1200 ³
FLEETSIDE LONG BOX	CC10903/E63/ YET or YEV	3/2	4.3L V6/M5	4.3L V6/A4 5.0L V8/M5/A4 5.7L V8/M5/A4	5600	2950/3404	1519	5000/600 ² 6000/750 7500/900	5000/1200 ³ 6000/1500 7500/1800
FLEETSIDE LONG BOX HD	CC10903/E63 (Reqs. YFL, YFM, YFN or YCN tires)	3/2	4.3L V6/M5	4.3L V6/A4 5.0L V8/M5/A4 5.7L V8/M5/A4 6.5L V8/M5/A4 6.5L V8 ¹ /A4	6100	3150/3686	2089	5000/600 ² 6000/750 7500/900 7000/850 7000/850	5000/1200 ³ 6000/1500 7500/1800 7000/1700 7000/1700
C1500 EXTENDED CAB									
SPORTSIDE SHORT BOX	CC10753/E62	6/5/3	4.3L V6/M5	4.3L V6/A4 5.0L V8/M5/A4 5.7L V8/M5/A4 6.5L V8/M5/A4 6.5L V8 ¹ /A4	6200	3500/3686	2007	5000/600 ² 6000/750 7500/900 7000/850 7000/850	5000/1200 ³ 6000/1500 7500/1800 7000/1700 7000/1700
FLEETSIDE SHORT BOX	CC10753/E63	6/5/3	4.3L V6/M5	4.3L V6/A4 5.0L V8/M5/A4 5.7L V8/M5/A4 6.5L V8/M5/A4 6.5L V8 ¹ /A4	6200	3500/3686	2014	5000/600 ² 6000/750 7500/900 7000/850 7000/850	5000/1200 ³ 6000/1500 7500/1800 7000/1700 7000/1700
FLEETSIDE LONG BOX	CC10953/E63	6/5/3	5.0L V8/M5	5.0L V8/A4 5.7L V8/M5/A4 6.5L V8/M5/A4 6.5L V8 ¹ /A4	6200	3500/3686	1874	6000/750 7500/900 7000/850 7000/850	6000/1500 7500/1800 7000/1700 7000/1700
C2500 REGULAR CAB									
FLEETSIDE LONG BOX	CC20903/E63	3/2	4.3L V6/M5	4.3L V6/A4 5.0L V8/M5/A4 5.7L V8/M5/A4 6.5L V8/M5/A4 6.5L V8 ¹ /A4	7200 7200	3150/4670 3400/4670	3117	5500/700 7500/900 8500/1000 7500/900 7500/900	5500/1300 7500/1800 8500/2100 7500/1800 7500/1800
FLEETSIDE LONG BOX HD	CC20903/E63/ C6P/ YHH or YGK	3/2	5.7L V8/M5	5.7L V8/A4 7.4L V8/M5/A4 6.5L V8 ¹ /M5/A4	8600	3600/6000	4115	10000/1000 10000/1000 9000/1000	10000/2500 11500/2800 9000/2200

¹ Turbo Diesel. ² 5500/700 with NA6 High Altitude Emissions.

³ 5500/1300 with NA6 High Altitude Emissions.

See the following pages for additional 2- and 4- Wheel Drive Models.

C/K PICKUP

SERIES	MODEL NUMBER/ BODY CODE/ OPTION CODE	PASSENGER CAPACITY (STD./OPT.)	STANDARD ENGINE/ TRANS.	OPTIONAL ENGINE/ TRANS.	GVWR (LBS.)	GAWR (LBS.) FRONT/ REAR	MAXIMUM PAYLOAD (LBS.) BASED ON CURB WT.	MAX. GROSS TRAILER WT./ TONGUE LOAD (LBS.) PROPERLY EQUIPPED	MAX. GROSS TRAILER WT./ KINGPIN LOAD (LBS.) PROPERLY EQUIPPED
TWO-WHEEL DRIVE MODELS (CONT.)									
C2500 EXTENDED CAB									
FLEETSIDE SHORT BOX	CC20753/E63	6/5/3	5.0L V8/M5	5.0L V8/A4 5.7L V8/M5/A4 6.5L V8/M5/A4 6.5L V8 ¹ /A4	7200	3600/4670	2796	6500/800 8500/1000 7500/900 7500/900	6500/1600 8500/2100 7500/1800 7500/1800
FLEETSIDE LONG BOX HD	CC20953/E63/ C6P/ YHH or YGK	6/5/3	5.7L V8/M5	5.7L V8/A4 7.4L V8/M5/A4 6.5L V8 ¹ /M5/A4	8600	3600/6000	3689	10000/1000 10000/1000 9000/1000	10000/2500 11500/2800 9000/2200
C3500 REGULAR CAB									
FLEETSIDE LONG BOX	CC30903/E63 YGK or YHH	3/2	5.7L V8/M5	5.7L V8/A4 7.4L V8/M5/A4 6.5L V8 ¹ /M5/A4	9000	3600/6084	4276	9500/1000 10000/1000 9000/1000	9500/2300 13500/3300 9000/2200
FLEETSIDE LONG BOX DUAL REAR WHEELS	CC30903/E63/ R05	3/2	5.7L V8/M5	5.7L V8/A4 7.4L V8/M5/A4 6.5L V8 ¹ /M5/A4	10000	3600/7500	4904	9500/1000 10000/1000 9000/1000	9500/2300 13500/3300 9000/2200
C3500 EXTENDED CAB									
FLEETSIDE LONG BOX DUAL REAR WHEELS	CC30953/E63/ R05	6/5/3	5.7L V8/M5	5.7L V8/A4 7.4L V8/M5/A4 6.5L V8 ¹ /M5/A4	10000	3600/7500	4589	9500/1000 10000/1000 9000/1000	9500/2300 13500/3300 9000/2200
C3500 CREW CAB									
SINGLE REAR WHEELS	CC30943/E63	6/5	5.7L V8/M5	5.7L V8/A4 7.4L V8/M5/A4 6.5L V8 ¹ /M5/A4	9000	4100/6084	3521	9000/1000 10000/1000 8500/1000	9000/2200 13000/3200 8500/2100
SINGLE REAR WHEELS CAMPER SPECIAL	CC30943/E63/ Z81	6/5	5.7L V8/M5	5.7L V8/A4 7.4L V8/M5/A4 6.5L V8 ¹ /M5/A4	9600	4100/6084	4198	9000/1000 10000/1000 8500/1000	9000/2200 13000/3200 8500/2100
DUAL REAR WHEELS	CC30943/E63/ R05	6/5	5.7L V8/M5	5.7L V8/A4 7.4L V8/M5/A4 6.5L V8 ¹ /M5/A4	10000	4100/7500	4321	9000/1000 10000/1000 8500/1000	9000/2200 13000/3200 8500/2100

¹ Turbo Diesel

See the following pages for 4-Wheel Drive Models.

C/K PICKUP

SERIES	MODEL NUMBER/ BODY CODE/ OPTION CODE	PASSENGER CAPACITY (STD./OPT.)	STANDARD ENGINE/ TRANS.	OPTIONAL ENGINE/ TRANS.	GVWR (LBS.)	GAWR (LBS.) FRONT/ REAR	MAXIMUM PAYLOAD (LBS.) BASED ON CURB WT.	MAX. GROSS TRAILER WT./ TONGUE LOAD (LBS.) PROPERLY EQUIPPED	MAX. GROSS TRAILER WT./ KINGPIN LOAD (LBS.) PROPERLY EQUIPPED
FOUR-WHEEL DRIVE MODELS									
K1500 REGULAR CAB									
SPORTSIDE SHORT BOX	CK10703/E62	3/2	4.3L V6/M5	4.3L V6/A4 5.0L V8/M5/A4 5.7L V8/M5/A4	6100	3600/3750	1741	5000/600 6500/800 7000/850	5000/1200 6500/1600 7000/1700
FLEETSIDE SHORT BOX WT 1500	CK10703/E63/ X81	3/-	4.3L V6/M5	4.3L V6/A4	6100	3600/3750	1981	5000/600	5000/1200
FLEETSIDE SHORT BOX	CK10703/E63	3/2	4.3L V6/M5	4.3L V6/A4 5.0L V8/M5/A4 5.7L V8/M5/A4	6100	3600/3750	1877	5000/600 6500/800 7000/850	5000/1200 6500/1600 7000/1700
FLEETSIDE LONG BOX WT1500	CK10903/E63/ X81	3/-	4.3L V6/M5	4.3L V6/A4	6100	3600/3750	1742	5000/600	5000/1200
FLEETSIDE LONG BOX	CK10903/E63	3/2	4.3L V6/M5	4.3L V6/A4 5.0L V8/M5/A4 5.7L V8/M5/A4 6.5L V8/M5/A4 6.5L V8 ¹ /A4	6100	3600/3750	1703	5000/600 6500/800 7000/850 6500/800 6500/800	5000/1200 6500/1600 7000/1700 6500/1600 6500/1600
K1500 EXTENDED CAB									
SPORTSIDE SHORT BOX	CK10753/E62	6/5/3	4.3L V6/M5	4.3L V6/A4 5.0L V8/M5/A4 5.7L V8/M5/A4	6200	3600/3750	1621	5000/600 6500/800 7000/850	5000/1200 6500/1600 7000/1700
SPORTSIDE SHORT BOX HD	CK10753/E62/ F44	6/5/3	4.3L V6/M5	4.3L V6/A4 5.0L V8/M5/A4 5.7L V8/M5/A4 6.5L V8/M5/A4 6.5L V8/A4 ¹	6600	3600/3750	1884	5000/600 6500/800 7000/850 6500/800 6500/800	5000/1200 6500/1600 7000/1700 6500/1600 6500/1600
FLEETSIDE SHORT BOX	CK10753/E63	6/5/3	4.3L V6/M5	4.3L V6/A4 5.0L V8/M5/A4 5.7L V8/M5/A4	6200	3600/3750	1591	5000/600 6500/800 7000/850	5000/1200 6000/1600 7000/1700
FLEETSIDE SHORT BOX HD	CK10753/E63/ F44	6/5/3	4.3L V6/M5	4.3L V6/A4 5.0L V8/M5/A4 5.7L V8/M5/A4 6.5L V8/M5/A4 6.5L V8/A4 ¹	6600	3600/3750	1876	5000/600 6500/800 7000/850 6500/800 6500/800	5000/1200 6000/1600 7000/1700 6500/1600 6500/1600
FLEETSIDE LONG BOX	CK10953/E63	6/5/3	5.0L V8/M5	5.0L V8/A4 5.7L V8/M5/A4	6200	3600/3750	1372	6500/800 7000/850	6500/1600 7000/1700
FLEETSIDE LONG BOX HD	CK10953/E63/ F44	6/5/3	5.0L V8/M5	5.0L V8/A4 5.7L V8/M5/A4 6.5L V8/M5/A4 6.5L V8 ¹ /A4	6600 6800	3600/3750 3600/3750	1657 1893	6500/800 7000/850 ² 6500/800 6500/800	6500/1600 7000/1700 ³ 6500/1600 6500/1600

¹ Turbo Diesel

² 8500/1000 with NA6 High Altitude Emissions.

³ 8500/2100 with NA6 High Altitude Emissions.

C/K PICKUP

SERIES	MODEL NUMBER/ BODY CODE/ OPTION CODE	PASSENGER CAPACITY (STD./OPT.)	STANDARD ENGINE/ TRANS.	OPTIONAL ENGINE/ TRANS.	GVWR (LBS.)	GAWR (LBS.) FRONT/ REAR	MAXIMUM PAYLOAD (LBS.) BASED ON CURB WT.	MAX. GROSS TRAILER WT./ TONGUE LOAD (LBS.) PROPERLY EQUIPPED	MAX. GROSS TRAILER WT./ KINGPIN LOAD (LBS.) PROPERLY EQUIPPED
FOUR-WHEEL DRIVE MODELS (CONT.)									
K2500 REGULAR CAB									
FLEETSIDE LONG BOX	CK20903/E63	3/2	4.3L V6/M5	4.3L V6/A4	7200	3750/4670	2851	4500/550 6000/750 8000/950	4500/1100 6000/1500 8000/2000
				5.7L V8/M5/A4 6.5L V8/M5/A4 6.5L V8 ¹ /A4					
FLEETSIDE LONG BOX HD	CK20903/E63/ C6P YHH or YGK	3/2	5.7L V8/M5	5.7L V8/A4 7.4L V8/M5/A4 6.5L V8 ¹ /A4	8600	3750/6000	3742	9500/1000 10000/1000 8500/1000	9500/2300 11000/2700 8500/2100
K2500 EXTENDED CAB									
FLEETSIDE SHORT BOX	CK20753/E63	6/5/3	5.0L V8/M5	5.0L V8/A4 5.7L V8/M5/A4 6.5L V8/M5/A4 6.5L V8 ¹ /A4	7200	3750/4670	2489	6000/750 8000/950 7000/850 7000/850	6500/1600 8000/2000 7000/1700 7000/1700
FLEETSIDE LONG BOX HD	CK20953/E63/ C6P YGK or YHH	6/5/3	5.7L V8/M5	5.7L V8/A4 7.4L V8/M5/A4 6.5L V8 ¹ /M5/A4	8600	3750/6000	3249	9500/1000 10000/1000 8500/1000	9500/2300 11000/2700 8500/2100
K3500 REGULAR CAB									
FLEETSIDE LONG BOX	CK30903/E63 YGK or YHH	3/2	5.7L V8/M5	5.7L V8/A4 7.4L V8/M5/A4 6.5L V8 ¹ /M5/A4	9200	3750/6084	4091	9000/1000 10000/1000 8500/1000	9000/2200 13000/3200 8500/2100
FLEETSIDE LONG BOX DUAL REAR WHEELS	CK30903/E63/ R05	3/2	5.7L V8/M5	5.7L V8/A4 7.4L V8/M5/A4 6.5L V8 ¹ /M5/A4	10000	3750/7500	4674	7500/900 10000/1000 8500/1000	7500/1800 13000/3200 8500/2100
K3500 EXTENDED CAB									
FLEETSIDE LONG BOX DUAL REAR WHEELS	CK30953/E63/ R05	6/5/3	5.7L V8/M5	5.7L V8/A4 7.4L V8/M5/A4 6.5L V8 ¹ /M5/A4	10000	3750/7500	4023	7500/900 10000/1000 8500/1000	7500/1800 13000/3200 8500/2100
K3500 CREW CAB									
SINGLE REAR WHEELS	CK30943/E63	6/5	5.7L V8/M5	5.7L V8/A4 7.4L V8/M5/A4 6.5L V8 ¹ /M5/A4	9200	4500/6084	3392	8500/1000 10000/1000 8000/950	8500/2100 12500/3100 8000/2000
DUAL REAR WHEELS	CK30943/E63/ R05	6/5	5.7L V8/M5	5.7L V8/A4 7.4L V8/M5/A4 6.5L V8 ¹ /M5/A4	10000	4500/7500	3979	8500/1000 10000/1000 8000/950	8500/2100 12500/3100 8000/2000

¹ Turbo Diesel

POWERTRAINS

Chevrolet offers a variety of engines, transmissions and rear axle ratios for the C/K Pickups. The following charts detail basic engine, transmission and axle specifications. See your 1994 Chevrolet Truck Order Guide for details.

ENGINES								
ENGINE	4.3L V6	5.0L V8	5.7L V8	5.7L V8 HD	7.4L V8 HD	6.5L V8 DIESEL	6.5L V8 TURBO DIESEL	6.5L V8 TURBO DIESEL
Order Code	LB4	L03	L05	L05	L19	L49	L56	L65
Restrictions	8500 GVW or Under	Up To 7200 GVW	8500 GVW or Under	Above 8500 GVW	Above 8500 GVW	8500 GVW or Under	8500 GVW or Under	Above 8500 GVW
SAE Net Horsepower @ RPM	165@ 4000	175@ 4200	200@ 4000	190@ 4000	230@ 3600	155@ 3600	180@ 3400	190@ 3400
SAE Net Torque lbs. ft. @ RPM	235@ 2000	265@ 2800	310@ 2400	300@ 2400	385@ 1600	275@ 1700	360@ 1700	385@ 1700
Fuel System	EFI	EFI	EFI	EFI	EFI	IFI	TIDI	TIDI
Clutch Size (in.)	11	12	12	12	12	12	12	12
Standard Battery Cold Cranking Amps @ 0°F	600	600	600	600	600	2 @ 600 each	2 @ 600 each	2 @ 600 each
Standard Alternator Maximum Capacity (Amps)	100	100	100	100	100	100	100	100

TRANSMISSIONS				
	MANUAL		AUTOMATIC	
	MANUAL 5-SPEED W/OVERDRIVE (HM290) (MG5)	MANUAL 5-SPEED W/OVERDRIVE AND DEEP LOW HEAVY-DUTY (NP4500)	ELECTRONICALLY CONTROLLED AUTOMATIC 4-SPEED OVERDRIVE W/TORQUE CONVERTER CLUTCH (4L60-E)(M30)	ELECTRONICALLY CONTROLLED AUTOMATIC 4-SPEED W/OVERDRIVE HEAVY-DUTY (4L80-E)(MT1)
Transmission Order Code	MM5	MT8	MX0	MX0
Application	8500 GVW or Under	See Order Guide	8500 GVW or Under	Above 8500 GVW and Turbo Diesel
Synchronized Speeds	1/2/3/4/5	1/2/3/4/5	—	—
Gear Ratios				
First	4.02	6.34	3.06	2.48
Second	2.32	3.44	1.63	1.48
Third	1.40	1.71	1.00	1.00
Fourth	1.00	1.00	0.70	0.75
Fifth	0.73	0.73	—	—
Reverse	3.74	6.34	2.29	2.08
Power Take-Off	No	Yes	No	No

REAR AXLES																	
Availability	(See Order Guide)			(See Order Guide)			(See Order Guide)			(See Order Guide)			(See Order Guide)				
Make	GM			GM			GM			GM			GM				
Capacity (lbs.)	3750 Semi-Floating			4800 Semi-Floating			6000 Full-Floating			6000-6084 Full-Floating			7500 Full-Floating				
Pinion and Ring Gear Type	Hypoid			Hypoid			Hypoid			Hypoid			Hypoid				
Axle Ratio Code	GU4	GU6	GT4	GU6	GT4	GT5	GU6	GT4	GT5	HC4	GU6	GT4	GT5	HC4	GT4	GT5	HC4
Ratio	3.08	3.42	3.73	3.42	3.73	4.10	3.42	3.73	4.10	4.56	3.42	3.73	4.10	4.56	3.73	4.10	4.56
Pinion Teeth	13	12	11	12	11	10	12	11	10	9	12	11	10	9	11	10	9
Ring Gear Teeth	41	41	41	41	41	41	41	41	41	41	41	41	41	41	41	41	41
Ring Gear Diameter (in.)	8.5	8.5	8.5	9.5	9.5	9.5	9.5	9.5	9.5	9.5	10.5	10.5	10.5	10.5	10.5	10.5	10.5

Note: Axle Ratio availability depends on model, powertrain and emissions selected. See your 1994 Chevrolet Truck Order Guide for specific details.

C/K PICKUP

FRONT AXLES										
Availability	K1500 & K2500 w/7200 GVWR			K2500 w/C6P & K3500				K30943		
Make/Capacity (lbs.)	GM/3925			GM/4250				GM/4500		
Pinion and Ring Gear Type	Hypoid			Hypoid				Hypoid		
Ratio	3.42	3.73	4.10	3.42	3.73	4.10	4.56	3.73	4.10	4.56
Pinion Teeth	12	11	10	12	11	10	9	11	10	9
Ring Gear Teeth	41	41	41	41	41	41	41	41	41	41
Ring Gear Diameter (in.)	8.25	8.25	8.25	9.25	9.25	9.25	9.25	9.75	9.75	9.75
Differential Type	2-Pinion Tapered Roller			2-Pinion Tapered Roller				2-Pinion Tapered Roller		
Bearings, Type										
Lubricant Capacity (pints)	4.5			6				6		

Note: Axle Ratio availability depends on model, powertrain and emissions selected. See your 1994 Chevrolet Truck Order Guide for specific details.

TRIM LEVELS

Chevrolet offers C/K Pickups in two primary trim levels — “Cheyenne” and “Silverado.” The following chart details major standard features. See your 1994 Chevrolet Truck Order Guide for more details, including information on the WT 1500 and Sport Pickup.

CHASSIS EQUIPMENT		CHEYENNE (STANDARD)	SILVERADO (YE9)
KEY: ■ = STANDARD, — = NOT INCLUDED			
BRAKES	Power-assisted, front disc, rear drum; Self-adjusting. Includes rear-wheel anti-lock system that operates in 2-wheel drive only.	■	■
EXHAUST	Single.	■	■
FRAME	All-welded ladder-type, channel design and boxed front-end section. Section modulus (cu. in.): Reg. Cabs — 2.66 on C/K 1500 and C/K 2500 (2WD), 3.27 on C/K 1500 and C/K 2500 (4WD), 5.26 on C/K 2500 /C6P and C/K3500 (2WD), 5.25 on C/K2500 w/C6P and C/K3500 (4WD), Ext. Cabs — 3.37 on C/K1500 and C/K2500 (2WD), 4.06 on C/K 1500 and C/K2500 (4WD), 6.06 on C/K 2500 wC6P and C/K3500. Crew Cab — 7.49 on all models.	■	■
FUEL TANK	25.0 gallon (approx.) capacity on C/K 10703/53 and C/K 20753 models. 34.0 gallon (approx.) capacity on all other models.	■	■
REAR AXLE	Hypoid semi-floating on C/K 1500 and 2500. Full-floating on C/K 2500/C6P w/L19 or L65 and C/K3500.	■	■
SHOCK ABSORBERS	25 mm: C/K 1500 front and rear; 32 mm: Front on C/K2500 at 7200 lbs. GVWR and C/K3500. Rear on C/K2500 and 3500; 32 mm: Front on C/K2500 at 8600 lbs. GVWR and Crew Cab.	■	■
STABILIZER BAR	4x2: Front 1.25 inch; 4x4: Front 1.18 inch.	■	■
STEERING	Integral power.	■	■
SUSPENSION, FRONT	4x2: Independent with computer-selected coil springs. 4x4: Independent with computer-selected torsion springs.	■	■
SUSPENSION, REAR	C/K1500 and 2500: Semi-elliptic two-stage multi-leaf springs. C/K3500: Semi-elliptic two-stage multi-leaf springs main/auxiliary.	■	■
TOW HOOKS	Two front on 4x4s.	■	■

EXTERIOR EQUIPMENT			
AIR DAM	Black (not included on models at or above 8600 lbs. GVW).	■	■
BUMPER, FRONT	Chrome (w/black rub strip on Crew Cab). Chrome, includes black rub strip with bright trim.	■	—
GRILLE	Molded plastic painted medium argent with medium argent air intake areas. Deluxe chrome grille with medium argent intake areas.	■	—
HEADLAMPS	Single rectangular halogen. Dual composite halogen.	■	—
HORN	Single electric low-note. Dual low- and high-note.	■	—
INSULATION	Hood and cab-to-fender.	—	■
LAMPS	Center high-mounted stop lamp/cargo lamp.	■	■

C/K PICKUP

INTERIOR EQUIPMENT (CONT.)		CHEYENNE (STANDARD)	SILVERADO (YE9)
KEY: ■ = STANDARD, — = NOT INCLUDED			
RADIO	Electronically tuned AM radio with two 4" x 6" standard front dash speakers and fixed mast antenna. ETR AM/FM stereo radio with seek-scan and digital clock. Includes two 4" x 6" front dash standard speakers and two 4" x 6" rear extended-range speakers located to rear above door.	■ —	— ■
SEATS	Scotchgard™ Protection on all cloth seats and cloth door panels. Regular Cab: Front 3-passenger bench with head restraints and folding backrest. Extended Cab: Front reclining 3-passenger 40/60 split bench with head restraints, improved easy-entry feature with memory and folding rear bench seat. Crew Cab: Front 3-passenger bench with head restraints and folding backrest and rear 3-passenger bench with folding backrest.	■ ■ ■ ■	■ ■ ■ ■
STEERING WHEEL	Custom urethane 4-spoke. Sport urethane 4-spoke.	■ —	— ■
STORAGE TRAY	Full width behind seat on floor.	■	■
SUNSHADE	Color-keyed cloth RH and LH, padded. Color-keyed cloth RH and LH, padded with storage strap on LH unit and visor mirror on RH unit. Crew Cab: Padded, color-keyed cloth RH and LH sunshades with extenders and illuminated mirrors. LH sunshade has storage strap.	■ — —	— ■ ■
TOOLS	Mechanical jack and wheel wrench located behind front seat or on rear compartment floor.	■	■
TRIM PANELS	Extended Cabs have rear, upper, lower and side trim panels and a molded color-keyed, cloth headliner with matching retaining moldings.	■	■
WINDOWS	Solar-Ray® tinted glass.	■	■
WINDSHIELD WIPERS	Intermittent.	■	■

PREFERRED EQUIPMENT GROUPS

Preferred Equipment Groups (PEGs) are convenient option packages that can save your customers money. They would pay appreciably more by buying all the options in a Preferred Equipment Group as individual options. (Savings based on a comparison of Manufacturer's Suggested Retail Price of option packages versus MSRP of individual options purchased separately.) See your 1994 Chevrolet Truck Order Guide and Vehicle Price Schedule for specific information and prices.

OPTIONS

These options can be ordered individually in addition to the Preferred Equipment Groups if not already included. See your 1994 Chevrolet Truck Order Guide for specific availability and restrictions. The Option Code is listed in **bold type**.

Air Conditioning C60	Carrier, Spare Wheel & Tire (side mounted) P13	Cal./N.Y. Emissions Override NB8
Appearance Package: Chrome Grille, Composite Headlamps & Dual Horns (Incl. w/Silverado Decor and BYP Sport Package) V22	Cold Climate Package (includes Engine Block Heater, antifreeze protection to -32°F and special insulation) V10	Engines:
Axles, Rear	Convenience Package, Driver's (includes Tilt-Wheel™ Steering and Electronic Speed Control) ZQ3	4.3L V6 EFI LB4
3.08 GU4	Convenience Package, Operating (includes Power Door Locks and Power Windows) ZQ2	5.0L V8 EFI L03
3.42 GU6	Cooling System	5.7L V8 EFI L05
3.73 GT4	Engine Oil Cooler (manual Transmission only) KC4	7.4L V8 EFI L19
4.10 GT5	Engine and Transmission Oil Cooler (automatic Transmission only) V08	6.5L V8 Diesel L49
4.56 HC4	Heavy Duty Transmission KNP	6.5L V8 Turbo Diesel L56
Axle, Rear Locking Differential G80	Defogger, Rear Window (Extended and Crew Cab Only) C49	6.5L V8 Turbo Diesel L65
Battery, Heavy-Duty, Auxiliary TP2	Emissions	Alternative Fuel KL5
Bedliner BZY	Federal FE9	Floor Covering
Bumper, Painted Rear Step V43	High Altitude NA6	Full Floor Rubber, Color-Keyed (requires YE9 Silverado) BG9
Bumper, Chromed Rear Step w/ Rub Strip VB3	California YF5	Glass, Solar-Ray® Deep-Tinted, sides and rear (Extended and Crew Cab only, includes Swing-Out Windows A20 on Extended Cab) AJ1
Bumper, Chromed Front Deluxe w/Rub Strip VG3	New York State NG1	GWWR (non-merchandised codes for information only):
Bumper Guards, Front, Black V27	Federal Emissions Override NC7	5600 lbs. C5G
Camper Special Chassis Equipment (Includes Camper Mirrors DF2, seven-lead Wiring Harness, Auxiliary Battery TP2) Z81		6100 lbs. C5M
		6200 lbs. Q4B
		6600 lbs. C5S
		6800 lbs. C5U
		7200 lbs. C5Z
		8600 lbs. C6P

OPTIONS (CONT.)

- 9000 lbs. **C6U**
- 9200 lbs. **C6W**
- 9600 lbs. **C6Y**
- 10,000 lbs. **C7A**
- Heavy-Duty Chassis Package (K1500 Extended Cab only) (Incl. w/L49 or L56 Eng.) **F44**
- Lamps, Dome and Reading (included w/Auxiliary Lighting TR9) . **C95**
- Lamps, Roof Marker (included w/Dual Rear Wheels R05) **U01**
- License Plate Bracket, Front **VK3**
- Lighting Auxiliary (dome, reading, ashtray, glove box and underhood lamps) **TR9**
- Mirrors:
- Exterior, Below-Eye-Line Type (LH and RH stainless steel. Mirror head 9.0" x 6.5") N/A on Crew Cab **D45**
- Exterior, Remote Control 8.5" x 5.0" Below-Eye-Line, Electric, Painted (Crew Cab) **D48**
- Exterior Camper Type (LH and RH stainless steel. Mirror head: 7.5" x 10.5". Included w/ Camper Special Equipment Z81) **DF2**
- Moldings, Body-Side Black with Bright Trim **B85**
- Off-Road Chassis Package (K1500 only) (includes Bilstein 46 mm shocks and skid plate NZZ) **Z71**

- Paint, Exterior
- Solid **ZY1**
- Conventional Two-Tone **ZY2**
- Deluxe Two-Tone **ZY4**
- Pick-up Box Delete **ZW9**
- Radio Equipment:
- Radio Delete **UL5**
- ETR AM/FM Stereo Radio w/Seek-Scan, Stereo Cassette, Digital Clock **UM6**
- ETR AM/FM Stereo Radio w/ Seek-Scan, Digital Clock **UM7**
- ETR AM/FM Stereo Radio w/ Seek-Scan, Stereo Cassette with Search/Repeat, Graphic Equalizer and Digital Clock **UX1**
- Recreational Sales Package (For information purposes only. YF7 is available for ordering through authorized C.Q.A.C.P. manufacturers only) **YF7**
- Seat, Power Driver's Adjuster (Crew Cab and Ext. Cab models with YE9 Silverado only) **AG9**
- Seat, Rear 3-Passenger Bench not desired (Extended Cab Only) **YG4**
- Shock Absorbers, Front and Rear, Heavy-Duty (included w/Trailer Special Equipment Z82) **F51**
- Skid Plate (4x4 only) **NZZ**
- Snow Plow Prep Package (Reg. Cab 4x4 only) **VYU**
- Sport Equipment Package (E62 only) See Order Guide for details **BYP**

- Springs, Front Heavy-Duty (4x4 only) .. **F60**
- Scott Handling Package (includes 46 mm Bilstein gas-filled shocks and chrome wheels N83, C1500 only) ... **ZQ8**
- Tachometer **U16**
- Tow Hooks, Front (4x2 only) **V76**
- Trailer Special Equipment (includes seven-lead wiring harness, weight distributing hitch platform, and other equipment depending on model) **Z82**
- Transmissions
- 5-Speed Manual w/Overdrive **MM5(MG5)**
- 5-Speed Manual with Deep Low and Overdrive, H.D. **MT8**
- 4-Speed Electronic Automatic with Overdrive and torque converter clutch **MX0 (M30)**
- 4-Speed Electronically Controlled Automatic w/Overdrive, H.D. **MX0 (MT1)**
- Wheel Covers **P01**
- Wheels
- Rally Trim **P06**
- Cast Aluminum (15" x 7") (C1500) **N90**
- Cast Aluminum (16" x 7") (K1500) **PF4**
- Chrome Wheels (15" x 7")(C1500) ... **N83**
- Dual Rear (C/K3500 only) **R05**
- Windows, Sliding Rear **A28**
- Windows, Swing-Out Quarter (Extended Cab) **A20**
- Work Truck Package (See Order Guide for details) **X81**

TIRES

KEY: ALS = ALL-SEASON SBR = STEEL-BELTED RADIAL PLY BW = BLACKWALL WW = WHITEWALL WL = WHITE LETTERED HWY = HIGHWAY BL = BLACK LETTERED OOR = ON-OFF ROAD WOL = WHITE OUTLINE LETTERED

TIRE DESCRIPTION	FRONT	REAR	SPARE
P225/75R15	ALS/SBR/WL	XEV	ZEV
P225/75R15	ALS/SBR/BW	XET	ZET
P235/75R15	ALS/SBR/BW	XFL	ZFL
P235/75R15	ALS/SBR/WW	XFM	ZFM
P235/75R15	ALS/SBR/WL	XFN	ZFN
P275/60R15	ALS/SBR/BW	XCN	ZCN
LT225/75R16C	ALS/SBR/BW	XHE	ZHE
LT225/75R16C	OOR/SBR/BW	XHJ	ZHJ
LT225/75R16C	OOR/SBR/WOL	XHN	ZHN
LT225/75R16D	ALS/SBR/BW	XHP	ZHP
LT225/75R16D	OOR/SBR/BW	XHR	ZHR
LT245/75R16C	ALS/SBR/BW	XBK	ZBK
LT245/75R16C	OOR/SBR/BW	XBN	ZBN
LT245/75R16C	OOR/SBR/WOL	XBX	ZBX
LT245/75R16E	ALS/SBR/BW	XHH	ZHH
LT245/75R16E	OOR/SBR/BW	XGK	ZGK
LT265/75R16C	OOR/SBR/BW	XGL	ZGL
LT265/75R16C	OOR/SBR/WOL	XGM	ZGM

C/K PICKUP

DIMENSIONS

MODEL	C/K 1500 PICKUP REG. CAB/EXT. CAB SPORTSIDE/FLEETSIDE			C/K2500 PICKUP REG. CAB/EXT. CAB FLEETSIDE			C/K3500 PICKUP REG. CAB/ EXT. CAB FLEETSIDE		C/K 3500 PICKUP CREW CAB	
	MODEL NUMBER		C/K 10703 C/K 10753	C/K 10903 C/K 10953	C/K 20753	C/K 20903 C/K 20953		C/K 30903 C/K 30953		C/K 30943
BODY CODE/ OPTION CODE	E62	E63	E63	C5Z	C5Z	C6P	C6U & C6W	C7A (OPT.)	R04	R05
EXTERIOR DIMENSIONS										
BODY										
Wheelbase (in.)										
Reg. Cab	117.5		131.5	—		131.5	131.5	131.5	168.5	
Ext. Cab	141.5		155.5	141.5		155.5	155.5	155.5	—	
Overall Length (in.) w/o Rear Bumper										
Reg. Cab	194.4		213.1	—		213.1	213.1		250.1	
Ext. Cab	218.4		237.1	218.4		237.1	237.1		—	
Overall Height (in.)										
Reg. Cab-2WD	70.4			—	73.0	75.5	75.5		71.7	68.3
Reg. Cab-4WD	73.8			—	74.3	75.8	75.8		73.8	70.2
Ext. Cab-2WD	70.4			73.0	73.0	75.5	75.5		—	—
Ext. Cab-4WD	73.8			74.3	74.3	75.8	75.8		—	—
Maximum Width (in.)	77.1	76.8	76.8	76.8	76.8		76.8	94.3	76.8	94.3
Bumper to Axle (in.)										
Front	35.4		35.4	35.4	35.4		35.4		35.4	
Rear Overhang (w/o bumper)	41.4		46.1	41.4	46.1		46.1		46.1	
Cab Axle (in.)	42.0		56.0	41.8	55.9		55.9		55.9	
Cab to End of Frame (in.)	78.7		97.6	78.7	97.6		97.6		97.0	
Bumper to Back of Cab (in.)										
Reg. Cab	111.0			—	111.0		111.0		148.1	
Ext. Cab	135.0			135.0	135.0		135.0		—	
Ground to Top of Rear Load Floor (in.) 2WD	29.0			31.6	31.6	34.0	34.0		34.0	34.0
4WD	32.4			32.9	32.9	34.4	34.4		34.4	34.4
Ground Clearance (in.)										
Front/Rear										
Reg. Cab-2WD	7.0/8.4			—	7.8/7.8	8.4/8.1	7.9/7.6		8.0/7.7	
Reg. Cab-4WD	8.6/9.0			—	8.7/7.7	7.8/8.1	7.2/7.4		8.0/7.7	
Ext. Cab-2WD	7.2/7.1			7.9/7.7	7.9/7.7	8.4/8.0	7.9/7.6		—	
Ext. Cab-4WD	9.2/9.6			9.2/8.2	9.2/8.1	9.2/8.1	7.2/7.4		—	
CARGO BOX										
Inside Length at Floor (in.)	78.7		97.6	78.6	97.6		97.6		97.6	
Inside Width at Top (in.) Rear	49.1	61.9	61.9	61.9	61.9		61.9		61.9	
Inside Width at Floor (in.)	49.1	64.4	64.4	64.4	64.4		64.4		64.4	
Inside Width between Wheelhousings (in.)	49.1			49.1	49.1		49.1		49.1	
Inside Height (in.)	19.2			19.2	19.2		19.2		19.2	
Tailgate Width (in.) (Top)	50.9	62.0	62.0	62.0	62.0		62.0		62.0	
SIGN PANEL AREA (in.)										
Reg. Cab	17 x 48 3/4			17 x 48 3/4	17 x 48 3/4		17 x 48 3/4		—	
Ext. Cab	17 x 77 1/2			17 x 77 1/2	17 x 77 1/2		17 x 77 1/2		—	
Crew Cab	—			—	—		—		17 x 85	

INTERIOR DIMENSIONS

CAB										
Headroom (in.) Front/Rear ¹	39.9/37.5			39.9/37.5	39.9/37.5		39.9/37.5		39.9/40.8	
Legroom (in.) Front/Rear ¹	41.7/34.8			41.7/34.8	41.7/34.8		41.7/34.8		41.7/37.9	
Shoulder Room (in.) Front/Rear ¹	65.4/67.6			65.4/67.6	65.4/67.6		65.4/67.6		65.4/64.9	
Hip Room (in.) Front/Rear ¹	60.0/64.2			60.0/64.2	60.0/64.2		60.0/64.2		60.0/59.3	
Extended Cab Cargo Volume (cu. ft.) w/o Rear Seat	40.5			40.5	40.5		40.5		—	

¹ Rear dimensions apply to extended cab and crew cab models.

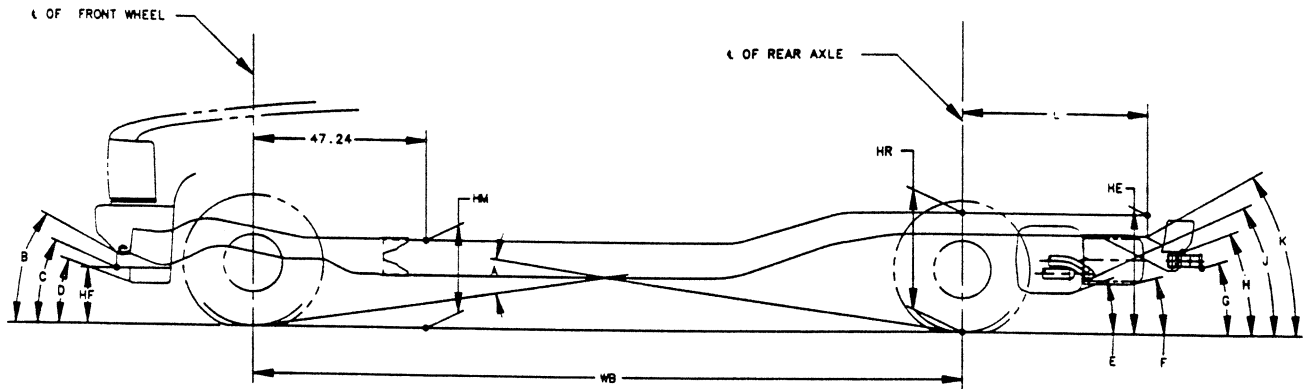

LETTER DESIGNATOR DEFINITIONS

FRAME HEIGHTS AND LENGTHS

- L** *Centerline of axle to end of frame*
- HF** *Bottom of bumper to ground*
- HM** *Inside top of frame to ground*
- HR** *Top of frame to ground at centerline of rear axle*
- HE** *Top of frame to ground*

ANGLE(S)

- A** *Ramp breakover*

ANGLE(S) (APPROACH)

- B** *Tow hooks*
- C** *Front bumper*
- D** *Spoiler*

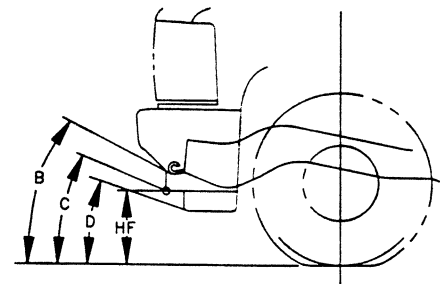

ANGLE(S) (DEPARTURE)

- E** *Fuel tank*
- F** *Spare tire*
- G** *Platform hitch*
- H** *Rear bumper*
- J** *Exhaust*
- K** *Chassis*

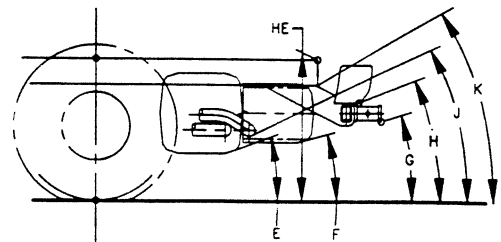

Note: All weights are in pounds and all dimensions are in inches.

C 10000 Models

C10703		117.5" Wheelbase					Frame Heights at Base Model Curb Weight				Frame Heights and Angular Dimensions are shown at Maximum GAWR Front and Rear													
GVW/Tire	L	Base Model Curb Weight			GAWR		HF	HM	HR	HE	HF	HM	HR	HE	A	B	C	D	E	F	G	H	J	K
		Frnt	Rr	Ttl	Frnt	Rr																		
5600 P225/75R15	36.9	2148	1579	3727	2950	3186	15.3	18.5	27.1	27.7	13.2	15.9	23.5	23.8	19		26	17		17	14	20	18	30
6100 P275/60R15	36.9	2262	1598	3860	3150	3686	14.9	18.6	27.1	28.0	12.5	15.1	22.5	22.8	18		25	16		15	13	18	20	29

C10753		141.5" Wheelbase					Frame Heights at Base Model Curb Weight				Frame Heights and Angular Dimensions are shown at Maximum GAWR Front and Rear													
GVW/Tire	L	Base Model Curb Weight			GAWR		HF	HM	HR	HE	HF	HM	HR	HE	A	B	C	D	E	F	G	H	J	K
		Frnt	Rr	Ttl	Frnt	Rr																		
6200 P235/75R15	36.8	2324	1688	4012	3500	3686	15.3	18.8	27.3	28.0	12.2	15.1	23.0	23.4	15		24	15		15	13	17	19	30

C10903		131.5" Wheelbase					Frame Heights at Base Model Curb Weight				Frame Heights and Angular Dimensions are shown at Maximum GAWR Front and Rear													
GVW/Tire	L	Base Model Curb Weight			GAWR		HF	HM	HR	HE	HF	HM	HR	HE	A	B	C	D	E	F	G	H	J	K
		Frnt	Rr	Ttl	Frnt	Rr																		
5600 P225/70R15	41.7	2210	1657	3867	2950	3186	14.8	18.2	26.6	27.3	12.8	15.4	23.1	23.4	16		25	16		16	14	17	19	26
6100 P235/75R15	41.7	2220	1582	3802	3150	3686	15.1	18.6	27.2	28.0	12.7	15.2	22.7	22.9	16		25	16		14	13	17	18	26

C10906		131.5" Wheelbase					Frame Heights at Base Model Curb Weight				Frame Heights and Angular Dimensions are shown at Maximum GAWR Front and Rear													
GVW/Tire	L	Base Model Curb Weight			GAWR		HF	HM	HR	HE	HF	HM	HR	HE	A	B	C	D	E	F	G	H	J	K
		Frnt	Rr	Ttl	Frnt	Rr																		
6800 P235/75R15		2146	2526	4672	2950	3968	16.3	18.3	25.2	25.2	11.7	14.0	21.2	21.3	9		23	14		11	10	15	15	23

C10953		155.5" Wheelbase					Frame Heights at Base Model Curb Weight				Frame Heights and Angular Dimensions are shown at Maximum GAWR Front and Rear													
GVW/Tire	L	Base Model Curb Weight			GAWR		HF	HM	HR	HE	HF	HM	HR	HE	A	B	C	D	E	F	G	H	J	K
		Frnt	Rr	Ttl	Frnt	Rr																		
6200 P235/75R15	41.7	2374	1777	4151	3500	3686	15.3	18.5	27.1	27.7	12.3	15.1	23.0	23.4	13		24	15		15	17	17	19	26

C 20000 Models

C20753		141.5" Wheelbase					Frame Heights at Base Model Curb Weight				Frame Heights and Angular Dimensions are shown at Maximum GAWR Front and Rear													
GVW/Tire	L	Base Model Curb Weight			GAWR		HF	HM	HR	HE	HF	HM	HR	HE	A	B	C	D	E	F	G	H	J	K
		Frnt	Rr	Ttl	Frnt	Rr																		
7200 LT225/75R16	36.8	2361	1771	4132	3600	4670	15.5	19.7	29.2	30.2	24.9	28.0	36.2	36.7	36	46	40	35	28	32	44	46		

C20903		131.5" Wheelbase					Frame Heights at Base Model Curb Weight				Frame Heights and Angular Dimensions are shown at Maximum GAWR Front and Rear													
GVW/Tire	L	Base Model Curb Weight			GAWR		HF	HM	HR	HE	HF	HM	HR	HE	A	B	C	D	E	F	G	H	J	K
		Frnt	Rr	Ttl	Frnt	Rr																		
7200 LT225/75R16	41.7	2259	1748	4007	3150	4670	15.5	19.8	29.2	30.5	14.1	16.7	24.3	24.6	19	28	19	18	15	19	22	18		
8600 LT245/75R16	41.7	2460	1937	4397	3600	6000	15.2	19.7	29.4	30.7	13.8	16.2	23.6	23.8	16	28	18	15	14	18	21	27		

C20906		131.5" Wheelbase					Frame Heights at Base Model Curb Weight				Frame Heights and Angular Dimensions are shown at Maximum GAWR Front and Rear													
GVW/Tire	L	Base Model Curb Weight			GAWR		HF	HM	HR	HE	HF	HM	HR	HE	A	B	C	D	E	F	G	H	J	K
		Frnt	Rr	Ttl	Frnt	Rr																		
8600 LT245/75R16		2453	2783	5236	3600	6000	16.5	20.3	28.99		14.3	17.6	25.8	26.5	19	29	20	19	17	21	26	30		

C20953		155.5" Wheelbase					Frame Heights at Base Model Curb Weight				Frame Heights and Angular Dimensions are shown at Maximum GAWR Front and Rear													
GVW/Tire	L	Base Model Curb Weight			GAWR		HF	HM	HR	HE	HF	HM	HR	HE	A	B	C	D	E	F	G	H	J	K
		Frnt	Rr	Ttl	Frnt	Rr																		
7200 LT225/75R16	41.7	2425	1862	4287	3600	4670	16.0	19.7	29.0	29.9	14.0	16.6	24.3	24.7	16	28	19	18	15	19	22	28		
8600 LT245/75R16	41.7	2667	2080	4747	3600	6000	16.0	19.8	29.0	30.0	14.7	16.7	23.6	23.6	16	29	20	16	14	18	20	27		

C 30000 Models

C30903		131.5" Wheelbase					Frame Heights at Base Model Curb Weight				Frame Heights and Angular Dimensions are shown at Maximum GAWR Front and Rear													
GVW/Tire	L	Base Model Curb Weight			GAWR		HF	HM	HR	HE	HF	HM	HR	HE	A	B	C	D	E	F	G	H	J	K
		Frt	Rr	Ttl	Frt	Rr																		
9000 LT245/75R16	41.7	2586	2064	4651	3600	6084	15.7	21.0	31.5	33.2	14.3	17.7	26.2	26.9	19	28	19	20	18	21	27	31		
10000 LT225/75R16	41.7	2647	2330	4977	3600	7500	15.1	20.3	30.5	32.1	14.0	16.9	24.7	25.2	19	28	19	18	15	19	23	29		

C30943		168.5" Wheelbase					Frame Heights at Base Model Curb Weight				Frame Heights and Angular Dimensions are shown at Maximum GAWR Front and Rear													
GVW/Tire	L	Base Model Curb Weight			GAWR		HF	HM	HR	HE	HF	HM	HR	HE	A	B	C	D	E	F	G	H	J	K
		Frt	Rr	Ttl	Frt	Rr																		
9000 LT245/75R16	41.7	2937	2354	5291	4100	6084	15.7	21.0	31.5	33.2	14.3	17.7	26.2	26.9	19	28	19	20	18	21	27	31		
9600 LT245/75R16	41.7	3010	2374	5384	4100	6084	16.3	20.6	30.8	32.0	14.9	17.9	26.2	26.6	12	30	21	19	17	21	23	30		
10000 LT225/75R16	41.7	2979	2205	5184	4100	7500	16.6	20.7	30.7	31.8	15.4	17.7	24.8	24.8	11	31	22	18	15	19	26	28		

C30953		155.5" Wheelbase					Frame Heights at Base Model Curb Weight				Frame Heights and Angular Dimensions are shown at Maximum GAWR Front and Rear													
GVW/Tire	L	Base Model Curb Weight			GAWR		HF	HM	HR	HE	HF	HM	HR	HE	A	B	C	D	E	F	G	H	J	K
		Frt	Rr	Ttl	Frt	Rr																		
9000 LT245/75R16	41.7	2779	2149	4928	3600	6084	16.0	20.7	31.3	32.7	15.1	18.1	26.2	26.7	17	30	21	19	17	21	26	31		
10000 LT225/75R16	41.7	2834	2409	5243	3600	7500	15.5	20.0	30.3	31.7	14.8	17.3	24.8	25.0	17	29	21	18	15	19	18	29		

C31003		135.5" Wheelbase					Frame Heights at Base Model Curb Weight				Frame Heights and Angular Dimensions are shown at Maximum GAWR Front and Rear													
GVW/Tire	L	Base Model Curb Weight			GAWR		HF	HM	HR	HE	HF	HM	HR	HE	A	B	C	D	E	F	G	H	J	K
		Frt	Rr	Ttl	Frt	Rr																		
9000 LT245/75R16	51.0	2684	1909	4593	3600	6084	21.7	24.6	30.3	30.8	21.6	22.4	25.8	24.9	24	41	34	19	12	15	21	19		
10000 LT225/75R16	51.0	2705	2235	4940	3880	7500	21.4	23.9	29.2	29.5	20.8	21.6	24.9	23.9	23	40	32	18	11	14	19	18		
11000 LT225/75R16	51.0	2709	2266	4975	4100	8250	21.5	23.9	29.2	29.4	20.6	21.3	24.5	23.6	22	39	32	18	11	14	18	18		
15000 LT225/70R19.5	51.0	3152	2514	5666	5000	11000	23.1	24.0	27.4	26.5	21.3	21.9	25.1	24.1	24	41	34	19	11	14	20	18		

C 30000 Models (continued)

C31403		159.5" Wheelbase					Frame Heights at Base Model Curb Weight				Frame Heights and Angular Dimensions are shown at Maximum GAWR Front and Rear													
GVW/Tire	L	Base Model Curb Weight			GAWR		HF	HM	HR	HE	HF	HM	HR	HE	A	B	C	D	E	F	G	H	J	K
		Frt	Rr	Ttl	Frt	Rr																		
9000 LT245/75R16	51.0	2794	1883	4677	3600	6084	21.7	24.5	30.4	30.8	21.5	22.5	25.8	25.1	21		41	34	13		19	28	21	19
10000 LT225/75R16	51.0	2850	2273	5123	3880	7500	21.3	23.8	29.2	29.4	20.7	21.7	24.9	24.1	19		40	32	12		18	22	19	18
11000 LT225/75R16	51.0	2858	2316	5174	4100	8250	21.3	23.8	29.1	29.3	20.5	21.5	24.6	23.8	19		39	32	12		18	22	19	18
15000 LT225/70R19.5	51.0	3310	2545	5855	5000	11000	17.6	22.3	31.0	32.7	20.6	23.4	29.3	29.7	23		40	33	19				31	24

C31803		183.5" Wheelbase					Frame Heights at Base Model Curb Weight				Frame Heights and Angular Dimensions are shown at Maximum GAWR Front and Rear													
GVW/Tire	L	Base Model Curb Weight			GAWR		HF	HM	HR	HE	HF	HM	HR	HE	A	B	C	D	E	F	G	H	J	K
		Frt	Rr	Ttl	Frt	Rr																		
15000 LT225/70R19.5	51.0	3362	2197	5559	5000	11000	22.0	25.7	33.3	34.3	20.6	23.4	29.3	29.6	20		40	33	22		53	60	24	31

K 10000 Models

K10516		111.5" Wheelbase					Frame Heights at Base Model Curb Weight				Frame Heights and Angular Dimensions are shown at Maximum GAWR Front and Rear													
GVW/Tire	L	Base Model Curb Weight			GAWR		HF	HM	HR	HE	HF	HM	HR	HE	A	B	C	D	E	F	G	H	J	K
		Frnt	Rr	Ttl	Frnt	Rr																		
6250 LT225/75R16		2459	2271	4730	3600	3750	15.4	18.2	28.1		11.4	15.1	25.7		16	17	23	13	27		21	28	33	

K10703		117.5" Wheelbase					Frame Heights at Base Model Curb Weight				Frame Heights and Angular Dimensions are shown at Maximum GAWR Front and Rear													
GVW/Tire	L	Base Model Curb Weight			GAWR		HF	HM	HR	HE	HF	HM	HR	HE	A	B	C	D	E	F	G	H	J	K
		Frnt	Rr	Ttl	Frnt	Rr																		
6200 LT245/75R16	36.8	2447	1700	4147	3350	3400	16.5	19.1	29.0	29.9	14.3	16.1	25.3	25.9	17	23	28	20		20	17	23	25	34
6600 LT245/75R16	36.8	2451	1658	4109	3600	3750	16.5	19.2	29.2	30.1	13.7	15.6	24.9	25.4	16	22	27	18		19	16	22	24	33

K10753		141.5" Wheelbase					Frame Heights at Base Model Curb Weight				Frame Heights and Angular Dimensions are shown at Maximum GAWR Front and Rear													
GVW/Tire	L	Base Model Curb Weight			GAWR		HF	HM	HR	HE	HF	HM	HR	HE	A	B	C	D	E	F	G	H	J	K
		Frnt	Rr	Ttl	Frnt	Rr																		
6200 LT245/75R16	36.8	2646	1784	4430	3600	3750	16.5	19.0	29.4	30.3	14.2	16.0	25.4	25.9	14	23	28	19		18	16	20	25	34
6600 LT245/75R16	36.8	2665	1849	4514	3600	3750	17.7	19.6	29.2	29.8	14.9	18.0	29.1	30.2	19	24	30	21		25	22	25	33	39

K10903		131.5" Wheelbase					Frame Heights at Base Model Curb Weight				Frame Heights and Angular Dimensions are shown at Maximum GAWR Front and Rear													
GVW/Tire	L	Base Model Curb Weight			GAWR		HF	HM	HR	HE	HF	HM	HR	HE	A	B	C	D	E	F	G	H	J	K
		Frnt	Rr	Ttl	Frnt	Rr																		
5600 LT225/75R16	41.7	2526	1769	4295	3400	3400	17.5	19.4	28.8	29.4	15.8	16.8	25.4	25.5	17	26	31	23		19	16	20	24	29
6100 LT225/75R16	41.7	2559	1680	4239	3600	3750	17.4	19.5	29.1	29.9	15.4	16.4	25.0	25.1	16	25	30	22		18	16	19	23	29

K10906		131.5" Wheelbase					Frame Heights at Base Model Curb Weight				Frame Heights and Angular Dimensions are shown at Maximum GAWR Front and Rear													
GVW/Tire	L	Base Model Curb Weight			GAWR		HF	HM	HR	HE	HF	HM	HR	HE	A	B	C	D	E	F	G	H	J	K
		Frnt	Rr	Ttl	Frnt	Rr																		
7200 LT245/75R16		2575	2542	5117	3600	4000	18.1	19.6	28.6		15.8	17.2	26.2		17	26	31	23	21		16	21	27	

K10953		155.5" Wheelbase					Frame Heights at Base Model Curb Weight				Frame Heights and Angular Dimensions are shown at Maximum GAWR Front and Rear													
GVW/Tire	L	Base Model Curb Weight			GAWR		HF	HM	HR	HE	HF	HM	HR	HE	A	B	C	D	E	F	G	H	J	K
		Frnt	Rr	Ttl	Frnt	Rr																		
6200 LT245/75R16	41.7	2710	1924	4634	3600	3750	17.6	19.4	28.9	29.5	15.9	16.8	25.3	25.4	14	26	31	23		17	15	20	24	29
6600 LT245/75R16	41.7	2725	1982	4707	3600	3750	17.8	19.5	29.0	29.4	16.0	17.0	25.5	25.3	14	26	32	23		18	16	20	24	29

K 20000 Models

K20753 141.5" Wheelbase		Frame Heights at Base Model Curb Weight				Frame Heights and Angular Dimensions are shown at Maximum GAWR Front and Rear																		
GVW/Tire	L	Base Model Curb Weight			GAWR		HF	HM	HR	HE	HF	HM	HR	HE	A	B	C	D	E	F	G	H	J	K
		Frnt	Rr	Ttl	Frnt	Rr																		
7200 LT245/75R16	36.8	2659	1818	4477	3750	4410	17.6	20.3	30.9	31.9	16.0	17.4	26.4	26.7	17	26	32	23		20	17	21	26	35

K20903 131.5" Wheelbase		Frame Heights at Base Model Curb Weight				Frame Heights and Angular Dimensions are shown at Maximum GAWR Front and Rear																		
GVW/Tire	L	Base Model Curb Weight			GAWR		HF	HM	HR	HE	HF	HM	HR	HE	A	B	C	D	E	F	G	H	J	K
		Frnt	Rr	Ttl	Frnt	Rr																		
7200 LT225/75R15	41.7	2500	1813	4313	3750	4670	17.3	20.0	30.4	31.4	15.6	16.8	25.6	25.9	17	25	31	22		20	16	20	25	30
8600 LT245/75R16	41.7	2775	1988	4763	3750	6000	17.4	20.1	30.6	31.7	16.3	16.9	24.9	24.8	17	27	32	24		17	15	19	23	28

K20906 131.5" Wheelbase		Frame Heights at Base Model Curb Weight				Frame Heights and Angular Dimensions are shown at Maximum GAWR Front and Rear																		
GVW/Tire	L	Base Model Curb Weight			GAWR		HF	HM	HR	HE	HF	HM	HR	HE	A	B	C	D	E	F	G	H	J	K
		Frnt	Rr	Ttl	Frnt	Rr																		
8600 LT245/75R16		2794	2847	5641	3750	6000	17.6	20.0	29.9		16.0	17.7	26.9		18	26	32	23	22		17	22	29	

K20953 155.5" Wheelbase		Frame Heights at Base Model Curb Weight				Frame Heights and Angular Dimensions are shown at Maximum GAWR Front and Rear																		
GVW/Tire	L	Base Model Curb Weight			GAWR		HF	HM	HR	HE	HF	HM	HR	HE	A	B	C	D	E	F	G	H	J	K
		Frnt	Rr	Ttl	Frnt	Rr																		
7200 LT245/75R16	41.7	2733	1923	4656	3750	4410	17.5	20.0	30.7	31.6	16.0	17.3	26.4	26.7	15	26	32	23		19	17	21	26	31
8600 LT245/75R16	41.7	3008	2148	5156	3750	6000	17.1	19.6	30.2	31.1	16.0	17.5	26.7	27.1	15	26	32	23		20	18	22	27	31

K 30000 Models

K30903		131.5" Wheelbase					Frame Heights at Base Model Curb Weight				Frame Heights and Angular Dimensions are shown at Maximum GAWR Front and Rear													
GVW/Tire	L	Base Model Curb Weight			GAWR		HF	HM	HR	HE	HF	HM	HR	HE	A	B	C	D	E	F	G	H	J	K
		Frnt	Rr	Ttl	Frnt	Rr																		
9200 LT245/75R16	41.7	2900	2125	5025	3750	6084	17.2	20.2	31.7	32.9	16.1	17.6	26.5	26.9	18	25	32	23		20	17	21	27	31
10000 LT225/75R16	41.7	2975	2376	5351	3750	7500	16.4	19.7	30.8	32.1	15.8	16.8	25.1	25.2	16	25	31	23		18	15	19	23	29

K30943		168.5" Wheelbase					Frame Heights at Base Model Curb Weight				Frame Heights and Angular Dimensions are shown at Maximum GAWR Front and Rear													
GVW/Tire	L	Base Model Curb Weight			GAWR		HF	HM	HR	HE	HF	HM	HR	HE	A	B	C	D	E	F	G	H	J	K
		Frnt	Rr	Ttl	Frnt	Rr																		
9200 LT245/75R16	41.7	3263	2417	5680	4500	6084	18.6	20.8	31.1	31.9	16.9	17.9	26.3	26.4	13	27	33	25		19	17	20	27	30
10000 LT225/75R16	41.7	3350	2253	5603	4500	7500	17.8	20.3	31.0	31.9	16.6	17.7	26.3	26.4	13	26	33	24		19	17	20	27	30

K30953		155.5" Wheelbase					Frame Heights at Base Model Curb Weight				Frame Heights and Angular Dimensions are shown at Maximum GAWR Front and Rear													
GVW/Tire	L	Base Model Curb Weight			GAWR		HF	HM	HR	HE	HF	HM	HR	HE	A	B	C	D	E	F	G	H	J	K
		Frnt	Rr	Ttl	Frnt	Rr																		
10000 LT225/75R16	41.7	3080	2247	5327	3750	7500	16.2	19.5	31.0	32.3	15.8	16.8	25.1	25.2	14	25	31	23		18	15	15	23	29

K31003		135.5" Wheelbase					Frame Heights at Base Model Curb Weight				Frame Heights and Angular Dimensions are shown at Maximum GAWR Front and Rear													
GVW/Tire	L	Base Model Curb Weight			GAWR		HF	HM	HR	HE	HF	HM	HR	HE	A	B	C	D	E	F	G	H	J	K
		Frnt	Rr	Ttl	Frnt	Rr																		
9200 LT245/75R16	51.0	2974	2012	4986	3750	6084	18.8	21.8	32.4	33.8	19.0	19.5	27.3	27.1	20	31	37	29	13	14	12		21	24
10000 LT225/75R16	51.0	2994	2338	5332	4500	7500	18.4	21.0	31.2	32.4	16.7	17.8	26.7	26.4	18	26	33	24	12	13	12		19	23
12000 LT225/75R16	51.0	3011	2387	5398	4500	8600	18.4	21.0	31.2	32.4	16.8	17.6	25.8	25.7	17	27	33	25	12	12	11		18	23

K31403		159.5" Wheelbase					Frame Heights at Base Model Curb Weight				Frame Heights and Angular Dimensions are shown at Maximum GAWR Front and Rear													
GVW/Tire	L	Base Model Curb Weight			GAWR		HF	HM	HR	HE	HF	HM	HR	HE	A	B	C	D	E	F	G	H	J	K
		Frnt	Rr	Ttl	Frnt	Rr																		
10000 LT225/75R16	51.0	3010	2051	5061	4500	7500	16.4	19.5	31.0	32.5	14.1	16.2	26.2	27.1	13	22	28	19	13	24	19		20	24
12000 LT225/75R16	51.0	3084	2490	5574	4500	8600	16.4	19.8	31.8	33.6	14.2	16.0	25.8	26.4	13	22	28	19	13	23	18		18	24

1994 GENERAL MOTORS CORPORATION

INFORMATION REGARDING

CONSUMER INFORMATION TRUCK-CAMPER LOADING

PUBLISHED MARCH 1993

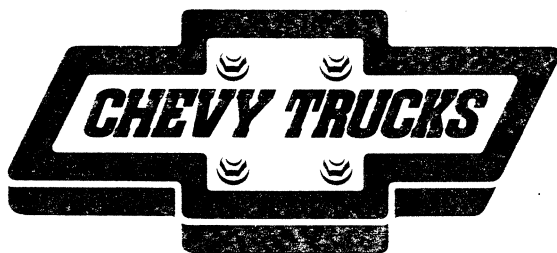

CHEVROLET MOTOR DIVISION
30007 VAN DYKE AVENUE
WARREN, MICHIGAN 48090



GMC TRUCK DIVISION
31 JUDSON STREET
PONTIAC, MICHIGAN 48342-2230

1994 GENERAL MOTORS TRUCKS

Consumer Information Truck - Camper Loading

CONSUMER INFORMATION REGULATION 575.103 issued by the National Highway Traffic Safety Administration requires manufacturers of trucks capable of accommodating slide-in camper bodies to provide information concerning proper load and proper load distribution in truck-camper applications.

This Consumer Information booklet is designed to provide basic information relating to load capabilities of 1994 General Motors truck models which are adaptable to slide-in camper applications. Information contained herein is applicable to the truck buyer who already owns a 1994 General Motors truck or to a prospective truck purchaser.

The Regulation also provides that proper truck-camper loading information is to be maintained in truck dealerships and be made available to all prospects on request. This booklet relates to the 1994 General Motors truck models recommended for slide-in camper applications and is to be used as a consumer information brochure.

Product specifications or data contained herein may change periodically. When a revision of this booklet is supplied to truck dealers, it is the dealers' responsibility to make the revised information available to the public.

Chevrolet's and GMC's 1988 and newer Full-Size C/K Pickups feature a styling that is more aerodynamic than prior models. Aftermarket manufacturers offer many products, such as slide-in campers, camper shells, and bedliners, designed to fit on the new pickups. However, some products designed for use on Chevrolet Full-Size Pickups, built prior to the 1988 model year or R-V models through the 1991 model year, may not fit in the bed of this vehicle. Please confirm the compatibility of any aftermarket product you intend to install on your new truck by consulting the product manufacturer.

Chevrolet's and GMC's 1994 S/T Series Pickups feature new styling that is more aerodynamic than models from previous years. Some aftermarket items designed for 1993 and earlier S/T Series Pickups may not fit in the bed of this new vehicle. Please consult the product manufacturer for compatibility prior to purchase.

All illustrations and specifications contained in this literature are based on the latest product information available at the time of publication approval. The right is reserved to make changes at any time in prices, colors, materials, equipment, specifications and models, and also to discontinue models.

TRUCK - CAMPER LOADING

Consumer Information Regulation 575.103 requires manufacturers of trucks capable of accommodating slide-in campers to specify the vehicles' Cargo Weight Rating (CWR) and the longitudinal limits within which the center of gravity for the cargo weight rating should be located.

Cargo Weight Rating (CWR)—The cargo weight rating of a vehicle means the value specified by the vehicle manufacturer as the cargo-carrying capacity of a vehicle in pounds, exclusive of (minus) the weight of occupants, computed as 150 pounds times the number of designated seating positions.

Longitudinal Center of Gravity (CG) Zone for CWR—The forward limit of the recommended CG Zone is determined by the application of dimension "A" measured in inches from the rear of the truck bed. The rearward limit of the recommended CG Zone is established by application of dimension "B", also measured in inches from the rear of the truck bed. The recommended CG Zone lies between these points.

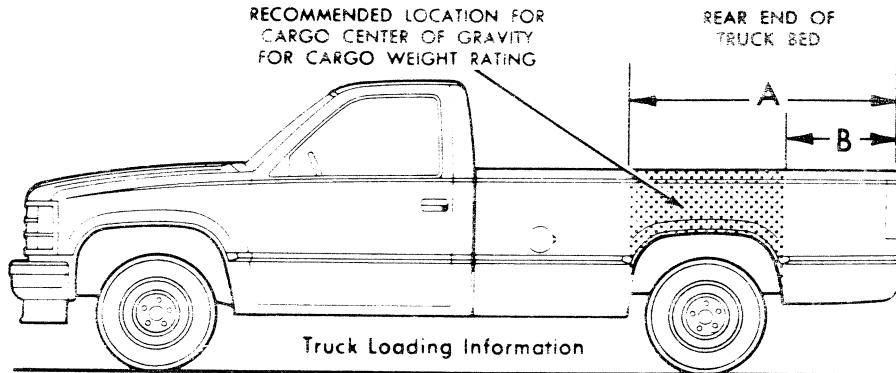

Model _____ Calculated
Cargo Weight Rating _____

Dimension A _____ Dimension B _____

Limitations on Recommended CG Zones

FORWARD LIMIT

- (1) Must not extend beyond the inside surface of the pickup box. (2) Must not exceed the front gross axle weight rating (GAWR).

REARWARD LIMIT

- (1) Must be no farther rearward than the inside surface of the pickup box. (2) Must not exceed the gross axle weight rating (GAWR) of the rear axle. (3) Must not exceed rear axle load limits below:

Series	Rear Axle Load Limits (% of GVWR)
S/T-10/15	62%
C/K 1500	60%
C/K 2500	65%
C/K 2500/C6P, C/K 3500	70%

Vehicle CG Identification—All General Motors Corporation trucks that may be suitable for carrying a slide-in camper incorporate a Truck-Camper Loading information label located on the glove box floor on C/K and S/T-10/15 models. The vehicle identification number (VIN), the as-manufactured cargo weight rating (CWR) of that vehicle plus the CG limits of dimension "A" and "B" for that vehicle in inches are included.

Vehicle and Truck-Camper Loading are also discussed at length in the Vehicle Owner's Manual.

TRUCK - CAMPER LOADING

Loading Instructions—When the truck is used to carry a slide-in camper, the total cargo load of the truck consists of the manufacturer's camper weight figure, the weight of installed additional camper equipment not included in the camper manufacturer's weight figure, the weight of camper cargo, and the weight of passengers in the camper. The total cargo load should not exceed the truck's cargo weight rating (CWR) and the camper's center of gravity should fall within the truck's recommended center of gravity zone when installed.

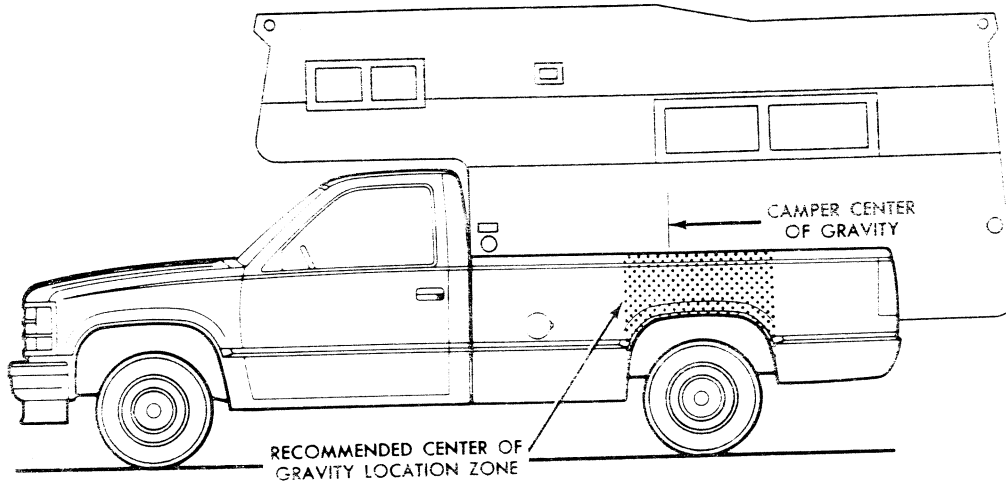

Any accessories or other equipment added to this vehicle, after final date of manufacture, must be weighed or have their weight determined, and the weight deducted from the prescribed cargo weight rating (CWR) of this vehicle. This may decrease the permissible longitudinal zone of the center of gravity for this vehicle.

The longitudinal center of gravity zone has been determined for the full cargo weight rating of this truck. If a slide-in camper has a total weight less than the cargo weight rating (CWR), the permissible longitudinal zone of the center of gravity may be larger. However, individual axle loads should not exceed either of the gross axle weight ratings (GAWR).

Secure loose items to prevent weight shifts that could affect the balance of your vehicle. When the truck camper is loaded, drive to a scale and weigh on the front and on the rear separately to determine the axle loads. Individual axle loads should not exceed either of the gross axle weight ratings (GAWR). The total of the axle loads should not exceed the gross vehicle weight rating (GVWR). These ratings are given on the vehicle identification plate and on the vehicle certification label which are located on the left side of the vehicle, normally on the door latch post or door edge next to the driver. If weight ratings are exceeded, move or remove items to bring all weights below the ratings.

CAUTION: The longitudinal center of gravity is only one of the many factors which may affect the overall performance of a vehicle, including handling, steering and braking. The cargo load should be distributed on both sides of the centerline as equally as possible. The recommended longitudinal limits for the camper's center of gravity are based on the assumption that the vehicle will be operated with reasonable prudence in light of all of the existing conditions. Failure to do so could result in unsatisfactory vehicle performance and could make the vehicle unsafe to operate.

In this connection, refer to any recommendations by the slide-in camper manufacturer regarding installation and loading of the camper.

TRUCK – CAMPER LOADING

DEFINITION OF TERMS

For the purposes of calculating Truck-Camper Loading in this book, listed below are some common terms and abbreviations:

Cargo Weight Rating (CWR)—means the value specified by the vehicle manufacturer as the cargo-carrying capacity of a vehicle in pounds, exclusive of (minus) the weight of occupants, computed as 150 pounds times the number of designated seating positions.

Center of Gravity (CG)—Point where the mass of a body is concentrated and if suspended at that point would balance front and rear.

Curb Weight – Weight of a vehicle without driver, passengers or cargo but including maximum capacity of fuel, oil, coolant and other items of standard equipment.

Dimension A & B—Front and rear limit of Center of Gravity (CG) zone.

Gross Vehicle Weight Rating or “GVWR” means the value specified by the manufacturer as the loaded weight of a single vehicle.

Gross Axle Weight Rating or “GAWR” means the value specified by the vehicle manufacturer as the load carrying capacity of a single axle system measured at the tire-ground interfaces.

Model Weight—Weight of the vehicle with all items of standard equipment, 150 pounds per passenger in each designated seating position and maximum capacity of fuel, oil and coolant.

Payload Rating—is the maximum allowable load (including the weight of the driver and all occupants) that the vehicle can carry based on all factory-installed equipment on the vehicle.

RPO—Regular Production Option.

Slide-in Camper—means a camper having a roof, floor, and sides, designed to be mounted on and removable from the cargo area of a truck by the user.

Weight Distribution—The amount of a vehicle’s weight that rests on each axle.

Wheelbase (WB)—The distance from the centerline of the front axle to the centerline of the rear axle.

LIMITATIONS

The following General Motors truck models are not recommended for slide-in camper applications:

- Any pickup model with a cargo weight rating (CWR) of less than 500 lbs. A statement to this effect is imprinted on the Truck-Camper Loading information label which states whether that vehicle is recommended for use with a slide-in camper.
- S-10/15 (2WD) Pickup with 4200 lb. GVWR.
- T-10/15 (4x4) Pickup with 4650 lb. GVWR.
- S/T-10/15 Pickup with 108.3” WB.
- S/T-10/15 Extended Cab Pickup.

Note: C/K 1500 Pickups should not be used for larger, cab-over type slide-in campers.

TRUCK – CAMPER LOADING

S/T PICKUPS, C/K PICKUPS, EXTENDED/CLUB AND CREW CAB PICKUPS

INSTRUCTIONS FOR PROSPECTIVE TRUCK PURCHASERS **VEHICLE SELECTION AND WEIGHT ANALYSIS**

1. For S/T-10/15 Models.

You must order S/T 10803 (117.9" WB) model with one of the following GVWR Ratings:

S10803 (2WD)	4600 lb.	GVWR
S10803 (2WD)	4900 lb.	GVWR
T10803 (4x4)	5150 lb.	GVWR

if you intend to use a slide-in camper on your S/T-10/15 Pickup. Record the model on page 3. Record the model GVWR, front GAWR, and rear GAWR on page 7. These ratings can be found in the S/T-10/15 section of the General Motors Light-Duty Truck Data Book or Chevrolet Light-Duty Technical Guide on the Specifications pages. This information is also available in the Chevrolet Spec Manager computer program.

For C/K Models.

From the model selection pages of the C/K Pickup section of the GMC Light-Duty Truck Data Book, Chevrolet Light-Duty Technical Guide or the Chevrolet Spec Manager System, select the pickup model you desire. Record this information on page 3. Refer to the Specification section for the selected model. Select the GVWR you require and note any minimum tire size and chassis equipment requirements for that GVWR. (To approximate the GVWR you require, add your loaded camper weight to the vehicle curb weight plus the occupants weight at 150 lbs. per designated seating position.) Record this GVWR and the Gross Axle Weight Rating (GAWR), Front and Rear (from the Specifications section), on line 1 of the camper loading worksheet, page 7.

2. Record the front and rear curb weights of your selected vehicle on line 2, page 7.
3. Record the front and rear passenger weights on line 3, page 7.
4. List all factory-installed options you desire, including any options required by your selected GVWR, with their front and rear weights on the Pickup camper loading worksheet on page 7.
5. Total the front and rear weights of vehicle model and options to arrive at the total front and rear weight of the vehicle. Follow the directions on page 7, lines 5 through 5C to arrive at the adjusted total vehicle weight.
6. Subtract the adjusted total vehicle weight from the GVWR to arrive at the cargo weight rating (CWR) of your truck.* Record this information on page 3.
7. Proceed to page 11 and calculate the center of gravity location limits using front and rear GAWRs, cargo weight rating (CWR), and front and rear weight of truck as determined above. Record this information on page 3.

*The addition of any dealer-installed or other accessories will reduce the cargo-carrying capacity by the weight of the equipment installed.

**TRUCK-CAMPER LOADING
S/T PICKUPS, C/K PICKUPS
WORKSHEET-CARGO WEIGHT RATING**

1. Model GVWR _____	GAWR	FRONT _____	REAR _____
2. Curb Weights:		FRONT _____	REAR _____
3. Passenger Weights:		FRONT _____	REAR _____
4. Other factory-installed options:			
.....		_____	_____
.....		_____	_____
.....		_____	_____
.....		_____	_____
.....		_____	_____
.....		_____	_____
.....		_____	_____
.....		_____	_____
.....		_____	_____
.....		_____	_____
4a.		TOTALS _____	_____

5. **Front and Rear Weight:** _____

5a. **Vehicle sub-total weight** (add front and rear weight): _____

5b. **Add 50 lbs. for all models*** _____ + 50.

5c. **Adjusted total vehicle weight:** _____

6. **Vehicle GVWR:** _____

Adjusted total vehicle weight (_____)

Cargo Weight Rating _____

Record on page 3.

*If your vehicle is available, drive to a scale and weigh, with occupants, full fuel tank, and other factory-installed options to determine the adjusted total vehicle weight. You will then be able to use your actual total vehicle weight and not have to add the 50#.

TRUCK - CAMPER LOADING DIMENSIONS

S-10/15 PICKUPS

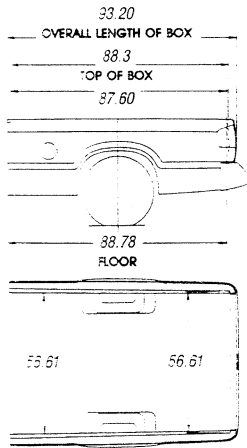

LONG BOX (MODEL S/T10803)

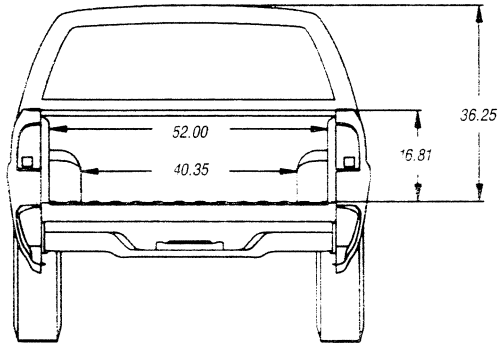

C/K PICKUPS

FLEETSIDE/WIDESIDE SHORT BOX (MODELS C/K10703, C/K10753, C/K20753)

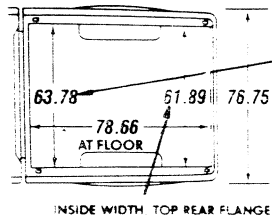
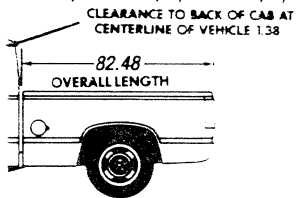

FLEETSIDE/WIDESIDE LONG BOX

(MODELS C/K10903, C/K20903, C/K30903, C/K10953, C/K20953, C/K30943, C/K30953)

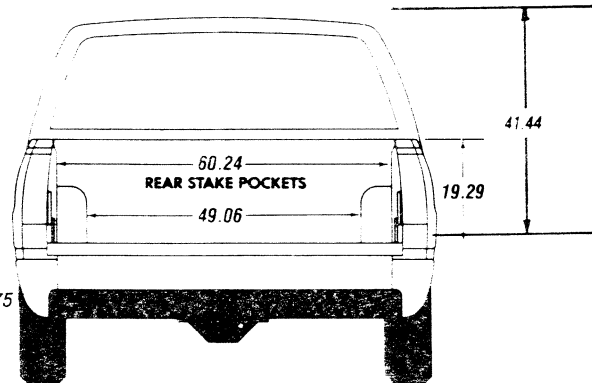
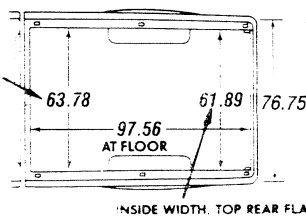
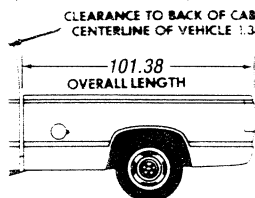

C/K REGULAR CAB PICKUPS

(MODELS C/K10703)

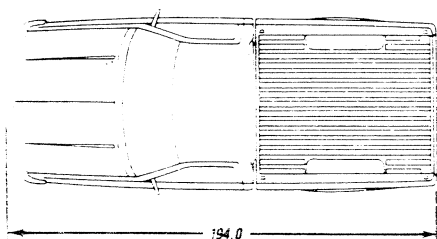
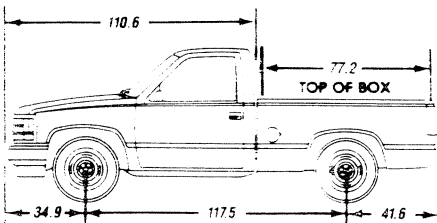

(MODELS C/K10903, C/K20903, C/K30903)

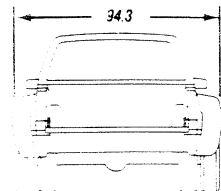
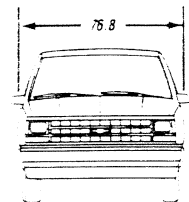
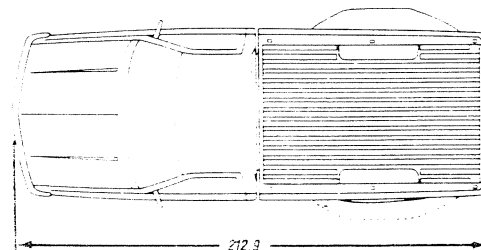
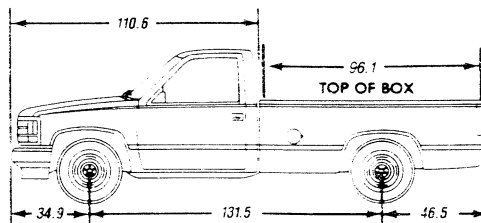

TRUCK - JAMPER LOADING

DIMENSIONS

C/K PICKUPS

SPORTSIDE SHORT BOX

(MODELS C/K 10703, C/K 10753 [E62])

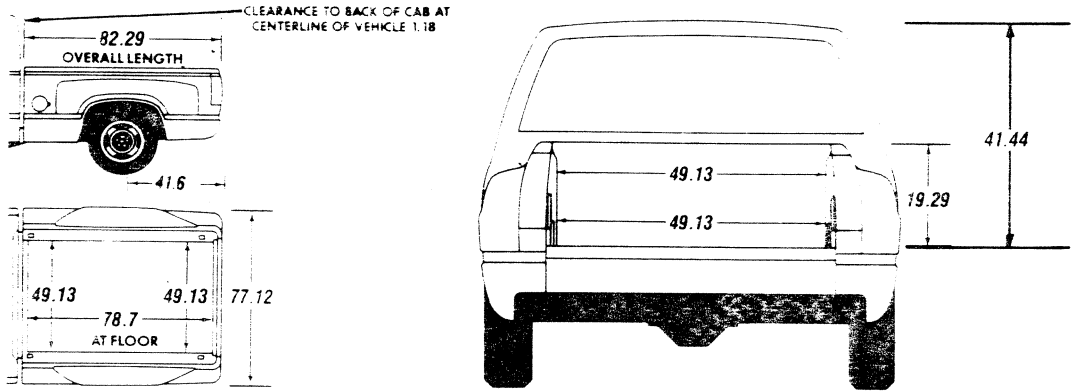

C/K EXTENDED/CLUB CAB PICKUPS

FLEETSIDE/WIDESIDE

(MODELS C/K10753, C/K10953, C/K20753, C/K20953, C/K30953)

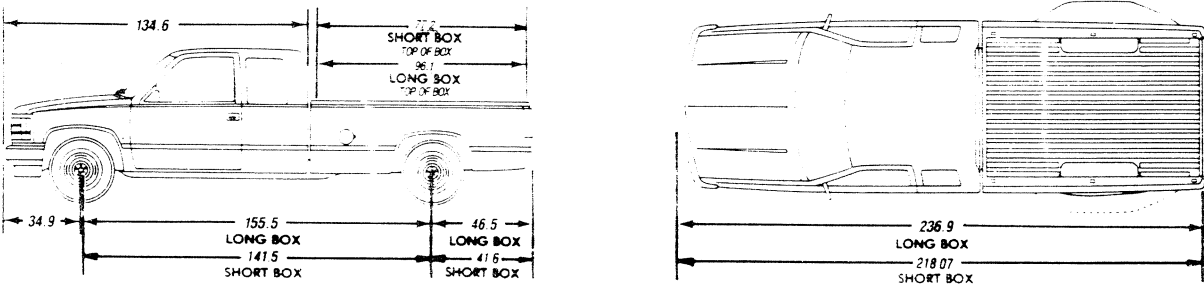

C/K CREW CAB PICKUPS

FLEETSIDE/WIDESIDE LONG BOX

(MODELS C/K30943)

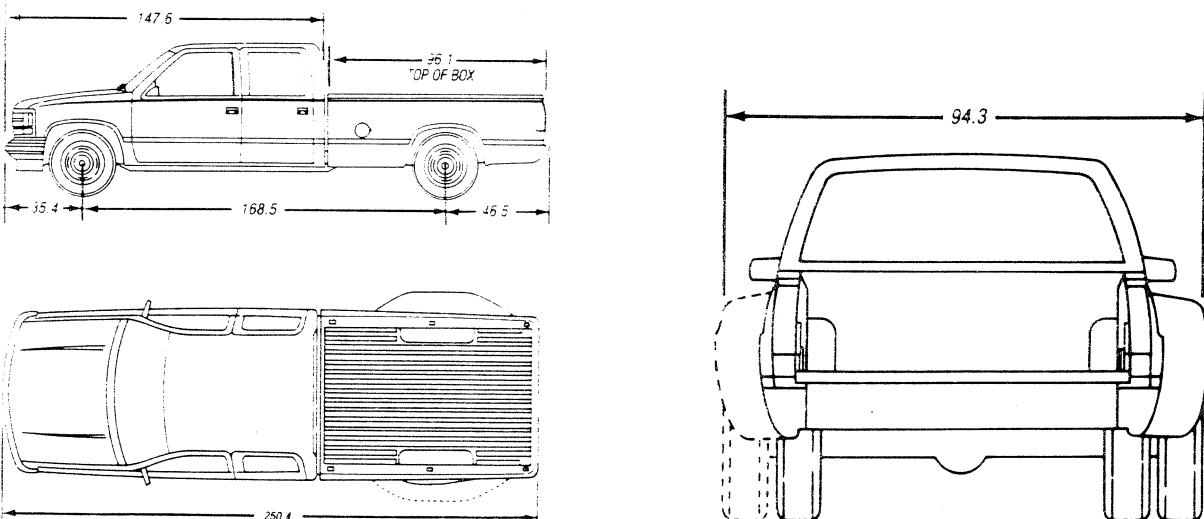

TRUCK - CAMPER LOADING

MODEL CODES AND DIMENSIONS

SERIES	MODEL NUMBER	PICKUP BOX LENGTH	PICKUP STYLE	WB	"C"*
REGULAR CAB MODELS					
S/T-10/15	S/T10803	7 ¹ / ₂ '	Fleetside/Wideside (E63)	117.9"	43.40"
C/K1500	C/K10703	6 ¹ / ₂ '	Fleetside/Wideside (E63)	117.5"	38.70"
			Sportside (E62)	117.5"	38.61"
	C/K10903	3'	Fleetside/Wideside (E63)	131.5"	43.57"
C/K2500	C/K20903	3'	Fleetside/Wideside (E63)	131.5"	43.57"
C/K3500	C/K30903	3'	Fleetside/Wideside (E63)	131.5"	43.57"
EXTENDED/CLUB CAB MODELS					
C/K1500	C/K10753	6 ¹ / ₂ '	Fleetside/Wideside (E63)	141.5"	38.70"
			Sportside (E62)	141.5"	38.61"
	C/K10953	3'	Fleetside/Wideside (E63)	155.5"	43.57"
C/K2500	C/K20753	6 ¹ / ₂ '	Fleetside/Wideside (E63)	141.5"	38.70"
	C/K20953	3'	Fleetside/Wideside (E63)	155.5"	43.57"
C/K3500	C/K30953	3'	Fleetside/Wideside (E63)	155.5"	43.57"
CREW CAB MODEL					
C/K3500	C/K30943	3'	Fleetside/Wideside (E63)	155.5"	43.57"

*Dimension "C" is the distance from the centerline of the rear axle to the end of the pickup box floor.
 Dimensions A and B can be calculated by using the formula on page 11.

REGULAR CAB S-10/15 PICKUPS

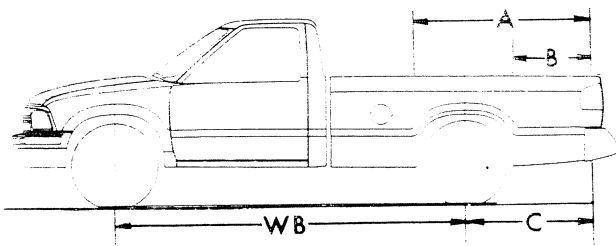

EXTENDED CAB C/K PICKUPS

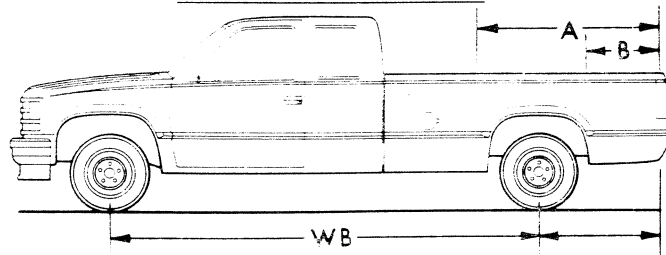

REGULAR CAB C/K PICKUPS

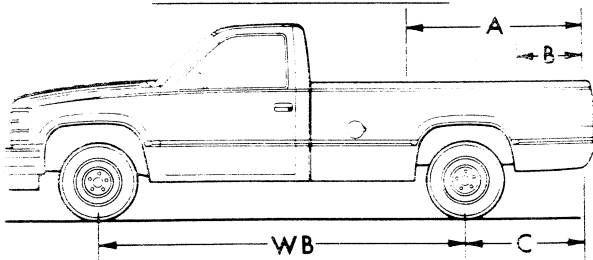

CREW CAB C/K PICKUPS

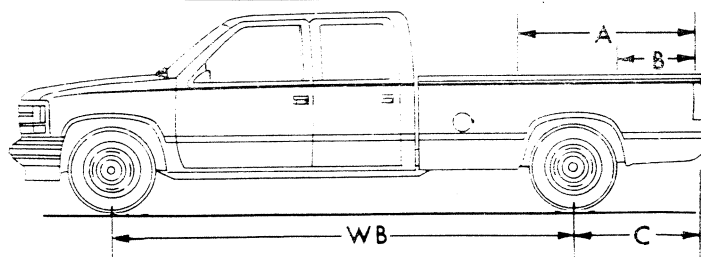

TRUCK – CAMPER LOADING

CALCULATIONS TO DETERMINE FORWARD (A) AND REARWARD (B) LOCATION OF CENTER OF GRAVITY FOR CARGO WEIGHT RATING

Calculations for Dimension A

$$A = \left\{ \frac{\text{Front GAWR} - 1.05 \times \text{Front Weight of Truck}}{\text{Cargo Weight Rating}} \right\} \times WB + C$$

Enter Front GAWR _____

Subtract Front Weight of Truck x 1.05 _____ - (_____)

Answer _____

Divide Answer by Cargo Weight Rating (CWR) _____ ÷ _____

Answer _____

Multiply Answer by Wheelbase _____ x _____

(See Chart on Page 10)

Answer _____

Add C Dimension to Answer _____ + C _____

(See Chart on Page 10)

Dimension A = _____

Note: If "A" is greater than pickup box length, use box length for "A" dimension.

Calculations for Dimension B

$$B = \left\{ 1 - \frac{\text{Rear GAWR} - 1.1 \times \text{Rear Weight of Truck}}{\text{Cargo Weight Rating}} \right\} \times WB + C$$

Enter Rear GAWR _____

Subtract Rear Weight of Truck x 1.1 _____ - (_____)

Answer _____

Divide Answer by Cargo Weight Rating (CWR) _____ ÷ _____

Answer _____

Subtract Answer from 1.000 _____ - (_____)

Multiply Answer by Wheelbase _____ x _____

Answer _____

Add C Dimension to Answer _____ + C _____

Dimension B = _____

Note: If "B" dimension is negative, use 0 (zero) for "B" dimension.

If "B" dimension is greater than "A" dimension, camper usage is not recommended at the Calculated Cargo Weight Rating. Camper usage may be possible for a lighter camper. Substitute known specific camper weight (less than Cargo Weight Rating) for Cargo Weight Rating in calculations above to determine "A" to "B" range for that specific camper.

Record dimension A and B on page 3.

*From page 7 line 4a.



CHEVROLET MOTOR DIVISION
30007 VAN DYKE AVENUE
WARREN, MICHIGAN 48090



GMC TRUCK DIVISION
31 JUDSON STREET
PONTIAC, MICHIGAN 48342-2230

