

CHEVROLET

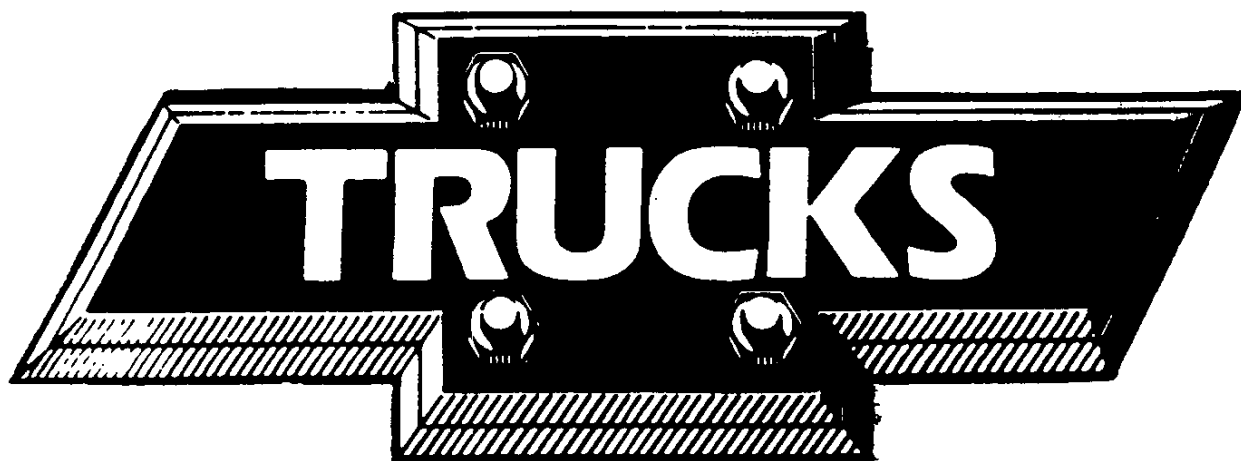

1997



10

1





The Brief

Chevy Trucks Shine at Olympics

Traditionally, the Olympic Games are a venue for athletes to shine. But at the recent Atlanta games, Chevy Trucks shined too.

For the opening ceremonies, 30 C/K Pickups were used to bring dancers onto the field at Olympic Stadium, as well as perform a few "coreographed" moves of their own. Each of the pickups wore a special chrome finish over its entire exterior. Because chrome-plating an entire pickup would have made the vehicle prohibitively heavy, each was instead covered with a chrome-finish appliqué.

"The trucks were an integral part of the Opening Ceremonies and provided a great way for Chevy to break through the marketing barrier of the Olympics," says Cynthia Babcock, assistant manager, passenger car Events and Sponsorship.

The chrome finish was developed by GM North American Operations Prototype Design and 3M. Several shifts of Chevrolet/Geo employees took nearly a month to cover each of the 30 special C/Ks. With the conclusion of the Olympics, the unique trucks will stay in the limelight a little longer. Some will tour various farm shows throughout the country and a couple will appear at various Chevrolet functions. Eventually, the majority of the trucks will be stripped of their chrome appliqués and auctioned off (each vehicle will come with a certificate of authenticity stating it was one of the chromed Olympic trucks).

.

.

.



C/K Pickup and Crew-Cab

Dealer Order Guide inserts are your first look at Chevrolet Truck models for 1997. Overall improvements, changes and deletions are highlighted. Use these inserts to assist you in ordering your initial shipments. NOTE: some information is preliminary and is subject to change.

Positioning Statement

The dependable, full-size pickup that's built for tough, rugged use.

Crew-Cab is the ideal truck for transporting up to six people in solid comfort.

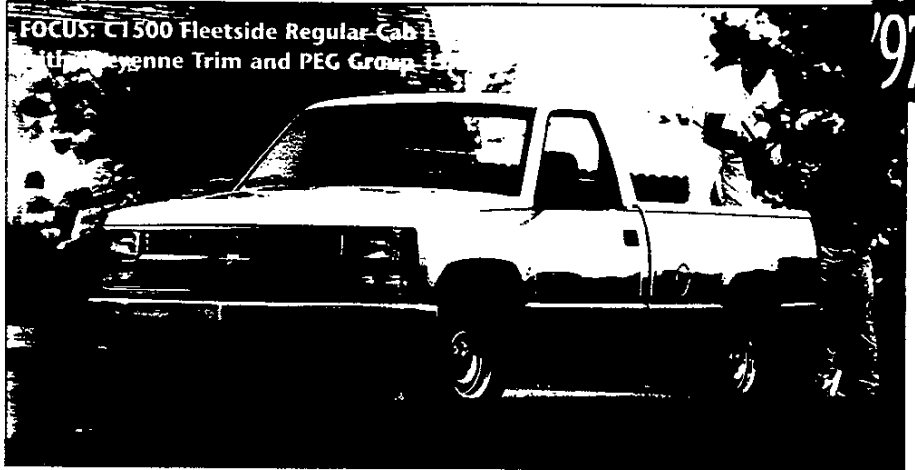

FOCUS: C1500 Fleetside Regular-Cab with Cheyenne Trim and PEG Group 1SA

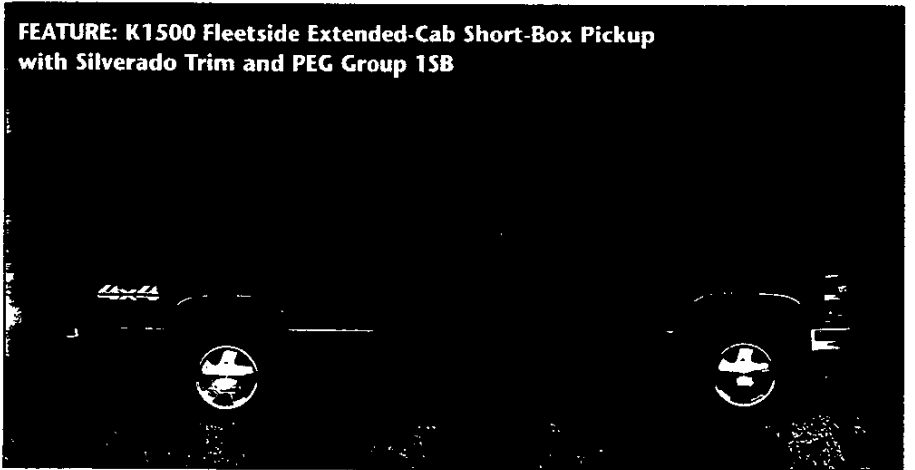

FEATURE: K1500 Fleetside Extended-Cab Short-Box Pickup with Silverado Trim and PEG Group 1SB

FOCUS

The Focus vehicle is the model chosen for its saleability. It is equipped with the product features that customers want most. Generally, it is the "volume" vehicle that comprises the majority of the total. You'll want to be sure you have several of these models in stock. NOTE: model, PEG and optional equipment may vary in your location.

C1500 Fleetside Regular-Cab Long-Box Pickup with Cheyenne Trim and PEG Group 1SA

(image above, top)

The Focus vehicle for 1997 is the C1500 Fleetside Regular-Cab Long-Box Pickup with Cheyenne trim and Preferred Equipment Group 1SA. This vehicle is engineered to outperform driver expectations.

Ordering Recommendations:

The recommended C1500 Fleetside Regular-Cab Long-Box Pickup with Cheyenne content, based on national sales volume, is listed below to assist your dealership in ordering.

C1500 Fleetside Regular-Cab Long-Box Pickup with Cheyenne trim with Preferred Equipment Group 1SA includes:

- Cheyenne Decor
- AM/FM Stereo with Seek-Scan and Digital Clock.

FEATURE

The Feature vehicle is the "image" model Chevy Truck will profile most in its advertising. Generally, it does the best job of capturing attention and creating consumer awareness.

K1500 Fleetside Extended-Cab Short-Box Pickup with Silverado Trim and PEG Group 1SB

(image above, bottom)

The 1997 C/K Pickup Feature vehicle is the K1500 Fleetside Extended-Cab Short-Box Pickup with Silverado Preferred Equipment Group 1SB. This C/K Pickup model also has the available third door and a comfortable passenger cab, while Silverado trim enhances the interior and exterior appeal for an attractive, versatile truck.

In addition to or replacing items in Cheyenne decor, the Silverado model includes:

- Silverado Decor (YE9) — includes bright deluxe grille with dual composite halogen headlamps
- Air Conditioning
- AM/FM Stereo with Seek-Scan, Automatic Tone Control, Digital Clock and Cassette Player
- Tilt-Wheel™ Adjustable Steering Column and Electronic Speed Control
- Power Windows and Power Door Locks
- Body-Side Moldings.

C/K Truck and Crew-Cab

'97

Trim Colors and Seat Styles



Vinyl available in Neutral, Blue, Gray and Red.

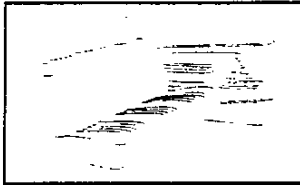

Bench seat —
WT1500 and Cheyenne.



Reclining split-bench seat —
Extended-Cab.

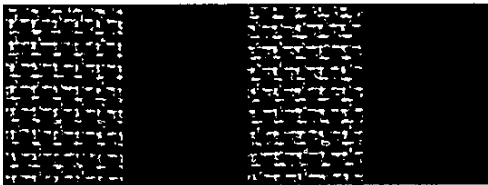

Cloth available in Neutral, Blue, Gray and Red.

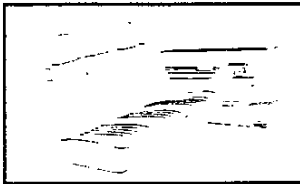

Bench seat —
Regular-Cab.

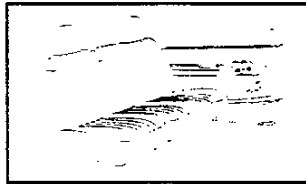

Reclining high-back bucket seats —
Extended-Cab.

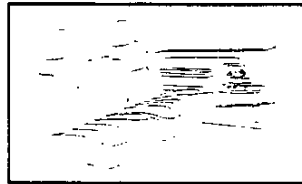

Reclining 60/40 split-bench seat —
Silverado.



Custom Cloth available in Neutral, Blue, Gray and Red.

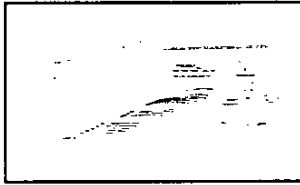

Reclining bench seat —
Silverado Regular-Cab.

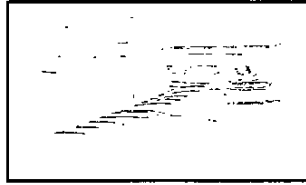

Reclining 60/40 split-bench seat —
Silverado.

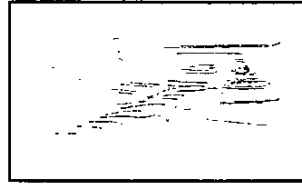

Reclining high-back bucket seats —
Silverado.



Custom Leather seating surfaces available in
Neutral, Blue, Gray and Red — all models.

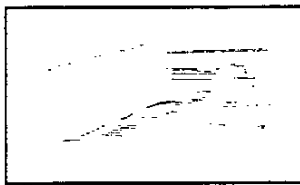

Reclining bench seat —
Silverado Regular-Cab.

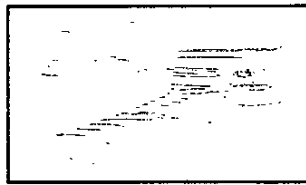

60/40 split-bench seat —
Silverado.

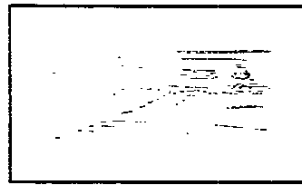

Reclining high-back bucket seats —
Silverado.

C/K Pickup and Crew-Cab

Wheels

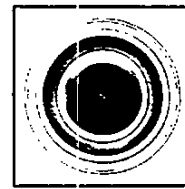

Standard 15" or
16" steel painted
silver with black
hub ornament
— W/T1500,
Cheyenne (Base).



(RPO P06) 15" or
16" Rally Wheel
trim — standard
on Silverado,
optional on
Cheyenne (Base).



Standard 16" front
wheel for 3500
Series when
equipped with
dual rear wheels.

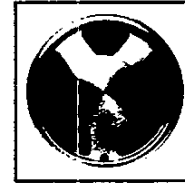

(RPO N90)
Optional 15"
cast-aluminum
— C1500.

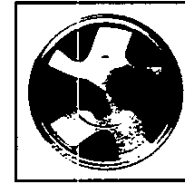

(RPO PF4)
Optional 16"
cast-aluminum
— K1500.

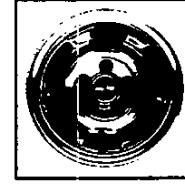

(RPO N83)
Optional chrome-
plated wheel
with chrome
hub ornament
— C1500 Series
only.



C/K Pickup and Crew-Cab

'97

Most Popular Exterior Colors with Corresponding Interior Color Availability

C/K Pickup

INTERIOR MATERIAL COLORS

	Neutral	Blue	Gray	Red
EXTERIOR COLORS				
Emerald				
Green Metallic	✓		✓	
Summit				
White	✓	✓	✓	✓
Victory				
Red	✓		✓	

Crew-Cab

INTERIOR MATERIAL COLORS

	Neutral	Blue	Gray	Red
EXTERIOR COLORS				
Emerald				
Green Metallic	✓		✓	
Onyx				
Black	✓		✓	✓
Summit				
White	✓	✓	✓	✓
Victory				
Red	✓		✓	

Most Popular Exterior Colors by Percentage

Below clockwise are the anticipated most popular C/K Pickup and Crew-Cab colors for 1997, based on national sales volume. They are listed for reference only. To identify the top-selling colors in your area, by model, use the Retail Sales Analysis (RSA).

C/K Pickup

Summit White	22%
Emerald Green Metallic	15%
Dark Carmine Red Metallic	11%
Victory Red	11%
Other colors	41%

Crew-Cab

Summit White	40%
Onyx Black	11%
Emerald Green Metallic	10%
Victory Red	10%
Other colors	29%

Competitive Models

- Ford F-Series
- Dodge Ram
- Toyota T-100.

Additional Information on Significant Features

- An important addition this year is the standard front-passenger air bag.* Since safety is a major consideration among today's buyers, the front-passenger air bag helps makes Chevy C/K Pickup more competitive in the full-size market segment.

*Included on models with GVWRs under 8600 lbs. only.

- New natural gas vehicle (KL6). Municipalities and fleets are placing increased emphasis on alternative fuel systems, and this model helps answer the call. Available only with an 8600-lb. GVW (C6P) with Vortec 5700 V8, 4L80-E automatic transmission and 3.73 rear axle ratio, this newcomer should have wide appeal. Available on C2500 Fleetside model only. Order RPO KL6.

- New manual transmission (MW3). All C/K2500 models at or above 8600 lb. GVWR and all C/K3500 models get added sales appeal, thanks to this improved manual transmission. Features include quieter operation and improved shift feel. Added torsional damping is a big plus for models equipped with diesel engines.

- New 4WD improved turning radius (K1500 gasoline models only). Maneuverability is important to four-wheel-drive aficionados, and especially off-road enthusiasts. This new system uses revised components and increased turn angles to make possible a shorter turning radius. Affects all 4WD 1500 Series models except diesel.

- New Electronic Variable Orifice steering, standard on all models, reduces low speed and static steering effort while maintaining steering effort and road feedback at highway speeds.

Deletions

- Three exterior colors have been deleted for 1997: Indigo Blue Metallic (#39), Dark Garnet Red Metallic (#84) and Bright Teal Metallic (#38) and have been replaced by three new colors: Medium Royal Blue Metallic (#25), Medium Blue-Green Metallic (#35) and Dark Carmine Red Metallic (#51).



C/K Pickup and Crew-Cab

P.D.S.E.I. helps explain 1997 models for this brand. Overall improvements, changes and deletions are highlighted. Please review the supplied information, keeping in mind that this material is provided to you before production startup — and may change.

P.D.S.E.I. (New-for-'97 features appear first and in color.)



PERFORMANCE

• **MANUAL TRANSMISSION (MW3)** — All C/K2500 models above 8600 lb. GVWR and all C/K3500 models gain improved shift feel and quieter operation compared to last year's transmission. • **AVAILABLE NATURAL GAS MODEL (8600 LBS. GVW, VORTEC 5700 V8 ENGINE ONLY)** — allows bifuel capability. • **SHORTER TURNING RADIUS FOR 4WD 1500 SERIES MODELS (EXCEPT DIESEL MODELS)** — provides shorter turning radius for easier maneuvering. • **ELECTRONIC VARIABLE ORIFICE STEERING** — reduces low speed and static steering effort, yet maintains effort level and road feedback at highway speeds. • **STANDARD VORTEC 4300 V6 L35 ENGINE WITH SEQUENTIAL FUEL INJECTION (SFI)** — provides impressive power, smooth, quiet performance and extended maintenance intervals. • **AVAILABLE DIESEL POWER** — eager 6.5 Liter Turbo-Diesel V8 is available in most C/K Pickup models. An ideal choice for fleets and trailer towing.



DURABILITY

• **100,000-MILE SPARK PLUGS** — for extended service intervals.* • **SERPENTINE BELT ACCESSORY DRIVE** — designed to last 100,000 miles. • **NO NEED TO CHECK ENGINE TIMING** — ever. • **TWO-SIDE-GALVANIZED STEEL** — on all exterior body panels (except roof), providing maximum corrosion protection. • **BUMPER TO BUMPER LIMITED WARRANTY** — protection for 3 years or 36,000 miles, with no deductible.

*Warranty needs vary with different uses and driving conditions.



SAFETY

• **PASSENGER AIR BAG*** — added safety for front-seat passengers. Always wear safety belts, even with air bags. • **CHILD SECURITY REAR-DOOR LOCK SYSTEM FOR CREW-CAB MODELS** — when engaged prevents the rear doors from being opened from the inside. • **DRIVER AIR BAG*** — helps reduce the chance of injury in certain moderate to severe frontal collisions. • **4-WHEEL ANTI-LOCK BRAKE SYSTEM (ABS)** — helps maintain steering control and minimizes wheel lockup on most slippery surfaces. • **STANDARD DAYTIME RUNNING LAMPS** — help make vehicle more visible during daylight hours.

*On vehicles under 8600 lbs. GVW.



EXTERIOR

• **BASECOAT/CLEARCOAT PAINT** — resists fading and provides a high-gloss shine, for long-lasting exterior beauty. • **ANTI-CHIP FEATURE** — color-keyed primer surfacer helps prevent damage to finish. • **TRIM LEVELS** — choice of Cheyenne or Silverado trim levels.



INTERIOR

• **OPTIONAL EXTENDED-CAB THIRD DOOR (C/K1500 SERIES ONLY)** — makes entry and exit from rear seat easy. • **AVAILABLE CUSTOM LEATHER SEATING SURFACES (SILVERADO ONLY)** — Bring the luxury of real leather to Regular-, Extended- and Crew-Cab models. • **EXTENDED-CAB FOLD DOWN REAR SEAT** — rear seatback folds down to make handy load shelf, lower cushion folds up for added storage area. • **SCOTCHGARD™ PROTECTOR** — on cloth seats, door panels and floor carpeting, resists stains for easy cleanup.



C/K Pickup and Crew-Cab

'97

Forecasted Percent of Mix

Regular-Cab 35%

C/K1500	78%
C/K2500	3%
C/K2500 HD	7%
C/K3500	12%
TOTAL MODELS	100%

	C/K 1500	C/K 2500	C/K 2500HD	C/K 3500
Long Wheelbase	50%	100%	100%	100%
Short Wheelbase	50%	NA	NA	NA
TOTAL	100%	100%	100%	100%
Sportside Box	25%	NA	NA	NA
Fleetside Box	75%	100%	100%	100%
TOTAL	100%	100%	100%	100%
Work Truck	35%	NA	NA	NA
Cheyenne	15%	65%	60%	45%
Silverado	50%	35%	40%	55%
TOTAL	100%	100%	100%	100%
4-Speed Automatic	80%	80%	75%	65%
5-Speed Manual	20%	20%	NA	NA
5-Speed HD Manual	NA	NA	25%	35%
TOTAL	100%	100%	100%	100%
Vortec 4300 V6*	66%	0%	NA	NA
Vortec 5000 V8	25%	25%	NA	NA
Vortec 5700 V8	6%	65%	77%	58%
6.5L Turbo-Diesel	3%	10%	23%	28%
Vortec 7400 V8	NA	0%	0%	14%
TOTAL	100%	100%	100%	100%

Extended-Cab 65%

C/K1500	85%
C/K2500	2%
C/K2500 HD	11%
C/K3500	2%
TOTAL MODELS	100%

	C/K 1500	C/K 2500	C/K 2500 HD	C/K 3500
Long Wheelbase	5%	0%	70%	100%
Short Wheelbase	95%	100%	30%	NA
TOTAL	100%	100%	100%	100%
Sportside Box	15%	NA	NA	NA
Fleetside Box	85%	100%	100%	100%
TOTAL	100%	100%	100%	100%
Work Truck	NA	NA	NA	NA
Cheyenne	4%	10%	15%	5%
Silverado	96%	90%	85%	95%
TOTAL	100%	100%	100%	100%
4-Speed Automatic	93%	96%	81%	71%
5-Speed Manual	7%	4%	NA	0%
5-Speed HD Manual	NA	NA	19%	29%
TOTAL	100%	100%	100%	100%
4300 V6	5%	NA	NA	NA
5000 V8	41%	15%	0%	NA
5700 V8	52%	75%	70%	8%
6.5L Turbo-Diesel	2%	10%	30%	6%
7400 V8	NA	0%	0%	86%
TOTAL	100%	100%	100%	100%

Crew-Cab 100%

C/K3500	100%
TOTAL MODELS	100%

	C/K 3500
2WD	60%
4WD	40%
TOTAL	100%
Sportside Box	NA
Fleetside Box	100%
TOTAL	100%
Work Truck	NA
Cheyenne	20%
Silverado	80%
TOTAL	100%
4-Speed Automatic	80%
5-Speed Manual	NA
5-Speed HD Manual	20%
TOTAL	100%
4300 V6	NA
5000 V8	NA
5700 V8	10%
6.5L Turbo-Diesel	65%
7400 V8	25%
TOTAL	100%

*Engine split is for non-W T models.

C/K Pickup and Crew-Cab



1997 NEW PRODUCT HIGHLIGHTS

CK1500 PICKUP

AIR BAG FOR FRONT PASSENGER

SPEED SENSITIVE POWER STEERING

DEALERS WILL BE REQUIRED TO ORDER OPTION YG6 (AIR CONDITIONING NOT DESIRED) IF AIR CONDITIONING IS NOT ORDERED OR IS NOT STANDARD.

THREE NEW COLORS. GREEN BLUE METALLIC, ROYAL BLUE METALLIC AND DARK CARMINE RED METALLIC.



•
•



1500 PICKUP EQUIPMENT SUMMARY

STANDARD INTERIOR FEATURES

		X81	CHEYENNE	SILVERADO
AIR BAGS:	DRIVER'S SIDE & <u>PASSENGER</u> (FRONT)	S	S	S
CUPHOLDERS:	DUAL IN DASH	S	S	S
DOOR BEAMS:	SIDE IMPACT	S	S	S
GAGES:	TRIP ODOMETER, OIL PRESSURE, VOLTMETER AND TACHOMETER	S	S	S
GLASS:	SOLAR RAY TINTED, ALL WINDOWS	S	S	S
JACK:	WITH WHEEL WRENCH	S	S	S
INSULATION:	UNDER DASH & FLOOR COVERING	S	S	S
LIGHTING:	DOME W/LH & RH DOOR SWITCH W/DELAYED ENTRY FEATURE, READING, ASHTRAY, GLOVE-BOX, UNDERHOOD & CARGO LAMPS	S	S	S
POWER POINTS:	DUAL COVERED	S	S	S
SCOTCHGARD:	ALL CLOTH AND CARPET SURFACES	S	S	S
SEAT BELTS:	ADJUSTABLE HEIGHT, FRONT	S	S	S
WARNING TONE:	KEY-IN-IGNITION BUZZER	S	S	S

STANDARD EXTERIOR FEATURES

		X81	CHEYENNE	SILVERADO
AIR DAM:	DARK ARGENT	S	S	S
LAMPS:	DAYTIME RUNNING	S	S	S
SPARE TIRE:	FULL SIZE TIRE & WHEEL, W/WINCH TYPE CARRIER MOUNTED UNDER REAR FRAME	S	S	S
TAILGATE:	REMOVABLE	S	S	S
TOW HOOKS:	TWO FRONT ON 4X4 MODELS	S	S	S
WIPERS:	INTERMITTENT WINDSHIELD W/PULSE WASHERS	S	S	S
WIRE HARNESS:	7 LEAD TRAILERING	S	S	S
WINDOW:	REAR QUARTER SWING-OUT (EXT CAB ONLY)	--	S	S

STANDARD CHASSIS FEATURES

		X81	CHEYENNE	SILVERADO
BATTERY:	HEAVY-DUTY 600 CCA	S	S	S
BRAKES:	POWER ASSISTED FRONT DISC, REAR DRUM 4-WHEEL ANTI-LOCK	S	S	S
ENGINE:	VORTEC 4300 V6 SFI (W/O C/K10953)	S	S	S
	VORTEC 5000 V8 SFI (C/K10953)	S	S	S
EXHAUST SYSTEM:	STAINLESS STEEL	S	S	S
FUEL TANK:	25 GAL W/SHORT BOX MODELS	S	S	S
	34 GAL W/LONG BOX MODELS	S	S	S
GENERATOR:	100 AMP	S	S	S
<u>STEERING:</u>	<u>SPEED SENSITIVE POWER (EVO)</u>	S	S	S
STORAGE BOX:	UNDERHOOD, COVERED	S	S	S
SUSPENSION FRNT:	INDEPENDENT COIL W/2WD	S	S	S
	INDEPENDENT TORSION BAR W/4X4	S	S	S
SUSPENSION RR:	MULTI-LEAF SPRINGS	S	S	S
TRANSMISSION:	5-SPEED MANUAL, W/OVERDRIVE	S	S	S

BOLD, ITALICS AND UNDERLINED INDICATES NEW FOR '97

REVISED: 8-19-96

1997 ORDER GUIDE

C/K 1500 PICKUP

Page 1

Prices Shown Are Manufacturer's Suggested Retail Prices (MSRP) At The Time Of Publication. These Prices Are To Be Used Only As An Aid To Inventory Management Since MSRP Figures Change Periodically. The Vehicle Price Schedule Is The Official Pricing Documentation Of Chevrolet Motor Division And Should Be Used In Discussing Vehicle Prices With Potential Buyers. The Model Prices Shown In The Order Guide Include The Destination Freight Charges.

1500 PICKUP TRIM DEFINITION & OPTION SUMMARY

INTERIOR TRIM		X81	CHEYENNE	SILVERADO
AIR CONDITIONING:		--	--	S
ASSIST HANDLES:	PASSENGER	S	S	S
CONVENIENCE GP:	POWER WINDOWS, LOCKS	--	--	S
	TILT WHEEL AND CRUISE CONTROL	--	--	S
DOOR TRIM:	MOLDED PLASTIC W/ARMREST	S	S	--
	COLOR-KEYED CLOTH AND CARPET TRIMMED	--	--	S
FLOOR COVERING:	FULL BLACK RUBBER	S	--	--
	COLOR-KEYED CARPET	--	--	S
	COLOR-KEYED RUBBER	--	S	--
	RUBBER FLOOR MATS	--	--	S
HEADLINER:	VINYL	S	--	--
	COLOR-KEYED CLOTH	--	S	S
INSULATION:	ADDITIONAL SOUND-DEADENING	--	--	S
MAP POCKETS:	IN PASSENGER AND DRIVER'S DOOR	S	S	S
RADIO:	AM/FM STEREO W/SEEK-SCAN AND CLOCK	S	S	--
	AM/FM STEREO W/SEEK-SCAN, CLOCK AND CASSETTE TAPE	--	--	S
SEATING:	CLOTH BENCH	--	--	S
	VINYL BENCH (N/A EXT CAB)	S	S	--
	CLOTH 60/40 SPLIT BENCH (EXT CAB)	--	--	S
	VINYL 60/40 SPLIT BENCH (EXT CAB)	--	S	--
STEERING WHEEL:	SIMULATED LEATHER	S	S	--
	LEATHER WRAPPED	--	--	S
STORAGE TRAY:	FULL WIDTH BEHIND SEAT	--	--	S
SUNSHADES:	CLOTH COVERED W/LH STORAGE STRAP W/RH MIRROR	S	S	S

EXTERIOR TRIM		X81	CHEYENNE	SILVERADO
BUMPER FRT:	CHROME	S	S	--
	CHROME W/BLACK RUB STRIP	--	--	S
BUMPER RR:	CHROME W/STEP PAD	--	--	S
GRILLE:	MOLDED, PAINTED ARGENT	S	S	--
	CHROME DELUXE	--	--	S
HEADLAMPS:	SINGLE RECTANGULAR HALOGEN	S	S	--
	DUAL COMPOSITE - HALOGEN	--	--	S
HORN:	SINGLE NOTE	S	S	--
	DUAL NOTE	--	--	S
MIRRORS:	BREAK-A-WAY OSRV, BLACK	S	S	--
	ELECTRIC, REMOTE CONTROL, BLACK	--	--	S
MOLDINGS:	BODY SIDE WITH BRIGHT TRIM AND BRIGHT WHEEL OPENING TRIM	--	--	S
NAMEPLATES:	W/T DECAL ON TAILGATE	S	--	--
	CHEYENNE BADGE ON B-PILLAR	--	S	--
	SILVERADO BADGE ON B-PILLAR	--	--	S
PAINT:	SINGLE TONE	S	S	S
WHEELS:	SILVER PAINTED W/BLACK CENTER CAP	S	S	--
	RALLY WHEEL TRIM	--	--	S

BOLD, ITALICS AND UNDERLINED INDICATES NEW FOR '97

C/K 1500 PICKUP

1997 ORDER GUIDE

REVISED: 8-19-96

Page 2

Prices Shown Are Manufacturer's Suggested Retail Prices (MSRP) At The Time Of Publication. These Prices Are To Be Used Only As An Aid To Inventory Management Since MSRP Figures Change Periodically. The Vehicle Price Schedule Is The Official Pricing Documentation Of Chevrolet Motor Division And Should Be Used In Discussing Vehicle Prices With Potential Buyers. The Model Prices Shown In The Order Guide Include The Destination Freight Charges.

MODEL AND BODY

Description	Model No	Body	Wheel Base
2-WHEEL-DRIVE MODELS			
Sportside	CC10703	E62	117.5
Fleetside	CC10703	E63	117.5
Fleetside	CC10703	E63 & X81	117.5
Fleetside	CC10903	E63	131.5
Fleetside	CC10903	E63 & X81	131.5
Sportside, Ext Cab	CC10753	E62	141.5
Fleetside, Ext Cab	CC10753	E63	141.5
Fleetside, Ext Cab	CC10953	E63	155.5

Description	Model No	Body	Wheel Base
4-WHEEL-DRIVE MODELS			
Sportside	CK10703	E62	117.5
Fleetside	CK10703	E63	117.5
Fleetside	CK10703	E63 & X81	117.5
Fleetside	CK10903	E63	131.5
Fleetside	CK10903	E63 & X81	131.5
Sportside, Ext Cab	CK10753	E62	141.5
Fleetside, Ext Cab	CK10753	E63	141.5
Fleetside, Ext Cab	CK10953	E63	155.5

*Includes Destination & Handling Charges

EMISSIONS (Must Specify One) (Refer Emission Requirements Section)

- FE9 Federal Emission Requirements
- YF5 California Emission Requirements
- NG1 New York/Massachusetts Emission Requirements
- NB8 California or New York/Massachusetts Emission Override (Reqs FE9 Federal Emissions)
- NC7 Federal Emission Override (Reqs YF5 California or NG1 New York/Massachusetts Emissions)

***GVWR SELECTOR (Must Specify GVW Option)**

Minimum Equipment Required for GVW Rating				
GVW Option	GVW Rating	GAWR*		
Required (lbs)		Front	Rear	
C10703-C10903				
C5M	6100	3150	3686	X81 Reqs L35 Eng
K10703-K10903				
C5M	6100	3600	3750	X81 Reqs L35 Eng
C10753-C10953				
Q4B	6200	3500	3686	None
K10753-K10953				
Q4B	6200	3600	3750	N/A F44 Chassis or L56 Eng
C5S	6600	3600	3750	Reqs F44 (N/A L56 Eng w/K10953)
C5U	6800	3600	3750	Reqs L56 Eng (N/A K10753)

*GAWR's shown are the minimum for each axle with equipment listed. Other GAWR's are available, and they are determined as the minimum capacity of either axle, springs or tires.

POWER TEAMS (Must Specify Engine, Transmission and Rear Axle)

(Consult GVWR Selector For Minimum Equipment Required)

ENGINE	TRANSMISSION		AXLES			GVWR
	5-SP Manual Lt Duty / H Duty	4-Speed AUTO Lt Duty	3.08	3.42	3.73	
CC10703						
L35 Vortec 4300 V6 (262 Cu In)--SFI	MG5	M30	GU4	GU6		6100
L30 Vortec 5000 V8 (305 Cu In)--SFI	MG5	M30	(a) GU4	(a) GU6	--	6100
L31 Vortec 5700 V8 (350 Cu In)--SFI	M50	M30	GU4	GU6	GT4	6100
CK10703						
L35 Vortec 4300 V6 (262 Cu In)--SFI	MG5	M30	--	--	GT4	6100
L30 Vortec 5000 V8 (305 Cu In)--SFI	MG5	M30	--	(a) GU6	(a) GT4	6100
L31 Vortec 5700 V8 (350 Cu In)--SFI	M50	M30	--	GU6	GT4	6100

(a) N/A YF5 California Emissions

POWER TEAMS (Must Specify Engine, Transmission and Rear Axle)

(Consult GVWR Selector For Minimum Equipment Required)

ENGINE	TRANSMISSION		AXLES			GVWR
	5-SP Manual Lt Duty / H Duty	4-Speed AUTO Lt Duty / H Duty	3.08	3.42	3.73	
CC10903						
L35 Vortec 4300 V6 (262 Cu In)--SFI	MG5	M30	GU4	GU6	--	6100
L30 Vortec 5000 V8 (305 Cu In)--SFI	MG5	M30	(a) GU4	(a) GU6	--	6100
L31 Vortec 5700 V8 (350 Cu In)--SFI	M50	M30	GU4	GU6	GT4	6100
CK10903						
L35 Vortec 4300 V6 (262 Cu In)--SFI	MG5	M30	--	--	GT4	6100
L30 Vortec 5000 V8 (305 Cu In)--SFI	MG5	M30	--	(a) GU6	(a) GT4	6100
L31 Vortec 5700 V8 (350 Cu In)--SFI	M50	M30	--	GU6	GT4	6100

(a) N/A YF5 California Emissions

CONTINUED ON PAGE 5

POWER TEAMS (Continued)

(Consult GVWR Selector For Minimum Equipment Required)

ENGINE	TRANSMISSION		AXLES			GVWR
	5-SP Manual Lt Duty	4-Speed AUTO Lt Duty / H Duty	3.08	3.42	3.73	
CC10753						
L35 Vortec 4300 V6 (262 Cu In)--SFI	MG5	M30	--	GU6	--	6200
L30 Vortec 5000 V8 (305 Cu In)--SFI	MG5	M30	(a) GU4	(a) GU6	--	6200
L31 Vortec 5700 V8 (350 Cu In)--SFI	M50	M30	GU4	GU6	GT4	6200
L31 Vortec 5700 V8 (350 Cu In)--SFI	M50	M30	GU4	GU6	GT4	6200
CK10753						
L35 Vortec 4300 V6 (262 Cu In)--SFI	MG5	M30	--	--	(a) GT4	6200/6600
L30 Vortec 5000 V8 (305 Cu In)--SFI	MG5	M30	--	(a) GU6	(a) GT4	6200/6600
L31 Vortec 5700 V8 (350 Cu In)--SFI	M50	M30	--	GU6	GT4	6200/6600
L56 Turbo Diesel V8 6.5 Liter (400 Cu In)		MT1	--	(a) GU6	(a) GT4	6600

(a) N/A YF5 California Emissions

POWER TEAMS (Must Specify Engine, Transmission and Rear Axle)

(Consult GVWR Selector For Minimum Equipment Required)

ENGINE	TRANSMISSION		AXLES			GVWR
	5-SP Manual Lt Duty / H Duty	4-Speed AUTO Lt Duty / H Duty	3.08	3.42	3.73	
CC10953						
L30 Vortec 5000 V8 (305 Cu In)--SFI	MG5	M30	(a) GU4	(a) GU6	--	6200
L31 Vortec 5700 V8 (350 Cu In)--SFI	M50	M30	GU4	GU6	GT4	6200
L31 Vortec 5700 V8 (350 Cu In)--SFI	M50	M30	GU4	GU6	GT4	6200
CK10953						
L30 Vortec 5000 V8 (305 Cu In)--SFI	MG5	M30	--	(a) GU6	(a) GT4	6200/6600
L31 Vortec 5700 V8 (350 Cu In)--SFI	M50	M30	--	GU6	GT4	6200
L31 Vortec 5700 V8 (350 Cu In)--SFI	M50	M30	--	(a) GU6	GT4	6600
L56 Turbo Diesel V8 6.5 Liter (400 Cu In)		MT1	--	(a) GU6	(a) GT4	6800

(a) N/A YF5 California Emissions

CAPACITIES

C10703--C10903		K10703		K10903	
SPRINGS:		SPRINGS:		SPRINGS:	
Front		Front		Front	
	3200		3600		3600
Rear		Rear		Rear	
	3750		3750		3750
AXLES:		AXLES:		AXLES:	
Front		Front		Front	
	3150		3925		3925
Rear		Rear		Rear	
	3750		3750		3750

C10753--C10953		K10753-K10953	
SPRINGS:		SPRINGS:	
Front		Front	
	3500		3600
	3600		
Rear		Rear	
	3750		3750
AXLES:		AXLES:	
Front		Front	
	3600		3925
Rear		Rear	
	3750		3750

TIRES: (Must Specify Front and Rear) (Spare Tire Included)

Description	All Season		All Terrain		On-Off Road	
	Front	Rear	Front	Rear	Front	Rear
C10703-C10903						
TUBELESS Steel Belted Radial						
P235/75R15 B/W	XFL	YFL				
(a)P235/75R15 W/L	XFN	YFN				
K10703-K10903						
TUBELESS Steel Belted Radial						
P245/75R16 B/W			XGA	YGA		
P245/75R16 WOL			XGB	YGB		
LT245/75R16-C B/W					XBN	YBN
LT245/75R16-C WOL					XBX	YBX
(b)P265/75R16 B/W					XGC	YGC
(b)P265/75R16 WOL					XGD	YGD
C10753-C10953						
TUBELESS Steel Belted Radial						
P235/75R15 B/W	XFL	YFL				
P235/75R15 W/L	XFN	YFN				
K10753-K10953						
TUBELESS Steel Belted Radial						
P245/75R16 B/W			XGA	YGA		
P245/75R16 WOL			XGB	YGB		
LT245/75R16-C B/W					XBN	YBN
LT245/75R16-C WOL					XBX	YBX
(b)P265/75R16 B/W					XGC	YGC
(b)P265/75R16 WOL					XGD	YGD

(a) N/A X81 Work Pkg
 (b) Reqs PF4 Wheels; w/o L31 Eng Reqs GT4 Axle; N/A X81 Work Pkg

B/W = Blackwall
 W/L = White Lettered
 WOL = White Outlined Letter

MUST SPECIFY:

AXLE, EMISSION, ENGINE, TIRES AND TRANSMISSION

**No Deletions Allowed. Additional Options/Upgrades (Where Indicated)
May be Ordered from the Custom Ordering Option Listing.**

REG & EXT CAB DECOR

	* X81	CHEYENNE		SILVERADO	
		1 S W	1 S A	1 S B	1 S C
WORK TRUCK DECOR	X81	x	--	--	--
Fleetside Body Code without BYP Sport Package (A)	E63	x	x	x	x
CHEYENNE DECOR			x	--	--
SILVERADO DECOR				x	x
SILVERADO DECOR (Leather)					
Regular Cab					
Extended Cab					
Keyless Entry	AU0				x
Mirror, Electrochromic ISRV w/8 Point Compass	DD7				x
Seat, Power (B)	AG9				x
Trim, Leather (C)	AE7				x

- * 1SW PEG N/A Extended Cab
- (A) May Substitute E62 Sportside on Cheyenne or Silverado Decor w/o X81 Work Truck
- (B) Extended Cab Only
- (C) Must Specify Trim Color. May Upgrade to A95 Seat on Extended Cab

Preferred Equipment Group Prices

- N.C. 1SW
PEG Savings
**(-500.00) w/MG5
- N.C. 1SA
PEG Savings
**(-1,200.00) w/MG5 or M50 & R9A & R9B
**(-1,000.00) w/MG5 or M50 & R9A
**(-700.00) w/MG5 or M50 & R9B
**(-700.00) w/M30 or MT1 & R9A & R9B
**(-500.00) w/MG5 or M50
**(-500.00) w/M30 or MT1 & R9A
**(-200.00) w/M30 or MT1 & R9B
N.C. w/M30 or MT1

Preferred Equipment Group Price

- N.C. 1SB or 1SC
PEG Savings
**(-1,250.00) w/MG5 or M50
**(-750.00) w/M30 or MT1

**PEG Savings Amount represents the savings for Preferred Equipment Groups.

REGULAR CAB MARKETING PACKAGES

CONVENIENCE PACKAGE

ORDERING OPTION=R9A
(Reqs Peg 1SA)

Incls :

- C60 Air Conditioning
- ZQ3 Tilt and Cruise
- UM6 Radio w/Cassette

BRIGHT APPEARANCE PACKAGE

w/E62

w/E63

ORDERING OPTION=R9B

(Reqs Peg 1SA)

Incls :

- B85 Body Side Molding
- V22 Chrome Grille
- VB3 Chrome Rear Step Bumper
- VG3 Chromed Front Bumper
- P06 Rally Wheels (Upgrade Allowed)

SPORT PACKAGE

w/2-Wheel Drive

w/4-Wheel Drive

ORDERING OPTION=BYP

(Reqs C-K10703 And Peg 1SB/1SC)

(Refer Page 19 For Color/ Trim Availability)

Incls :

- Body Color Front and Rear Painted Bumpers
- Fog Lamps and Sport Identification Decals
- Non-Electric Color-Keyed Mirror
- N90/PF4 Aluminum Wheels
(N83 Chrome Wheels may be substituted)
- BYP Sport Pkg
- E62 Sportside Body
- XFL, YFL on C10703
- XGC, YGC on K10703
- N/A VYU Snow Plow or F60 Springs

EXTENDED CAB MARKETING PACKAGES

CONVENIENCE PACKAGE

ORDERING OPTION=R9A

(Reqs Peg 1SA)

Incls :

- C60 Air Conditioning
- ZQ3 Tilt and Cruise
- UM6 Radio w/Cassette

BRIGHT APPEARANCE PACKAGE

w/E62

w/E63

ORDERING OPTION=R9B

(Reqs Peg 1SA)

Incls :

- B85 Body Side Moldings
- V22 Chrome Grille
- VB3 Chrome Rear Step Bumper
- VG3 Chromed Front Bumper
- P06 Rally Wheels (Upgrade Allowed)

ADDITIONAL OPTIONS

OPTION

- ACKNOWLEDGEMENTS:**
 R8S Multiple Order Numbers
 R8T Preliminary Invoice (Refer Vehicle Price Schedule for Prices)
 K47 **AIR CLEANER:** High Capacity
AIR CONDITIONING: (One Of The Following Must Be Specified)
 YG6 Air Conditioning Not Desired
 C60 Air Conditioning: (Incls R134A Refrigerant)
AXLES, REAR: (Refer Power Teams Chart for Availability)
 GU4 3.08 Ratio
 GU6 3.42 Ratio
 GT4 3.73 Ratio
 G80 Locking Differential (N/A GU4 Axle)
BEDLINER: Under Rail
BODY CODE: 8 Ft. Fleetside
BUMPER EQUIPMENT: Painted, Rear Step (Vehicles registered in certain states must have a rear bumper to be operated on their roads. Consult your local laws.) (Work Truck does not include a Rear Bumper)
 V10 **COLD-CLIMATE PACKAGE:** (Incls Eng Block Heater)
 ZQ3 **CONVENIENCE PACKAGE:** Cruise and Tilt
 KC4 **COOLER:** Engine Oil (N/A GT4 Axle) (Engine Oil Cooler comparable to KC4 is standard w/GT4 Axle)
 w/Z82
 w/o Z82
EMISSIONS: (Refer Emission Requirements Tab Section)
 FE9 Federal Emission Requirements
 YF5 California Emission Requirements
 NG1 New York/Massachusetts Emission Requirements
 NB8 California Emission or New York/Massachusetts Override (Reqs FE9 Federal Emissions)
 NC7 Federal Emission Override (Reqs YF5 California or NG1 New York/Massachusetts Emissions)
 L35 **ENGINE:** Vortec 4300 V6 (262 Cu In)-SFI (Refer Power Teams Chart for Availability)
 C5M **GVWR:** 6100# (Must Specify) (Refer GVWR Selector Chart for Availability)
 VK3 **LICENSE PLATE BRACKET:** Front
 ZY1 **PAINT, EXTERIOR:** Solid (Refer Color/Trim Chart for Availability)
RADIO EQUIPMENT:
 UM6 Electronically Tuned AM/FM Stereo Radio w/Seek-Scan, Stereo Cassette Tape and Digital Clock
 UL5 Radio Delete
 A52 **SEAT:** Bench Seat
SHOCK ABSORBERS:
 FG5 Front and Rear, Gas, 46MM, Bilstein (N/A K1500)
 F51 Front and Rear, Heavy Duty (Incl w/VYU Snow Plow Pkg)
 w/VYU or Z82
 w/o VYU or Z82
 NZZ **SKID PLATE:** Off-Road (K1500 Only) (Incls Engine Front Differential and Transfer Case Shield)
 VYU **SNOW PLOW PREP PACKAGE:** (K10903 Only) (Incls F60 Front Springs and F51 HD Shock Absorbers)
 F60 **SPRINGS, FRONT:** Heavy Duty (K10903 Only) (Incl w/VYU Snow Plow)
 w/VYU
 w/o VYU
TIRES: (Refer to Tire Chart for Availability and vehicle Price Schedule for Prices)
 V76 **TOW HOOKS:** Two Front (Std on K1500)
 Z82 **TRAILERING SPECIAL EQUIPMENT:** Heavy-Duty (Incls Trailer Hitch, F51 Shocks and KC4 Eng Oil Cooler) (Reqs M30 Transmission, KC-K10903 Reqs V43 Bumper) (N/A GU4 Axle)
 With GT4 Axle
 w/VYU
 w/o VYU
 Without GT4
 w/VYU
 w/o VYU
TRANSMISSION: (Refer Power Teams Chart for Availability)
 MG5 5-Speed Manual w/Overdrive, Light Duty
 M30 4-Speed Electronic Controlled Automatic with Overdrive
TRIM CODE: (Refer Color/Trim Chart for Availability)
WHEEL TRIM:
 P06 Rally Wheel Trim
 N83 Chrome Wheel (C1500 Only)
 A28 **WINDOWS:** Sliding Rear

C/K 1500 PICKUP CHEYENNE/SILVERADO

ADDITIONAL OPTIONS

INCL W/DECOR		OPTION	DESCRIPTION
CHEY- ENNE	SILVER- ADO		
		R8S	ACKNOWLEDGEMENTS: Multiple Order Numbers
		RBT	Preliminary Invoice (Refer Vehicle Price Schedule for Prices)
		K47	AIR CLEANER: High Capacity (N/A L56 Eng)
			AIR CONDITIONING: (One Of The Following Options Must Be Ordered w/PEG 1SA w/o Convenience Pkg R9A)
		YG6	Air Conditioning Not Desired
	x	C60	Air Conditioning: (Incls R134A Refrigerant w/1SB, 1SC or R9A w/1SA)
	x	V22	APPEARANCE PACKAGE: (Incls Chrome Grills, Composite Halogen Headlamps and Dual Horns) w/1SB, 1SC or R9B w/1SA
			AXLES, REAR: (Refer Power Teams Chart for Availability)
		GU4	3.08 Ratio
		GU6	3.42 Ratio
		GT4	3.73 Ratio w/L35 w/o L35
		G80	Locking Differential (N/A GU4 Axle)
		TP2	BATTERY: Auxiliary (Reqs L30 or L31 Eng) (N/A w/BYP Pkg) (Deletes Underhood Storage Box)
		BZY	BEDLINER: Under Rail (Reqs E63 Body)
			BODY CODE:
		E62	Sportside Body
		E63	Fleetside Body
			BUMPER EQUIPMENT: (Vehicles registered in certain states must have a rear bumper to be operated on their roads. Consult your local laws.) (Cheyenne Decor does not include a Rear Bumper)
		EF1	Bumper Delete Provisions: (N/A Z82 Trailering or BYP Sport Pkg)
N/A	x	VB3	Bumper, Chromed. Rear Step w/Rub Strip (Reqs VG3 Bumper or Silverado Decor) (N/A BYP Pkg) w/1SB, 1SC or R9B w/1SA w/o R9B
	x	VG3	Bumper, Chromed. Front Deluxe w/Rub Strip (N/A BYP Pkg) w/1SB, 1SC or R9B w/1SA w/o R9B
	N/A	V43	Bumper, Painted. Rear Step (Reqs E63 Body) w/BYP w/o BYP
			CHASSIS EQUIPMENT:
		F44	Heavy-Duty (K1500 Extended only) (Reqs C55 #6600 GVW) (Incl w/L56 Eng) w/Diesel Eng w/o Diesel Eng
N/A		Z71	Off-Road Package (K1500 Only) (Reqs XGC, XGD, XBN or XBX Tires) (Incls NZZ Skid Plate) (N/A F51 Shocks)
	x	VD	COLD-CLIMATE PACKAGE: (Incls Eng Block Heater) (Diesel Eng Reqs Base Decor and Regular Cab)
		ZQ3	CONVENIENCE GROUP: Tilt Wheel and Speed Control w/1SB, 1SC or R9A w/1SA w/o R9A
		KC4	COOLING SYSTEM: (Engine Oil Cooler comparable to KC4 is standard w/GT4 Axle and/or Diesel Eng) w/1SA w/o R9A
			COOLING SYSTEM: (Engine Oil (K107*3/K10903 Reqs L30 or L31 Eng) (N/A Diesel Eng or GT4 Axle)
		KNP	Transmission, Heavy-Duty, Auxiliary (Reqs Auto Trans) (N/A L35 or L30 Eng) (L31 Eng and M30 Trans w/o GU4 Axle) (Incl w/Z82 Trailering when L31 Eng w/o GU4 or L56 Eng, w/Permanent Trans as specified Also, included w/MT1 Trans)
N/A		C49	DEFOGGER: Rear Window Electric (N/A A28 Window) (N/A C-K10*03)
N/A		E24	THIRD DOOR: (Reqs C*10713, L30 or L31 Eng and M30 Trans) (N/A BGS Floor Console, Vinyl Trim or ZY4 Paint) (Door Lock Latch is Non-Electric)
			EMISSIONS: (Refer Emission Requirement Tab Section)
		FE9	Federal Emission Requirements
		YF5	California Emission Requirements
		NG1	New York/Massachusetts Emission Requirements
		NB8	California or New York/Massachusetts Emission Override (Reqs FE9 Federal Emissions)
		NC7	Federal Emission Override (Reqs YF5 California or NG1 New York/Massachusetts Emissions)
			ENGINES: (Refer Power Teams Chart for Availability)
		L35	Vortec 4300 V6 (262 Cu In) - SFI
		L30	Vortec 5000 V8 (305 Cu In) - SFI w/CK10953 w/o CK10953

C/K 1500 PICKUP CHEYENNE/SILVERADO

ADDITIONAL OPTIONS

INCL W/DECOR		OPTION	
CHEY- ENNE	SILVER- ADO		
		L31	ENGINES: (Continued) Vortec 5700 V8 (350 Cu In)-SFI w/CK10953 w/oCK10953
		L56	6.5 Liter V8 Turbo Diesel (400 Cu In) (Deletes Underhood Storage Box) w/CK10953 w/oCK10953
N/A		BG9	FLOOR COVERING: Full Floor, Rubber, Color-Keyed (Replaces Carpeting and Floor Mats) (N/A BYP Sport Pkg) w/CK10*03 w/CK10*53
	N/A	B30	Carpet Floor Covering w/CK10*03 w/CK10*53
	N/A	B32	Floor Mats (Reqs B30 Floor Covering)
	N/A	B33	Floor Mats (N/A YG4 Seat Delete) (Reqs B30 Carpet, B32 Floor Mats and C-K***53)
		AJ1	GLASS: Deep Tinted Solar-Ray (C-K10*03 Reqs A28 Sliding Rear Window) (When C49 Defogger is Specified, Rear Window is Light Tint Glass) C10*03w/A28 w/C49 w/oC49
			GVWR: (Must Specify One) (Refer GVWR Selector Chart for Availability)
		C5M	6100#
		Q4B	6200#
		C5S	6600#
		C5U	6800#
N/A		AJ0	KEYLESS ENTRY: Remote w/1SC w/o1SC
		VK3	LICENSE PLATE BRACKET: Front
	x	AU3	LOCKS: Power door
			MIRRORS:
		DF2	Camper Type, Stainless Steel 7.5" W x 10.5" H, Exterior (N/A BYP Sport Pkg) w/1SB or 1SC w/1SA
N/A		DD7	10" Electrochromic ISRV with 8 Point Compass, Interior w/1SC w/1SB
	x	B85	MOLDING: Exterior, Bright (Incls Bright Wheel Opening w/E63 Fleetside) (N/A BYP PKG) w/1SB or 1SC or R9B w/E62 and 1SA w/o R9B w/E63 and 1SA w/o R9B
			PAINT, EXTERIOR: (Refer Color/Trim Chart for Availability)
		ZY1	Solid
N/A		ZY2	Conventional Two-Tone
N/A		ZY4	Deluxe Two-Tone (N/A E62 Body)
			RADIO EQUIPMENT:
	x	UM6	Electronically Tuned AM/FM Stereo Radio w/Seek-Scan, Digital Clock and Cassette Tape w/1SB, 1SC or R9A w/1SA
N/A		UL0	Electronically Tuned AM/FM Stereo Radio w/Seek-Scan, Digital Clock, Automatic Tone Control, Cassette Tape, Theft Lock and Speed Compensated Volume (Incls an Enhanced Performance Speaker System)
N/A		UN0	Electronically Tuned AM/FM Stereo Radio w/Seek-Scan, Digital Clock, Automatic Tone Control, Compact Disc Player, Theft Lock and Speed Compensated Volume (w/Silverado Decor Incls an Enhanced Performance Speaker System)
N/A		UP0	Electronically Tuned AM/FM Stereo Radio w/Seek-Scan, Digital Clock, Automatic Tone Control, Stereo Cassette Tape w/Search and Repeat, Compact Disc Player, Theft Lock and Speed Compensated Volume (w/Silverado Decor Incls an Enhanced Performance Speaker System) (Reqs M30 or MT1 Trans)
	N/A	UL5	Radio Delete
N/A		AG9	SEAT: Power Driver's Seat (N/A Vinyl Trim or A52 Bench Seat) (N/A C-K 10*03) w/1SC w/o1SC
	N/A	YG4	SEAT DELETE: Rear (N/A C-K10*03)
			SEAT TYPE: (Refer Color/Trim Chart for Availability)
		A52	Bench Seat (Incls Storage Armrest and Power Lumbar w/Custom Cloth or Leather Trim) w/oLeather w/Leather

REVISED: 8-19-96

1997 ORDER GUIDE

C/K 1500 PICKUP

Page 11
Prices Shown Are Manufacturer's Suggested Retail Prices (MSRP) At The Time Of Publication. These Prices Are To Be Used Only As An Aid To Inventory Management Since MSRP Figures Change Periodically. The Vehicle Price Schedule Is The Official Pricing Documentation Of Chevrolet Motor Division And Should Be Used In Discussing Vehicle Prices With Potential Buyers. The Model Prices Shown In The Order Guide Include The Destination Freight Charges.

C/K 1500 PICKUP CHEYENNE/SILVERADO ADDITIONAL OPTIONS

INCL W/DECOR		OPTION
CHEY- ENNE	SILVER- ADO	
		SEAT TYPE: (Continued)
		AE7 Reclining 60/40 Split Bench Seat (Incls Storage Armrest and Power Lumbar w/Custom Cloth or Leather Trim) w/1SC Extended Cab w/1SA or 1SB w/o Leather w/1SB and Leather Regular Cab w/1SA or 1SB w/o Leather w/1SB and Leather
		A95 Reclining High Back Bucket Seats (Incls Power Lumbar and Floor Console; Also Includes Overhead Console on Extended Cab) Extended Cab w/1SC w/1SB and Cloth w/1SB and Leather Regular Cab w/1SB and Cloth w/1SB and Leather
		SHOCK ABSORBERS:
		FG5 Front and Rear, Gas, 46MM, Bilstein (N/A 4-Wheel Drive) (N/A Z82 Trailering on Ext Cab Models)
		F51 Front and Rear, Heavy Duty (N/A Z71 Off-Road Chassis) (Incl w/Z82 Trailering or VYU Snow Plow Pkg) w/Z82 or VYU w/o Z82 or VYU
		NZZ SKID PLATE: Off-Road (K1500 Only) (Incls Front Differential and Transfer Case Shield) (Incl w/Z71 Off-Road Chassis) w/Z71 w/o Z71
		VYU SNOW PLOW PREP PACKAGE: (K1500 Only) (N/A Diesel Eng) (GU6 Axle w/o Z82 Trailering Reqs KC4 Eng Oil Cooler) (N/A CK10*53) (w/o Z71 Off-Road Package Incls F60 Front Springs and F51 Shock Absorbers) (GU6 Axle N/A w/Z71 On/Off Road Pkg) w/Z71 w/o Z71
		F60 SPRINGS: Front, Heavy Duty (K1500 Only) (N/A Diesel Eng or Z71 Off-Road Chassis) (Incl w/VYU Snow Plow Pkg) w/VYU w/o VYU
		TIRES: Tubeless, Steel Belted Radial (Refer Tire Chart for Availability; Vehicle Price Schedule for Prices)
		V76 TOW HOOKS: Two Front (Standard on K1500 Models) (N/A BYP Pkg on C1500 Model)
		Z82 TRAILERING SPECIAL EQUIPMENT: Heavy-Duty (Incls Trailer Hitch Platform) (w/o Z71 or FG5 Incls F51 Shock Absorbers) (Incls KC4 Eng Oil Cooler w/o GT4 Axle or Diesel Eng) (C-K10903 or C-K10953 Reqs VB3 or V43 Bumper) (C10* *3 w/L35 Eng Reqs GU6 Axle) (Reqs Automatic Trans) (K10* *3 w/Z71 Off Road Pkg and L30 Eng Reqs GT4 Axle) (N/A Extended Cab w/FG5) With Diesel Engine or GT4 Axle w/Z71 or VYU w/o Z71 or VYU Without Diesel Engine or GT4 Axle w/VYU or Z71 w/o VYU or Z71
		NP1 TRANSFER CASE: Electronic Shift Control, 2-Speed (Reqs 4-Wheel Drive and Automatic Transmission) (Reqs ZQ3 Convenience Pkg or Silverado Decor) (K10*53 Reqs MT1 Trans)
		TRANSMISSIONS: (Refer Power Teams Chart for Availability)
		MG5 5-Speed Manual with Overdrive, Light Duty
		M50 5-Speed Manual with Overdrive, Light Duty
		M30 4-Speed Electronically Controlled Automatic with Overdrive
		MT1 4-Speed Electronically Controlled Automatic with Overdrive, Heavy-Duty
	x	PO6 WHEEL TRIM: Rally Wheel Trim w/1SB, 1SC or R9B w/1SA
		WHEELS: (Spare is Base Steel)
		N90 Aluminum (C1500 Only) w/BYP w/1SB, 1SC or w/R9B w/1SA and w/o R9B
		PF4 Aluminum (K1500 Only) w/BYP w/1SB, 1SC or R9B w/1SA and w/o R9B
		N83 Chrome Wheel (C1500 Only) w/BYP w/1SB, 1SC or R9B w/1SA and w/o R9B
		A28 WINDOWS: Sliding Rear (N/A C49 Defogger)

**C/K 1500 PICKUP
PAINT APPLICATIONS
WITH ZY1, ZY2 AND ZY4 PAINT SCHEMES
(ZY4 N/A w/E62 BODY CODE)**

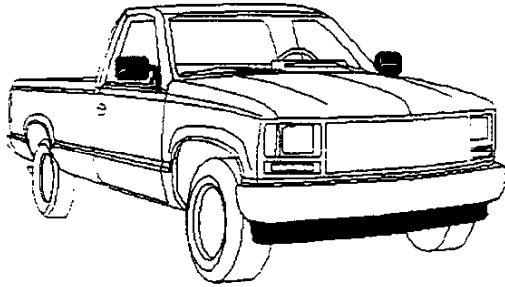

SOLID PAINT - ZY1 (w/E63 Fleetside)

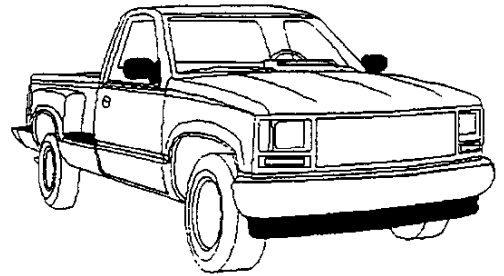

SOLID PAINT - ZY1 (w/E62 Sportside)

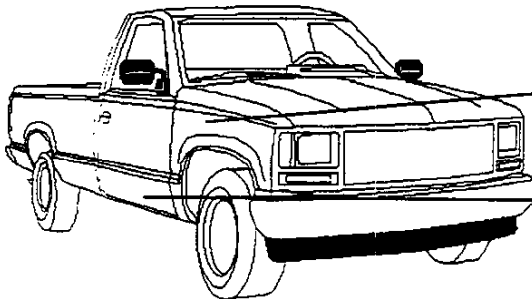

CONVENTIONAL TWO-TONE PAINT-ZY2 (w/E63 Fleetside)

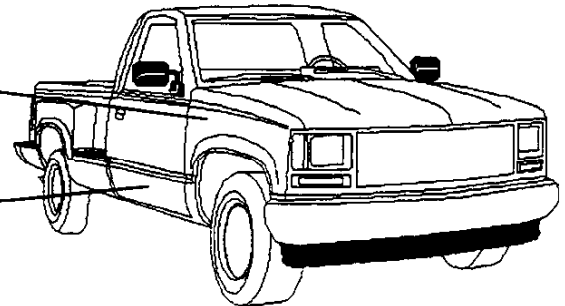

CONVENTIONAL TWO-TONE PAINT-ZY2 (w/E62 Sportside)

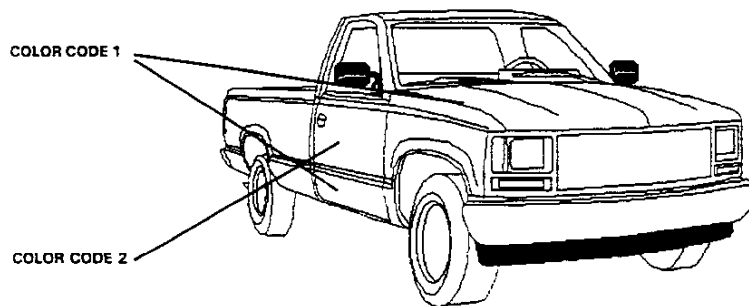

**DELUXE TWO-TONE PAINT - ZY4 (Reqs E63 Fleetside)
(Incls Decal Striping)**

C/K 1500 PICKUPS INTERIOR AND EXTERIOR COLOR AVAILABILITY CHART WITH ZY1 PAINT SCHEMES

PLEASE NOTE: Below are the interior trim color and exterior paint combinations recommended by Chevrolet. They are the only available interior and exterior combinations allowed.

TRIM LEVEL (Must Specify Seat Option and Interior Color) Seat Type	SEAT OPT	INTERIOR COLORS				
		Neutral	Blue	Gray	Red	
CHEYENNE/X81 WORK TRUCK PKG (STD DECOR)						
REGULAR CAB						
Vinyl Bench Seat	A52	52V	26V	13V	79V	
Cloth Bench Seat	A52	52C	26C	13C	79C	
EXTENDED CAB						
Vinyl Reclining Split Bench Seat	AE7	52V	26V	13V	79V	
Cloth Reclining Split Bench Seat	AE7	52C	26C	13C	79C	
SILVERADO DECOR						
REGULAR CAB						
Vinyl Bench Seat	A52	52V	26V	13V	79V	
Custom Cloth Bench Seat	A52	52D	26D	13D	79D	
* Custom Leather Bench Seat	A52	522	262	132	792	
* Custom Cloth Reclining Split Bench Seat	AE7	52D	26D	13D	79D	
* Custom Leather Reclining Split Bench Seat	AE7	522	262	132	792	
Custom Cloth Reclining High Back Bkt Seats	A95	52D	26D	13D	79D	
EXTENDED CAB						
Vinyl Reclining Split Bench Seat	AE7	52V	26V	13V	79V	
Custom Cloth Reclining Split Bench Seat	AE7	52D	26D	13D	79D	
* Custom Leather Reclining Split Bench Seat	AE7	522	262	132	792	
Custom Cloth Reclining High Back Bkt Seats	A95	52D	26D	13D	79D	
* Custom Leather Reclining High Back Bkt Seats	A95	522	262	132	792	
EXTERIOR COLORS	Color Code	PAINT SCHEME	INTERIOR & EXTERIOR COMBINATIONS SHOWN ARE THE ONLY COMBINATIONS AVAILABLE			
^ AUTUMNWOOD, LT (Metallic)	55U	ZY1	x			
BLACK, ONYX	41U	ZY1	x		x	x
^ BLUE, GREEN MED (Metallic)	36U	ZY1	x		x	
BLUE, LT (Metallic)	27U	ZY1		x	x	
BLUE, ROYAL MED (Metallic)	25U	ZY1	x	x	x	
GREEN, EMERALD (Metallic)	43U	ZY1	x		x	
QUICKSILVER (Metallic)	96U	ZY1		x	x	x
RED, CARMINE DK (Metallic)	51U	ZY1	x		x	x
RED, VICTORY	74U	ZY1	x		x	x
WHITE, SUMMIT	50U	ZY1	x	x	x	x

* Leather on Seating Surface Only

C/K 1500 PICKUPS
INTERIOR AND EXTERIOR COLOR AVAILABILITY CHART
ZY2 PAINT SCHEMES
REQUIRES E62/E63 BODY - N/A X81 WORK TRUCK OR BYP SPORT TRUCK

PLEASE NOTE: Below are the interior trim color and exterior paint combinations recommended by Chevrolet. They are the only available interior and exterior combinations allowed.

TRIM LEVEL (Must Specify Seat Option and Interior Color)	SEAT OPT	INTERIOR COLORS					
		Neutral	Blue	Gray	Red		
SILVERADO DECOR							
REGULAR CAB							
Vinyl Bench Seat	A52	52V	26V	13V	79V		
Custom Cloth Bench Seat	A52	52D	26D	13D	79D		
* Custom Leather Bench Seat	A52	522	262	132	792		
Custom Cloth Reclining Split Bench Seat	AE7	52D	26D	13D	79D		
* Custom Leather Reclining Split Bench Seat	AE7	522	262	132	792		
Custom Cloth Reclining High Back Bkt Seats	A95	52D	26D	13D	79D		
EXTENDED CAB							
Vinyl Reclining Split Bench Seat	AE7	52V	26V	13V	79V		
Custom Cloth Reclining Split Bench Seat	AE7	52D	26D	13D	79D		
* Custom Leather Reclining Split Bench Seat	AE7	522	262	132	792		
Custom Cloth Reclining High Back Bkt Seats	A95	52D	26D	13D	79D		
* Custom Leather Reclining High Back Bkt Seats	A95	522	262	132	792		
EXTERIOR COLORS	Color Code 1	Color Code 2	PAINT SCHEME				
Autumnwood, Lt (Met)/Red, Carmine Dk (Met)	55U	51L	ZY2	x			x
Black, Onyx/Autumnwood, Lt (Met)	41U	55L	ZY2	x			
Black, Onyx/Quicksilver (Met)	41U	96L	ZY2			x	x
^ Black, Onyx/Red Victory (Met)	41U	74L	ZY2	x		x	x
^ Blue, Green Med (Met)/Autumnwood, Lt (Met)	35U	55L	ZY2	x			
Blue, Green Med (Met)/Quicksilver (Met)	35U	96L	ZY2			x	
^ Blue, Lt (Met)/Quicksilver (Met)	27U	96L	ZY2		x	x	
Blue, Royal Med (Met)/Autumnwood, Lt (Met)	25U	55L	ZY2	x	x		
Blue, Royal Med (Met)/Quicksilver (Met)	25U	96L	ZY2		x	x	
Green, Emerald (Met)/Autumnwood, Lt (Met)	43U	55L	ZY2	x			
Green, Emerald (Met)/Quicksilver (Met)	43U	96L	ZY2			x	
Quicksilver (Met)/Black, Onyx	96U	41L	ZY2			x	x
^ Quicksilver (Met)/Blue, Lt (Met)	96U	27L	ZY2		x	x	
Quicksilver (Met)/Blue, Royal Med (Met)	96U	25L	ZY2		x	x	
^ Quicksilver (Met)/Green, Emerald (Met)	96U	43L	ZY2			x	
Quicksilver (Met)/Red, Carmine Dk (Met)	96U	51L	ZY2			x	x
Quicksilver (Met)/Red, Victory (Met)	96U	74L	ZY2			x	
Red, Carmine Dk (Met)/Autumnwood, Lt (Met)	51U	55L	ZY2	x			x
Red, Carmine Dk (Met)/Quicksilver (Met)	51U	96L	ZY2			x	x
Red, Victory/Autumnwood, Lt (Met)	74U	55L	ZY2	x			
^ Red, Victory/Black, Onyx	74U	41L	ZY2	x		x	x
Red, Victory/Quicksilver (Met)	74U	96L	ZY2			x	
White, Summit/Autumnwood, Lt (Met)	50U	55L	ZY2	x			
White, Summit/Blue, Lt (Met)	50U	27L	ZY2		x	x	
White, Summit/Blue, Royal Med (Met)	50U	25L	ZY2		x	x	
White, Summit/Red, Carmine Dk (Met)	50U	51L	ZY2				x

* Leather on Seating Surface Only

REVISED: 12-16-96

1997 ORDER GUIDE

C/K 1500 PICKUP

^ Indicates Change

Page 15

Prices Shown Are Manufacturer's Suggested Retail Prices (MSRP) At The Time Of Publication. These Prices Are To Be Used Only As An Aid To Inventory Management Since MSRP Figures Change Periodically. The Vehicle Price Schedule Is The Official Pricing Documentation Of Chevrolet Motor Division And Should Be Used In Discussing Vehicle Prices With Potential Buyers. The Model Prices Shown In The Order Guide Include The Destination Freight Charges.

**C/K 1500 PICKUPS
 INTERIOR AND EXTERIOR COLOR AVAILABILITY CHART
 ZY4 PAINT SCHEMES
 (ZY4 N/A X81 WORK TRUCK OR BYP SPORT TRUCK)
 (REQUIRES E63 BODY)**

PLEASE NOTE: Below are the interior trim color and exterior paint combinations recommended by Chevrolet. They are the only available interior and exterior combinations allowed.

TRIM LEVEL (Must Specify Seat Option and Interior Color)	SEAT OPT	INTERIOR COLOR			
		Neutral	Blue	Gray	Red
Seat Type					
SILVERADO DECOR					
REGULAR CAB					
Vinyl Bench Seat	A52	52V	26V	13V	79V
Custom Cloth Bench Seat	A52	52D	26D	13D	79D
* Custom Leather Bench Seat	A52	522	262	132	792
Custom Cloth Reclining Split Bench Seat	AE7	52D	26D	13D	79D
* Custom Leather Reclining Split Bench Seat	AE7	522	262	132	792
Custom Cloth Reclining High Back Bucket Seats	A95	52D	26D	13D	79D
EXTENDED CAB					
Vinyl Reclining Split Bench Seat	AE7	52V	26V	13V	79V
Custom Cloth Reclining Split Bench Seat	AE7	52D	26D	13D	79D
* Custom Leather Reclining Split Bench Seat	AE7	522	262	132	792
Custom Cloth Reclining High Back Bucket Seats	A95	52D	26D	13D	79D
* Custom Leather Reclining High Back Bucket Seats	A95	522	262	132	792

EXTERIOR COLORS	Color Code 1	Color Code 2	PAINT SCHEME	INTERIOR & EXTERIOR COMBINATIONS SHOWN ARE THE ONLY COMBINATIONS AVAILABLE				STRIPE COLORS Top-Lower/Center
Autumnwood, Lt (Met)/Blue, Green Med (Met)	55U	35L	ZY4	x				Beige/Autumnwood
Autumnwood, Lt (Met)/Green, Emerald (Met)	55U	43L	ZY4	x				Beige/Autumnwood
Autumnwood, Lt (Met)/Red, Carmine Dk (Met)	55U	51L	ZY4	x			x	Beige/Autumnwood
Autumnwood, Lt (Met)/Red, Victory (Met)	55U	74L	ZY4	x				Beige/Black
Black, Onyx/Autumnwood, Lt (Met)	41U	55L	ZY4	x				Beige/Black
Black, Onyx/Quicksilver (Met)	41U	96L	ZY4			x	x	Gunmetal/Silver
^ Black, Onyx/Red, Victory (Met)	41U	74L	ZY4	x				Beige/Black
^ Black, Onyx/Red, Victory (Met)	41U	74L	ZY4			x	x	Gunmetal/Silver
Blue, Green Med (Met)/Autumnwood, Lt (Met)	35U	55L	ZY4	x				Beige/Autumnwood
Blue, Green Med (Met)/Quicksilver (Met)	35U	96L	ZY4			x		Green/Silver
Blue, Lt (Met)/Quicksilver (Met)	27U	96L	ZY4		x	x		Lt Indigo/Dk Indigo
Blue, Royal Med (Met)/Autumnwood, Lt (Met)	25U	55L	ZY4	x				Beige/Black
Blue, Royal Med (Met)/Quicksilver (Met)	25U	96L	ZY4		x	x		Gunmetal/Silver
Green, Emerald (Met)/Quicksilver (Met)	43U	96L	ZY4			x		Green/Silver
Green, Emerald (Met)/Autumnwood, Lt (Met)	43U	55L	ZY4	x				Beige/Black
Quicksilver (Met)/Black, Onyx	96U	41L	ZY4			x	x	Gunmetal/Silver
Quicksilver (Met)/Blue, Lt (Met)	96U	27L	ZY4		x	x		Dk Indigo/Lt Indigo
Quicksilver (Met)/Blue, Green Med (Met)	96U	35L	ZY4			x		Green/Silver
Quicksilver (Met)/Blue, Royal Med (Met)	96U	25L	ZY4		x	x		Gunmetal/Silver
Quicksilver (Met)/Green, Emerald (Met)	96U	43L	ZY4			x		Gunmetal/Silver
Quicksilver (Met)/Red, Carmine Dk (Met)	96U	51L	ZY4			x	x	Gunmetal/Silver
^ Red, Carmine Dk (Met)/Autumnwood, Lt (Met)	51U	55L	ZY4	x				Beige/Autumnwood
^ Red, Carmine Dk (Met)/Autumnwood, Lt (Met)	51U	55L	ZY4				x	Beige/Silver
Red, Carmine Dk (Met)/Quicksilver (Met)	51U	96L	ZY4			x	x	Gunmetal/Silver
^ Red, Victory/Autumnwood, Lt (Met)	74U	55L	ZY4	x				Beige/Black
Red, Victory/Black, Onyx	74U	41L	ZY4			x		Beige/Black
^ Red, Victory/Quicksilver (Met)	74U	96L	ZY4			x	x	Gunmetal/Silver
^ Red, Victory/White, Summit	74U	50L	ZY4			x	x	Gunmetal/Silver
^ Red, Victory/White, Summit	74U	50L	ZY4	x				Beige/Black

* Leather on Seating Surface Only

**C/K1500 SPORT TRUCK PICKUP
INTERIOR AND EXTERIOR COLOR AVAILABILITY CHART
WITH ZY1 PAINT**

PLEASE NOTE: Below are the interior trim color and exterior paint combinations recommended by Chevrolet. They are the only available interior and exterior combinations allowed.

TRIM LEVEL (Must Specify Seat Option and Interior Color)		SEAT OPT	INTERIOR COLORS			
Seat Type			Neutral	Gray	Red	
Vinyl Bench Seat		A52	52V	13V	79V	
Custom Leather Bench Seat		A52	522	132	792	
Custom Cloth Reclining Split Bench Seat		AE7	52D	13D	79D	
Custom Leather Reclining Split Seat		AE7	522	132	792	
Custom Cloth Reclining High Back Bkt Seat		A95	52D	13D	79D	
EXTERIOR COLORS		Color Code	Paint Scheme	INTERIOR & EXTERIOR COMBINATIONS SHOWN ARE THE ONLY COMBINATIONS AVAILABLE		
BLACK, ONYX		41U	ZY1	x	x	x
RED, VICTORY		74U	ZY1	x	x	
WHITE, SUMMIT		50U	ZY1	x	x	x

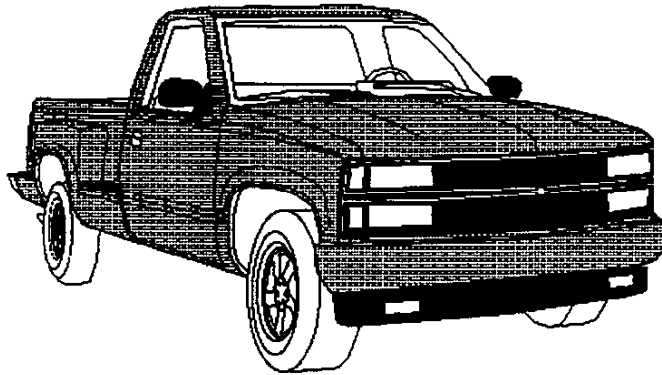

SOLID PAINT -- ZY1

NOTES

1997 NEW PRODUCT HIGHLIGHTS

CK2500 PICKUP

AIR BAG FOR FRONT PASSENGER ON ALL VEHICLES BELOW 8600# GVW

SPEED SENSITIVE POWER STEERING

NATURAL GAS PROVISIONS (OPT KL6) ON C20903

DEALERS WILL BE REQUIRED TO ORDER OPTION YG6 (AIR CONDITIONING NOT DESIRED) IF AIR CONDITIONING IS NOT ORDERED OR IS NOT STANDARD.

THREE NEW COLORS. GREEN BLUE METALLIC, ROYAL BLUE METALLIC AND DARK CARMINE RED METALLIC.



2500 PICKUP EQUIPMENT SUMMARY

STANDARD INTERIOR FEATURES

		CHEYENNE	SILVERADO
AIR BAGS:	DRIVER'S SIDE & <u>PASSENGER</u> (FRONT) (UNDER 8600 GVWR)	S	S
CUPHOLDERS:	DUAL IN DASH	S	S
DOOR BEAMS:	SIDE IMPACT	S	S
GAGES:	TRIP ODOMETER, OIL PRESSURE, VOLTMETER AND TACHOMETER	S	S
GLASS:	SOLAR RAY TINTED, ALL WINDOWS	S	S
JACK:	WITH WHEEL WRENCH	S	S
INSULATION:	UNDER DASH & FLOOR COVERING	S	S
LIGHTING:	DOME W/LH & RH DOOR SWITCH W/DELAYED ENTRY FEATURE, READING ASHTRAY, GLOVE-BOX, UNDERHOOD & CARGO LAMPS	S	S
POWER POINTS:	DUAL COVERED	S	S
SCOTCHGARD:	ALL CLOTH AND CARPET SURFACES	S	S
SEAT BELTS:	ADJUSTABLE HEIGHT, FRONT	S	S
WARNING TONE:	KEY-IN-IGNITION BUZZER	S	S

STANDARD EXTERIOR FEATURES

		CHEYENNE	SILVERADO
AIR DAM:	DARK ARGENT (UNDER 8600 GVW)	S	S
LAMPS:	DAYTIME RUNNING	S	S
FLARES:	WHEEL OPENING (K2500 W/C6P ONLY)	S	S
SPARE TIRE:	FULL SIZE TIRE & WHEEL, W/WINCH TYPE CARRIER MOUNTED UNDER REAR FRAME	S	S
TAILGATE:	REMOVABLE	S	S
TOW HOOKS:	TWO FRONT ON 4X4 MODELS	S	S
WIPERS:	INTERMITTENT WINDSHIELD W/PULSE WASHERS	S	S
WIRE HARNESS:	7 LEAD TRAILERING	S	S
WINDOW:	REAR QUARTER SWING-OUT (EXT CAB ONLY)	S	S

STANDARD CHASSIS FEATURES

		CHEYENNE	SILVERADO
BATTERY:	HEAVY-DUTY 600 CCA	S	S
BRAKES:	POWER ASSISTED FRONT DISC, REAR DRUM 4-WHEEL ANTI-LOCK	S	S
ENGINE:	VORTEC 5000 V8 SFI (W/CC20903 & CC20753) VORTEC 5700 V8 SFI (W/O CC20903 & CC20753)	S	S
EXHAUST SYSTEM:	STAINLESS STEEL	S	S
FUEL TANK:	25 GAL W/SHORT BOX MODELS 34 GAL W/LONG BOX MODELS	S	S
GENERATOR:	100 AMP	S	S
<i>STEERING:</i>	<i>SPEED SENSITIVE POWER (EVO)</i>	S	S
STORAGE BOX:	UNDERHOOD, COVERED	S	S
SUSPENSION FRT:	INDEPENDENT COIL W/2WD INDEPENDENT TORSION BAR W/4X4	S	S
SUSPENSION RR:	MULTI-LEAF SPRINGS	S	S
TRANSMISSION:	5-SPEED MANUAL W/OVERDRIVE	S	S

BOLD, ITALICS AND UNDERLINED INDICATES NEW FOR '97

**2500 PICKUP
TRIM DEFINITION & OPTION SUMMARY**

INTERIOR TRIM

		CHEYENNE:	SILVERADO
AIR CONDITIONING:		--	S
ASSIST HANDLES:	PASSENGER	S	S
CONVENIENCE GP:	POWER WINDOWS AND LOCKS	--	S
	TILT WHEEL AND CRUISE CONTROL	--	S
DOOR TRIM:	MOLDED PLASTIC W/ARMREST	S	--
	COLOR-KEYED CLOTH AND CARPET TRIMMED	--	S
FLOOR COVERING:	COLOR-KEYED CARPET	--	S
	COLOR-KEYED RUBBER	S	--
	RUBBER FLOOR MATS	--	S
HEADLINER:	COLOR-KEYED CLOTH	S	S
INSULATION:	ADDITIONAL SOUND-DEADENING	--	S
MAP POCKETS:	IN PASSENGER AND DRIVER'S DOOR	S	S
RADIO:	AM/FM STEREO W/SEEK-SCAN AND CLOCK	S	--
	AM/FM STEREO W/SEEK-SCAN, CLOCK AND CASSETTE TAPE	--	S
SEATING:	CLOTH BENCH	--	S
	VINYL BENCH (N/A EXT CAB)	S	--
	CLOTH 60/40 SPLIT BENCH (EXT CAB)	--	S
	VINYL 60/40 SPLIT BENCH (EXT CAB)	S	--
STEERING WHEEL:	SIMULATED LEATHER	S	--
	LEATHER WRAPPED	--	S
STORAGE TRAY:	FULL WIDTH BEHIND SEAT	--	S
SUNSHADES:	CLOTH COVERED W/LH STORAGE STRAP, W/RH MIRROR	S	S

EXTERIOR TRIM

		CHEYENNE	SILVERADO
BUMPER FRT:	CHROME	S	--
	CHROME W/BLACK RUB STRIP	--	S
BUMPER RR:	CHROME W/STEP PAD	--	S
GRILLE:	MOLDED, PAINTED ARGENT	S	--
	CHROME DELUXE	--	S
HEADLAMPS:	SINGLE RECTANGULAR HALOGEN	S	--
	DUAL COMPOSITE - HALOGEN	--	S
HORN:	SINGLE NOTE	S	--
	DUAL NOTE	--	S
MIRRORS:	BREAK-A-WAY OSRV, BLACK	S	--
	ELECTRIC, REMOTE CONTROL, BLACK	--	S
MOLDINGS:	BODY SIDE WITH BRIGHT TRIM AND BRIGHT WHEEL OPENING TRIM (C2500 OR K2500 W/O C6P)	--	S
NAMEPLATES:	CHEYENNE BADGE ON B-PILLAR	S	--
	SILVERADO BADGE ON B-PILLAR	--	S
PAINT:	SINGLE TONE	S	--
WHEELS:	SILVER PAINTED W/BLACK CENTER CAP	S	--
	RALLY WHEEL TRIM	--	S

BOLD, ITALICS AND UNDERLINED INDICATES NEW FOR '97

MODEL AND BODY

Description	Model No	Body	Wheel Base
2-WHEEL-DRIVE MODEL			
Fleetside	CC20903	E63	131.5
Fleetside	CC20903	E63 & C6P	131.5
Fleetside, Ext Cab	CC20753	E63	141.5
Fleetside, Ext Cab	CC20953	E63 & C6P	155.5

Description	Model No	Body	Wheel Base
4-WHEEL-DRIVE MODEL			
Fleetside	CK20903	E63 & C6P	131.5
Fleetside, Ext Cab	CK20753	E63 & C6P	141.5
Fleetside, Ext Cab	CK20953	E63 & C6P	155.5

*Includes Destination & Handling Charges

EMISSIONS (Must Specify One) (Refer Emission Requirements Section)

FE9 Federal Emission Requirements

YF5 California Emission Requirements

NG1 New York/Massachusetts Emission Requirements

NB8 California or New York/Massachusetts Emission Override (Reqs FE9 Federal Emissions)

NC7 Federal Emission Override (Reqs YF5 California or NG1 New York/Massachusetts Emissions)

GVWR SELECTOR (Must Specify GVW Option)

Minimum Equipment Required for GVW Rating

GVW Option Required	GVW Rating (lbs)	GAWR*		
		Front	Rear	
C20903				
C5Z	7200	3150	4670	Reqs L30 or L31 Eng
C5Z	7200	3400	4670	Reqs L56 Eng
C6P	8600	3600	6000	Reqs C6P & YHH or YGK
K20903				
C6P	8600	4250	6000	Reqs C6P & YHH or YGK
C20753				
C5Z	7200	3600	4670	N/A L65 Eng
C20953				
C6P	8600	3600	6000	Reqs C6P & YHH or YGK
K20753/K20953				
C6P	8600	4250	6000	Reqs C6P & YHH or YGK

*GAWR's shown are the minimum for each axle with equipment listed. Other GAWR's are available, and they are determined as the minimum capacity of either axle, springs or tires.

POWER TEAMS (Must Specify Engine, Transmission and Rear Axle)

(Consult GVWR Selector For Minimum Equipment Required)

ENGINE	TRANSMISSION		AXLE			GVWR
	5-SP	AUTO	3.42	3.73	4.10	
	Lt Duty / H Duty	Lt Duty / H Duty				
CC20903						
L30 Vortec 5000 V8 (305 Cu In)-SFI	MG5		(a) GU6	(a) GT4	--	7200
		M30	GU6	GT4	--	7200
L31 Vortec 5700 V8 (350 Cu In)-SFI	M50	M30	GU6	GT4	--	7200
L31 Vortec 5700 V8 H. D. (350 Cu In)-SFI	MW3		--	(a) GT4	(a) GT5	8600
		MT1	--	GT4	GT5	8600
L29 Vortec 7400 V8 H.D. (454 Cu In)-SFI	MW3		--	(a) GT4	(a) GT5	8600
		MT1	--	GT4	GT5	8600
L56 Turbo Diesel 6.5 Liter V8 (400 Cu In)		MT1	(a) GU6	(a) GT4	--	7200
L65 Turbo Diesel 6.5 Liter V8 H.D. (400 Cu In)	MW3	MT1	--	GT4	GT5	8600
CK20903						
L31 Vortec 5700 V8 H.D. (350 Cu In)-SFI	MW3		--	(a) GT4	(a) GT5	8600
		MT1	--	GT4	GT5	8600
L29 Vortec 7400 V8 H.D. (454 Cu In)-SFI	MW3		--	(a) GT4	(a) GT5	8600
		MT1	--	GT4	GT5	8600
L65 Turbo Diesel 6.5 Liter V8 H.D. (400 Cu In)	MW3	MT1	--	GT4	GT5	8600

(a) N/A YF5 California Emissions

POWER TEAMS (Must Specify Engine, Transmission and Rear Axle)

(Consult GVWR Selector For Minimum Equipment Required)

ENGINE	TRANSMISSION		AXLE			GVWR
	5-SP	AUTO	3.42	3.73	4.10	
	Lt Duty / H Duty	Lt Duty / H Duty				
CC20753						
L30 Vortec 5000 V8 (305 Cu In)-SFI	MG5		(a) GU6	--	--	7200
		M30	GU6	GT4	--	7200
L31 Vortec 5700 V8 (350 Cu In)-SFI	M50	M30	GU6	GT4	--	7200
L56 Turbo Diesel V8 6.5 Liter (400 Cu In)		MT1	(a) GU6	(a) GT4	--	7200
CC20953						
L31 Vortec 5700 V8 H.D. (350 Cu In)-SFI	MW3		--	(a) GT4	(a) GT5	8600
		MT1	--	GT4	GT5	8600
L29 Vortec 7400 V8 H.D. (454 Cu In)-SFI	MW3		--	(a) GT4	(a) GT5	8600
		MT1	--	GT4	GT5	8600
L65 Turbo Diesel H.D. 6.5 Liter V8 (400 Cu In)	MW3	MT1		GT4	GT5	8600
CK20753 /CK20953						
L31 Vortec 5700 V8 H.D. (350 Cu In)-SFI	MW3		--	(a) GT4	(a) GT5	8600
		MT1	--	GT4	GT5	8600
L29 Vortec 7400 V8 H.D. (454 Cu In)-SFI	MW3		--	(a) GT4	(a) GT5	8600
		MT1	--	GT4	GT5	8600
L65 Turbo Diesel H.D. 6.5 Liter V8 (400 Cu In)	MW3	MT1	--	GT4	GT5	8600

(a) N/A YF5 California Emissions

CAPACITIES

C20903

SPRINGS:	AXLES:
Front	Front
2150 Base	3150 Base
3400 w/Diesel Eng	3400 w/Diesel Eng
3600 w/C6P	3800 w/C6P
Rear	Rear
4800 Base	4800 Base
6084 w/C6P	6000 w/C6P

K20903

SPRINGS:	AXLES:
Front	Front
4250 w/C6P	4250 w/C6P
Rear	Rear
4800 Base	4800 Base
6084 w/C6P	6000 w/C6P

C20753-C20953

SPRINGS:	AXLES:
Front	Front
3600 Base	3600 Base
	3800 w/C6P
Rear	Rear
4800 Base	4800 Base
6084 w/C6P	6000 w/C6P

K20953

SPRINGS:	AXLES:
Front	Front
3925 Base	3925 Base
4250 w/C6P	4250 w/C6P
Rear	Rear
4800 Base	4800 Base
6084 w/C6P	6000 w/C6P

TIRES: (Must Specify Front and Rear) (Spare Tire and Tire Carrier Included) (Spare Matches Rear Tire)

Description	All Season		On-Off Road	
	Front	Rear	Front	Rear
C20903				
TUBELESS Steel Belted Radial				
(a)LT225/75R16-D B/W	XHP	YHP		
(a)LT225/75R16-D B/W	XHP			YHR
LT245/75R16-E B/W	XHH	YHH		
LT245/75R16-E B/W	XHH			YGK
K20903				
TUBELESS Steel Belted Radial				
LT245/75R16-E B/W			XGK	YGK
LT245/75R16-E B/W	XHH	YHH		
C20753				
TUBELESS Steel Belted Radial				
LT225/75R16-D B/W	XHP	YHP		
LT225/75R16-D B/W	XHP			YHR
LT245/75R16-E B/W	XHH	YHH		
LT245/75R16-E B/W	XHH			YGK
C20953				
TUBELESS Steel Belted Radial				
LT245/75R16-E B/W	XHH	YHH		
LT245/75R16-E B/W	XHH			YGK
K20753-K20953				
TUBELESS Steel Belted Radial				
LT245/75R16-E B/W			XGK	YGK
LT245/75R16-E B/W	XHH	YHH		

(a)N/A C6P 8600 GVWR

WOL = White Outlined Letter
B/W = Blackwall

MUST SPECIFY:

AXLE, EMISSION, ENGINE, TIRES AND TRANSMISSION

**No Deletions Allowed. Additional Options/Upgrades (Where Indicated)
May be Ordered from the Custom Ordering Options Listing.**

	Reg & Ext Decor		
	CHEYENNE	SILVERADO	
	1 S A	1 S B	1 S C
CHEYENNE DECOR.....	X	--	--
Fleetside Body Code E63	X	X	X
SILVERADO DECOR..... YE9		X	X
SILVERADO DECOR (Leather)			
Regular Cab			
Extended Cab			
Keyless Entry			X
Mirror, 10" Electrochromic ISRV w/8 Point Compass			X
Seat, Power (A)			X
Trim, Leather (B)			X

(A) Extended Cab Only

(B) Must Specify Trim Color. May Upgrade to A95 Seat on Extended Cab

Preferred Equipment Group Prices

- N.C. 1SA
- PEG Savings
- **(-700.00) w/R9A & R9B
- **(-500.00) w/R9A
- **(-200.00) w/R9B or R9C
- N.C. w/o R9A, R9B or R9C

Preferred Equipment Group Prices

- **(-750.00) 1SB or 1SC

**PEG Savings Amount represents the savings for Preferred Equipment Groups.

REGULAR CAB MARKETING PACKAGES

CONVENIENCE PACKAGE

ORDERING OPTION=R9A

(Reqs Peg 1SA)

Incls :

C60 Air Conditioning
 UM6 Radio w/Cassette
 ZQ3 Tilt and Cruise

BRIGHT APPEARANCE PACKAGE

4-Wheel Drive

2-Wheel Drive

ORDERING OPTION=R9B

(Reqs Peg 1SA)

Incls :

B85 Body Side Moldings
 V22 Chrome Grille
 VB3 Chrome Rear Step Bumper
 VG3 Chromed Front Bumper
 P06 Wheel Trim

COMMERCIAL OPTION PACKAGE

2-Wheel Drive

4-Wheel Drive Diesel Eng

4-Wheel Drive Gas Eng

ORDERING OPTION=R9C

(Reqs Peg 1SA) (N/A R9B Bright Appearance Pkg)

Incls :

BZY Bedliner
 E63 Fleetside
 V43 Painted Step Bumper
 F60 HD Front Springs (K Models Only)
 V76 Tow Hooks (C Models Only)
 NZZ Skid Plate (K Models Only)
 A28 Sliding Rear Window

EXTENDED CAB MARKETING PACKAGES

CONVENIENCE PACKAGE

ORDERING OPTION=R9A

(Reqs Peg 1SA)

Incls :

C60 Air Conditioning
 UM6 Radio w/Cassette
 ZQ3 Tilt and Cruise

BRIGHT APPEARANCE PACKAGE

4-Wheel Drive

2-Wheel Drive

ORDERING OPTION=R9B

(Reqs Peg 1SA)

Incls :

B85 Body Side Moldings
 V22 Chrome Grille
 VB3 Chrome Rear Step Bumper
 VG3 Chromed Front Bumper
 P06 Rally Wheels

COMMERCIAL OPTION PACKAGE

2-Wheel Drive

4-Wheel Drive Diesel Eng

4-Wheel Drive Gas Eng

ORDERING OPTION=R9C

(Reqs Peg 1SA) (N/A R9B Bright Appearance Pkg)

Incls :

BZY Bedliner
 E63 Fleetside
 V43 Painted Step Bumper
 F60 HD Front Springs (K Models Only)
 V76 Tow Hooks (C Models Only)
 NZZ Skid Plate (K Models Only)
 A28 Sliding Rear Window

ADDITIONAL OPTIONS

INCL W/DECOR		OPTION
CHEY- ENNE	SILVER- ADO	
		ACKNOWLEDGEMENTS: R8S Multiple Order Numbers R8T Preliminary Invoice (Refer Vehicle Price Schedule for Prices) K47 AIR CLEANER: High Capacity (N/A L56 Eng) AIR CONDITIONING: (One Of The Following Options Must Be Ordered w/PEG 1SA w/o Convenience Pkg R9A) YG6 Air Conditioning Not Desired C60 Air Conditioning: (Incls R134A Refrigerant) w/1SB or 1SC or R9A w/1SA
	x	V22 APPEARANCE PACKAGE: (Incls Chrome Grille, Composite Halogen Headlamps and Dual Horns) w/1SB, 1SC or R9B w/1SA
	x	AXLES, REAR: (Refer Power Teams Chart for Availability) GU6 3.42 Ratio (Incls Eng Oil Cooler w/Diesel Eng) GT4 3.73 Ratio (Incls Eng Oil Cooler) w/C6P w/C5Z
		GT5 4.10 Ratio (Incls Eng Oil Cooler) G80 Locking Differential (N/A GU6 Axle) TP2 BATTERY: Heavy-Duty, Auxiliary (Reqs L29, L30, or L31 Eng) (Deletes Underhood Storage Box) BZY BEDLINER: Under Rail w/R9C w/o R9C
		E63 BODY: Fleetside BUMPER EQUIPMENT: (Vehicles registered in certain states must have a rear bumper to be operated on their roads. Consult your local laws.) (Cheyenne Decor does not include a Rear Bumper)
N/A	x	EF1 Bumper Delete Provisions: VB3 Bumper, Chromed. Rear Step w/Rub Strip (Reqs VG3 Bumper or Silverrader Decor) w/1SB, 1SC or R9B w/o 1SB, 1SC or R9B
	x	VG3 Bumper, Chromed. Front Deluxe w/Rub Strip w/1SB, 1SC or R9B w/o 1SB, 1SC or R9B
	N/A	V43 Bumper, Painted. Rear Step w/R9C w/o R9C
	x	V10 COLD-CLIMATE PACKAGE: (Incls Eng Block Heater) (Diesel Eng Reqs Base Decor and Regular Cab) ZQ3 CONVENIENCE GROUP: Tilt-Wheel and Speed Control w/1SB, 1SC or R9A w/o 1SB, 1SC or R9A
		COOLING SYSTEM: (Incl w/Z82 Trailering Where Available) (Engine Oil Cooler Comparable to KC4 is Standard w/o GU6 Axle) KC4 Engine Oil (N/A Diesel Eng, GT4 Axle or C6P GVW) w/Z82 w/o Z82
		KNP Transmission, Heavy-Duty Auxiliary (Reqs L31 Eng & M30 Trans) (Incl w/MT1 Trans or w/Z82 Trailering when L31 Eng and M30 Trans are ordered) w/MT1 or w/Z82 & Auto Trans w/o MT1 or w/o Z82 & Auto Trans
N/A		C49 DEFOGGER: Electric Rear Window (N/A A28 Window or C-K20903) EMISSIONS: (Refer Emission Requirement Tab Section) FE9 Federal Emission Requirements YF5 California Emission Requirements NG1 New York/Massachusetts Emission Requirements NB8 California or New York/Massachusetts Emission Override (Reqs FE9 Federal Emissions) NC7 Federal Emission Override (Reqs YF5 California or NG1 New York/Massachusetts Emissions)
		ENGINES: (Refer Power Teams Chart for Availability) L30 Vortec 5000 V8 (305 Cu In)-SFI L31 Vortec 5700 V8 (350 Cu In)-SFI w/C6P w/o C6P
		L29 Vortec 7400 V8 (454 Cu In)- SFI L56 6.5 Liter V8 Turbo Diesel (400 Cu In) (Deletes Underhood Storage Box) L65 6.5 Liter V8 Turbo Diesel (400 Cu In) KL5 Alternative Fuel (LPG and CNG Conversion Ready) (Reqs L31 Eng, C6P GVW and Auto Trans) (N/A C20753)

PREMIUM VALVES
HARDEN VALVES SEATS

ADDITIONAL OPTIONS

INCL W/DECOR		OPTION
CHEV- ENNE	SILVER- ADD	
N/A		FLOOR COVERING: BG9 Full Floor, Rubber, Color-Keyed (Replaces Carpeting and Floor Mats) (N/A BYP Sport Pk{t}) w/CK10*03 w/CK10*53
	N/A	B30 Carpet Floor Covering w/CK10*03 w/CK10*53
	N/A	B32 Floor Mats, Front (Reqs B30 Floor Covering)
	N/A	B33 Floor Mats, Rear (N/A YG4 Seat Delete) (Reqs B30 Carpet, B32 Floor Mats and C-K***53)
		AJ1 GLASS: Deep Tinted Solar-Ray (With C49 Defogger, Rear Window is Light Tint Glass) (C-K20903 Reqs A28 Sliding Rear Window) C***03wA28 C***53wC49 w/o C49
		GVWR: (Must Specify One) (Refer GVWR Selector Chart for Availability) C5Z 7200# C6P 8600#
N/A		AU0 KEYLESS ENTRY: Remote w/1SC w/o 1SC
		U01 LAMPS: Roof Marker (N/A YF5 Calif Emissions)
	N/A	VK3 LICENSE PLATE BRACKET: Front
		AU3 LOCKS: Power Door w/1SB or 1SC w/o 1SB or 1SC
		MIRRORS: DF2 Camper Type, Stainless Steel, 7.5" W x 10.5" H, Exterior w/1SB or 1SC w/1SA
N/A		DD7 10" Electrochromic ISRV with 8 Point Compass, Interior w/1SC w/1SB
	x	B85 MOLDING: Exterior, Bright (Incls Body Side and Wheel Opening) (K2500 w/C6P Incls Body Side Mldg Only) w/1SB, 1SC or R9B K2500 C2500
		PAINT, EXTERIOR: (Refer Color and Trim Chart for Availability) ZY1 Solid ZY2 Conventional Two-Tone ZY4 Deluxe Two-Tone
N/A		
N/A		RADIO EQUIPMENT: x UM6 Electronically Tuned AM/FM Stereo Radio w/Seek-Scan, Digital Clock and Cassette Tap w/1SB, 1SC or RSA w/1SA w/o RSA
N/A		UL0 Electronically Tuned AM/FM Stereo Radio w/Seek-Scan, Digital Clock, Automatic Tone Control, Cassette Tape, Theft Lock and Speed Compensated Volume (Incls an Enhanced Performance Speaker System)
N/A		UN0 Electronically Tuned AM/FM Stereo Radio w/Seek-Scan, Digital Clock, Automatic Tone Control, Compact Disc Player, Theft Lock and Speed Compensated Volume (w/Silverado Decor Incls an Enhanced Performance Speaker System)
N/A		UP0 Electronically Tuned AM/FM Stereo Radio w/Seek-Scan, Digital Clock, Automatic Tone Control, Stereo Cassette Tape w/Search and Repeat, Compact Disc Player, Theft Lock and Speed Compensated Volume (w/Silverado Decor Incls an Enhanced Performance Speaker System) (Reqs M30 or MT1 Trans)
	N/A	UL5 Radio Delete
N/A		AG9 SEAT: Power Driver's Seat (N/A Vinyl Trim or A52 Bench Seat) (N/A C-K 20903) w/1SC w/o 1SC
	N/A	YG4 SEAT DELETE: Rear (N/A C-K20903)
		SEAT TYPE: (Refer Color/Trim Chart for Availability) A52 Bench Seat (Incls Storage Armrest and Power Lumbar w/Custom Cloth or Leather Trim) w/1SA or 1SB w/o Leather w/1SB with Leather
		AE7 Reclining 60/40 Split Bench Seat (Incls Storage Armrest and Power Lumbar w/Custom Cloth or Leather Trim) w/1SC Extended Cab w/1SA or 1SB w/o Leather w/1SB and Leather Regular Cab w/1SA or 1SB w/o Leather w/1SB and Leather

**C/K 2500 PICKUP
PAINT APPLICATIONS
WITH ZY1, ZY2 AND ZY4 PAINT SCHEMES**

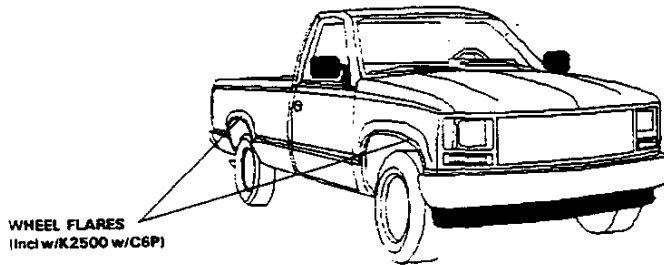

SOLID PAINT - ZY1

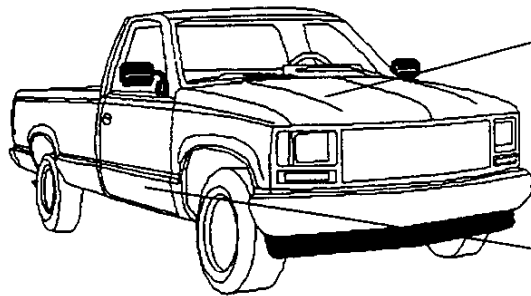

CONVENTIONAL TWO-TONE PAINT - ZY2

COLOR CODE 1

WHEEL FLARE

COLOR CODE 2

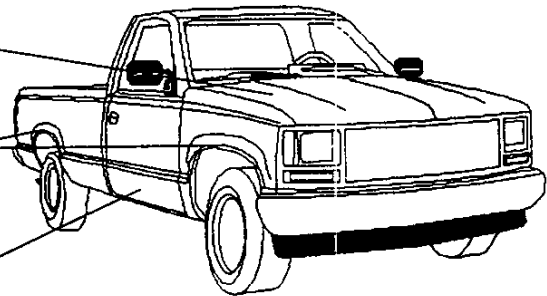

**CONVENTIONAL TWO-TONE PAINT - ZY2
K2500 w/C6P**

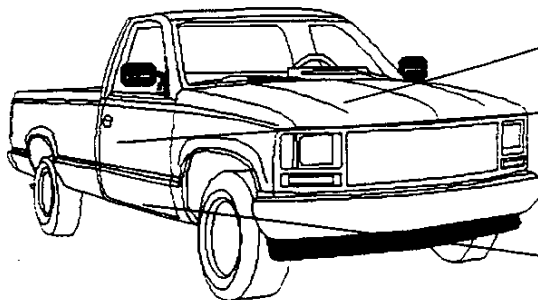

**DELUXE TWO-TONE PAINT - ZY4
(Includes Body Striping)**

COLOR CODE 1

COLOR CODE 2

WHEEL FLARE

COLOR CODE 1

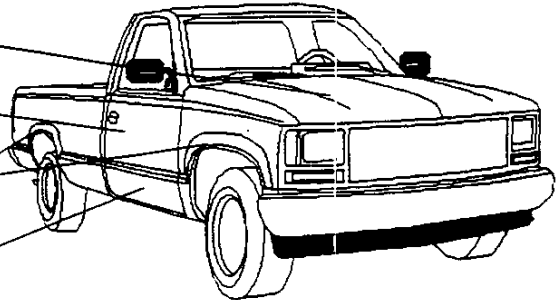

**DELUXE TWO-TONE PAINT - ZY4
(Includes Body Striping)
K2500 w/C6P**

C/K 2500 PICKUP INTERIOR AND EXTERIOR COLOR AVAILABILITY CHART WITH ZY1 PAINT SCHEMES

PLEASE NOTE: Below are the interior trim color and exterior paint combinations recommended by Chevrolet. They are the only available interior and exterior combinations allowed.

TRIM LEVEL (Must Specify Seat Option and Interior Color) Seat Type	SEAT OPT	INTERIOR COLORS					
		Neutral	Blue	Gray	Red		
CHEYENNE (STD DECOR)							
REGULAR CAB							
Vinyl Bench Seat	A52	52V	26V	13V	79V		
Cloth Bench Seat	A52	52C	26C	13C	79C		
EXTENDED CAB							
Vinyl Reclining Split Bench Seat	AE7	52V	26V	13V	79V		
Cloth Reclining Split Bench Seat	AE7	52C	26C	13C	79C		
SILVERADO DECOR							
REGULAR CAB							
Vinyl Bench Seat	A52	52V	26V	13V	79V		
Custom Cloth Bench Seat	A52	52D	26D	13D	79D		
* Custom Leather Bench Seat	A52	522	262	132	792		
Custom Cloth Reclining Split Bench Seat	AE7	52D	26D	13D	79D		
* Custom Leather Reclining Split Bench Seat	AE7	522	262	132	792		
Custom Cloth Reclining High Back Bkt Seats	A95	52D	26D	13D	79D		
EXTENDED CAB							
Vinyl Reclining Split Bench Seat	AE7	52V	26V	13V	79V		
Custom Cloth Reclining Split Bench Seat	AE7	52D	26D	13D	79D		
* Custom Leather Reclining Split Bench Seat	AE7	522	262	132	792		
Custom Cloth Reclining High Back Bkt Seats	A95	52D	26D	13D	79D		
* Custom Leather Reclining High Back Bkt Seats	A95	522	262	132	792		
EXTERIOR COLORS		Color Code	PAINT SCHEME	INTERIOR & EXTERIOR COMBINATIONS SHOWN ARE THE ONLY COMBINATIONS AVAILABLE			Wheel Flare Colors Avail or Std on 4-WD 8600 GVWR
^ AUTUMNWOOD, LT (Metallic)		55U	ZY1	x			Autumnwood, Lt
BLACK, ONYX		41U	ZY1	x		x	Black, Onyx
^ BLUE, GREEN MED (Metallic)		35U	ZY1	x		x	Dk Argent
BLUE, LT (Metallic)		27J	ZY1		x	x	Dk Argent
BLUE, ROYAL MED (Metallic)		25U	ZY1	x	x	x	Blue, Royal Med
GREEN, EMERALD (Metallic)		43J	ZY1	x		x	Dk Argent
QUICKSILVER (Metallic)		96U	ZY1		x	x	Quicksilver
RED, CARMINE DK (Metallic)		51U	ZY1	x		x	Red, Carmine Dk
RED, VICTORY		74J	ZY1	x		x	Dk Argent
WHITE, SUMMIT		50U	ZY1	x	x	x	Dk Argent

* Leather on Seating Surface Only

C/K 2500 PICKUP
INTERIOR AND EXTERIOR COLOR AVAILABILITY CHART
ZY2 PAINT SCHEMES

TRIM LEVEL (Must Specify Seat Option and Interior Color) Seat Type	SEAT OPT	INTERIOR COLOR			
		Neutral	Blue	Gray	Red
SILVERADO DECOR					
REGULAR CAB					
Vinyl Bench Seat	A52	52V	26V	13V	79V
Custom Cloth Bench Seat	A52	52D	26D	13D	79D
* Custom Leather Bench Seat	A52	522	262	132	792
Custom Cloth Reclining Split Bench Seat	AE7	52D	26D	13D	79D
* Custom Leather Reclining Split Bench Seat	AE7	522	262	132	792
Custom Cloth Reclining High Back Bkt Seats	A95	52D	26D	13D	79D
EXTENDED CAB					
Vinyl Reclining Split Bench Seat	AE7	52V	26V	13V	79V
Custom Cloth Reclining Split Bench Seat	AE7	52D	26D	13D	79D
* Custom Leather Reclining Split Bench Seat	AE7	522	262	132	792
Custom Cloth Reclining High Back Bkt Seats	A95	52D	26D	13D	79D
* Custom Leather Reclining High Back Bkt Seats	A95	522	262	132	792

EXTERIOR COLORS	Color Code 1	Color Code 2	PAINT SCHEME	INTERIOR & EXTERIOR COMBINATIONS SHOWN ARE THE ONLY COMBINATIONS AVAILABLE				Wheel Flare Colors Avail or Std on (s) 4-WD
Autumnwood, Lt (Met)/Red, Carmine Dk (Met)	55U	51L	ZY2	x			x	Red, Carmine Dk
Black, Onyx/Autumnwood, Lt (Met)	41U	55L	ZY2	x				Autumnwood, Lt
Black, Onyx/Quicksilver (Met)	41U	96L	ZY2			x	x	Quicksilver
+ Black, Onyx/Red Victory (Met)	41U	74L	ZY2	x		x	x	N/A
Blue, Green Med (Met)/Autumnwood, Lt (Met)	35U	55L	ZY2	x				Autumnwood, Lt
Blue, Green Med (Met)/Quicksilver (Met)	35U	96L	ZY2			x		Quicksilver
Blue, Lt (Met)/Quicksilver (Met)	27U	96L	ZY2			x		Quicksilver
Blue, Royal Med (Met)/Autumnwood, Lt (Met)	25U	55L	ZY2	x	x			Autumnwood, Lt
Blue, Royal Med (Met)/Quicksilver (Met)	25U	96L	ZY2		x	x		Quicksilver
Green, Emerald (Met)/Autumnwood, Lt (Met)	43U	55L	ZY2	x				Autumnwood, Lt
Green, Emerald (Met)/Quicksilver (Met)	43U	96L	ZY2			x		Quicksilver
Quicksilver (Met)/Black, Onyx	96U	41L	ZY2			x	x	Black, Onyx
+ Quicksilver (Met)/Blue, Lt (Met)	96U	27L	ZY2		x	x		N/A
Quicksilver (Met)/Blue, Royal Med (Met)	96U	25L	ZY2		x	x		Blue, Royal Med
+ Quicksilver (Met)/Green, Emerald (Met)	96U	43L	ZY2			x		N/A
Quicksilver (Met)/Red, Carmine Dk (Met)	96U	51L	ZY2			x	x	Red, Carmine Dk
+ Quicksilver (Met)/Red, Victory (Met)	96U	74L	ZY2			x		N/A
Red, Carmine Dk (Met)/Autumnwood, Lt (Met)	51U	55L	ZY2	x			x	Autumnwood, Lt
Red, Carmine Dk (Met)/Quicksilver (Met)	51U	96L	ZY2			x	x	Quicksilver
Red, Victory/Autumnwood, Lt (Met)	74U	55L	ZY2	x				Autumnwood, Lt
Red, Victory/Black, Onyx	74U	41L	ZY2	x			x	Black, Onyx
Red, Victory/Quicksilver (Met)	74U	96L	ZY2			x		Quicksilver
White, Summit/Autumnwood, Lt (Met)	50U	55L	ZY2	x				Autumnwood, Lt
+ White, Summit/Blue, Lt (Met)	50U	27L	ZY2		x	x		N/A
White, Summit/Blue, Royal Med (Met)	50U	25L	ZY2		x	x		Blue, Royal Med
White, Summit/Red, Carmine Dk (Met)	50U	51L	ZY2				x	Red, Carmine Dk

* Leather on Seating Surface Only
+ N/A K3500

C/K 2500 PICKUP INTERIOR AND EXTERIOR COLOR AVAILABILITY CHART ZY4 PAINT SCHEMES

PLEASE NOTE: Below are the interior trim color and exterior paint combinations recommended by Chevrolet. They are the only available interior and exterior combinations allowed.

TRIM LEVEL (Must Specify Seat Option and Interior Color) Seat Type	SEAT OPT	INTERIOR COLORS			
		Neutral	Blue	Gray	Red
SILVERADO DECOR					
REGULAR CAB					
Vinyl Bench Seat	A52	52V	26V	13V	79V
Custom Cloth Bench Seat	A52	52D	26D	13D	79D
* Custom Leather Bench Seat	A52	522	262	132	792
* Custom Cloth Reclining Split Bench Seat	AE7	52D	26D	13D	79D
* Custom Leather Reclining Split Bench Seat	AE7	522	262	132	792
Custom Cloth Reclining High Back Bkt Seats	A95	52D	26D	13D	79D
EXTENDED CAB					
Vinyl Reclining Split Bench Seat	AE7	52V	26V	13V	79V
Custom Cloth Reclining Split Bench Seat	AE7	52D	26D	13D	79D
* Custom Leather Reclining Split Bench Seat	AE7	522	262	132	792
Custom Cloth Reclining High Back Bkt Seats	A95	52D	26D	13D	79D
* Custom Leather Reclining High Back Bkt Seats	A95	522	262	132	792

EXTERIOR COLORS	Color Code 1	Color Code 2	PAINT SCHEME	INTERIOR & EXTERIOR COMBINATIONS SHOWN ARE THE ONLY COMBINATIONS AVAILABLE				STRIPE COLORS Top-Lower/Center
Autumnwood, Lt (Met)/Blue, Green Med (Met)	55U	35L	ZY4	x				Beige/Autumnwood
Autumnwood, Lt (Met)/Green, Emerald (Met)	55U	43L	ZY4	x				Beige/Autumnwood
Autumnwood, Lt (Met)/Red, Carmine Dk (Met)	55U	51L	ZY4	x			x	Beige/Autumnwood
Autumnwood, Lt (Met)/Red, Victory (Met)	55U	74L	ZY4	x				Beige/Black
Black, Onyx/Autumnwood, Lt (Met)	41U	55L	ZY4	x				Beige/Black
Black, Onyx/Quicksilver (Met)	41U	96L	ZY4			x	x	Gunmetal/Silver
^ Black, Onyx/Red, Victory (Met)	41U	74L	ZY4	x				Beige/Black
^ Black, Onyx/Red, Victory (Met)	41U	74L	ZY4			x	x	Gunmetal/Silver
Blue, Green Med (Met)/Autumnwood, Lt (Met)	35U	55L	ZY4	x				Beige/Autumnwood
+ Blue, Green Med (Met)/Quicksilver (Met)	35U	96L	ZY4			x		Green/Silver
+ Blue, Lt (Met)/Quicksilver (Met)	27U	96L	ZY4		x	x		Lt Indigo/Dk Indigo
Blue, Royal Med (Met)/Autumnwood, Lt (Met)	25U	55L	ZY4	x				Beige/Black
Blue, Royal Med (Met)/Quicksilver (Met)	25U	96L	ZY4		x	x		Gunmetal/Silver
+ Green, Emerald (Met)/Quicksilver (Met)	43U	96L	ZY4			x		Green/Silver
+ Green, Emerald (Met)/Autumnwood, Lt (Met)	43U	55L	ZY4	x				Beige/Black
Quicksilver (Met)/Black, Onyx	96U	41L	ZY4			x	x	Gunmetal/Silver
Quicksilver (Met)/Blue, Lt (Met)	96U	27L	ZY4		x	x		Dk Indigo/Lt Indigo
Quicksilver (Met)/Blue, Green Med (Met)	96U	35L	ZY4			x		Green/Silver
Quicksilver (Met)/Blue, Royal Med (Met)	96U	25L	ZY4		x	x		Gunmetal/Silver
Quicksilver (Met)/Green, Emerald (Met)	96U	43L	ZY4			x		Gunmetal/Silver
Quicksilver (Met)/Red, Carmine Dk (Met)	96U	51L	ZY4			x	x	Gunmetal/Silver
^ Red, Carmine Dk (Met)/Autumnwood, Lt (Met)	51U	55L	ZY4	x				Beige/Autumnwood
^ Red, Carmine Dk (Met)/Autumnwood, Lt (Met)	51U	55L	ZY4				x	Beige/Silver
Red, Carmine Dk (Met)/Quicksilver (Met)	51U	96L	ZY4			x	x	Gunmetal/Silver
+ Red, Victory/Autumnwood, Lt (Met)	74U	55L	ZY4	x				Beige/Black
+ Red, Victory/Black, Onyx	74U	41L	ZY4			x		Beige/Black
+ Red, Victory/Quicksilver (Met)	74U	96L	ZY4			x	x	Gunmetal/Silver
+ Red, Victory/White, Summit	74U	50L	ZY4			x	x	Gunmetal/Silver
+ Red, Victory/White, Summit	74U	50L	ZY4	x				Beige/Black

* Leather on Seating Surface Only
+ N/A K2500 w/C6P

Wheel Flare Colors Using Color Code 1	
Available or Std on 4-WD 8600 GVWR	
25U	Blue, Royal Med
27U	N/A
35U	N/A
41U	Black, Onyx
43U	N/A
51U	Red, Carmine Dk
55U	Autumnwood, Lt
74U	N/A
96U	Quicksilver

REVISED: 12-16-96

1997 ORDER GUIDE

C/K 2500 PICKUP

^ Indicates Change

Page 15

Prices Shown Are Manufacturer's Suggested Retail Prices (MSRP) At The Time Of Publication. These Prices Are To Be Used Only As An Aid To Inventory Management Since MSRP Figures Change Periodically. The Vehicle Price Schedule Is The Official Pricing Documentation Of Chevrolet Motor Division And Should Be Used In Discussing Vehicle Prices With Potential Buyers. The Model Prices Shown In The Order Guide Include The Destination Freight Charges.

NOTES

1997 NEW PRODUCT HIGHLIGHTS

CK3500 PICKUP

SPEED SENSITIVE POWER STEERING

DEALERS WILL BE REQUIRED TO ORDER OPTION YG6 (AIR CONDITIONING NOT DESIRED) IF AIR CONDITIONING IS NOT ORDERED OR IS NOT STANDARD.

THREE NEW COLORS. GREEN BLUE METALLIC, ROYAL BLUE METALLIC AND DARK CARMINE RED METALLIC.



3500 PICKUP EQUIPMENT SUMMARY

STANDARD INTERIOR FEATURES

		CHEYENNE	SILVERADO
CUPHOLDERS:	DUAL IN DASH	S	S
DOOR BEAMS:	SIDE IMPACT	S	S
GAGES:	TRIP ODOMETER, OIL PRESSURE, VOLTMETER AND TACHOMETER	S	S
GLASS:	SOLAR RAY TINTED, ALL WINDOWS	S	S
JACK:	WITH WHEEL WRENCH	S	S
INSULATION:	UNDER DASH & FLOOR COVERING	S	S
LIGHTING:	DOME W/LH & RH DOOR SWITCH W/DELAYED ENTRY FEATURE, READING, ASHTRAY, GLOVE-BOX, UNDERHOOD & CARGO LAMP	S	S
POWER POINTS:	DUAL COVERED	S	S
SCOTCHGARD:	ALL CLOTH AND CARPET SURFACES	S	S
SEAT BELTS:	ADJUSTABLE HEIGHT, FRONT	S	S
WARNING TONE:	KEY-IN-IGNITION BUZZER	S	S

STANDARD EXTERIOR FEATURES

		CHEYENNE	SILVERADO
FLARES:	FRONT WHEEL OPENING (K3500 ONLY)	S	S
LAMPS:	DAYTIME RUNNING	S	S
SPARE TIRE:	FULL SIZE TIRE & WHEEL, W/WINCH TYPE CARRIER MOUNTED UNDER REAR FRAME	S	S
TOW HOOKS:	TWO FRONT ON 4X4 MODELS	S	S
WIPERS:	INTERMITTENT WINDSHIELD W/PULSE WASHERS	S	S
WIRE HARNESS:	7 LEAD TRAILERING	S	S
WINDOW:	REAR QUARTER SWING-OUT (EXT CAB ONLY)	S	S

STANDARD CHASSIS FEATURES

		CHEYENNE	SILVERADO
BATTERY:	HEAVY-DUTY 600 CCA	S	S
BRAKES:	POWER ASSISTED FRONT DISC, REAR DRUM 4-WHEEL ANTI-LOCK	S	S
ENGINE:	VORTEC 5700 V8 SFI	S	S
EXHAUST SYSTEM:	STAINLESS STEEL	S	S
FUEL TANK:	34 GAL	S	S
GENERATOR:	100 AMP	S	S
<u>STEERING:</u>	<u>SPEED SENSITIVE, POWER (EVO)</u>	S	S
STORAGE BOX:	UNDERHOOD, COVERED	S	S
SUSPENSION FRT:	INDEPENDENT COIL W/2WD INDEPENDENT TORSION BAR W/4X4	S	S
SUSPENSION RR:	MULTI-LEAF SPRINGS	S	S
TRANSMISSION:	5-SPEED MANUAL W/DEEP LOW & OVERDRIVE	S	S

BOLD, ITALICS AND UNDERLINED INDICATES NEW FOR '97

REVISED: 8-19-96

1997 ORDER GUIDE

C/K 3500 PICKUP

Page 1

Prices Shown Are Manufacturer's Suggested Retail Prices (MSRP) At The Time Of Publication. These Prices Are To Be Used Only As An Aid To Inventory Management Since MSRP Figures Change Periodically. The Vehicle Price Schedule Is The Official Pricing Documentation Of Chevrolet Motor Division And Should Be Used In Discussing Vehicle Prices With Potential Buyers. The Model Prices Shown In The Order Guide Include The Destination Freight Charges.

3500 PICKUP TRIM DEFINITION & OPTION SUMMARY

INTERIOR TRIM		CHEYENNE	SILVERADO
AIR CONDITIONING:		--	S
ASSIST HANDLES:	PASSENGER	S	S
CONVENIENCE GP:	POWER WINDOWS AND LOCKS	--	S
	TILT WHEEL AND CRUISE CONTROL	--	S
DOOR TRIM:	MOLDED PLASTIC W/ARMREST	S	--
	COLOR-KEYED CLOTH AND CARPET TRIMMED	--	S
FLOOR COVERING:	COLOR-KEYED CARPET	--	S
	COLOR-KEYED RUBBER	S	--
	RUBBER FLOOR MATS	--	S
HEADLINER:	COLOR-KEYED CLOTH	S	S
INSULATION:	ADDITIONAL SOUND-DEADENING	--	S
MAP POCKETS:	IN PASSENGER AND DRIVER'S DOOR	S	S
RADIO:	AM/FM STEREO W/SEEK-SCAN AND CLOCK	S	--
	AM/FM STEREO W/SEEK-SCAN, CLOCK AND CASSETTE TAPE	--	S
SEATING:	CLOTH BENCH	--	S
	VINYL BENCH (N/A EXT CAB)	S	--
	CLOTH 60/40 SPLIT BENCH (EXT CAB)	--	S
	VINYL 60/40 SPLIT BENCH (EXT CAB)	S	--
STEERING WHEEL:	SIMULATED LEATHER	S	--
	LEATHER WRAPPED	--	S
STORAGE TRAY:	FULL WIDTH BEHIND SEAT	--	S
SUNSHADES:	CLOTH COVERED W/LH STORAGE STRAP, W/RH MIRROR	S	S

EXTERIOR TRIM		CHEYENNE	SILVERADO
BUMPER FRT:	CHROME	S	--
	CHROME W/BLACK RUB STRIP	--	S
BUMPER RR:	CHROME W/STEP PAD	--	S
GRILLE:	MOLDED, PAINTED ARGENT	S	--
	CHROME DELUXE	--	S
HEADLAMPS:	SINGLE RECTANGULAR HALOGEN	S	--
	DUAL COMPOSITE - HALOGEN	--	S
HORN:	SINGLE NOTE	S	--
	DUAL NOTE	--	S
MIRRORS:	BREAK-A-WAY OSRV, BLACK	S	--
	ELECTRIC, REMOTE CONTROL, BLACK	--	S
MOLDINGS:	BODY SIDE WITH BRIGHT TRIM AND BRIGHT WHEEL OPENING TRIM (C3500 & R04)	--	S
NAMEPLATES:	CHEYENNE BADGE ON B-PILLAR	S	--
	SILVERADO BADGE ON B-PILLAR	--	S
PAINT:	SINGLE TONE	S	S
WHEELS:	SILVER PAINTED W/BLACK CENTER CAP	S	--
	RALLY WHEEL TRIM	--	S

BOLD, ITALICS AND UNDERLINED INDICATES NEW FOR '97

MODEL AND BODY
(Reqs R05 Dual or R04 Single Rear Wheels)

Description	Model No	Body	Wheel Base
2-WHEEL-DRIVE MODEL			
Fleetside	CC30903**	E63	131.5
Fleetside, Ext Cab	CC30953	E63	155.5

Description	Model No	Body	Wheel Base
4-WHEEL-DRIVE MODEL			
Fleetside	CK30903**	E63	131.5
Fleetside, Ext Cab	CK30953	E63	155.5

- * Includes Destination & Handling Charges
- ** Reqs R05 Dual or R04 Single Rear Wheels

EMISSIONS (Must Specify One) (Refer Emission Requirements Section)

- FE9 Federal Emission Requirements
- YF5 California Emission Requirements
- NG1 New York/Massachusetts Emission Requirements
- NB8 California or New York/Massachusetts Emission Override (Reqs FE9 Federal Emissions)
- NC7 Federal Emission Override (Reqs YF5 California or NG1 New York/Massachusetts Emissions)

*** GVWR SELECTOR (MUST SPECIFY GVW OPTION)**

Minimum Equipment Required for GVW Rating

GVW Option Required	GVW Rating (lbs)	GAWR*		
		Front	Rear	
C30903				
C6U	9000	3600	6084	Reqs R04 Wheels and YGK or YHH Tires
C7A	10000	3600	7500	Reqs R05 Wheels; N/A KL5 Eng
K30903				
C6W	9200	4250	6084	Reqs R04 Wheels and YGK or YHH Tires
C7A	10000	4250	7500	Reqs R05 Wheels
C30953				
C7A	10000	3600	7500	None
K30953				
C7A	10000	3750	7500	None

*GAWR's shown are the minimum for each axle with equipment listed. Other GAWR's are available, and they are determined as the minimum capacity of either axle, springs or tires.

CAPACITIES

C30903		AXLES:	
SPRINGS:		Front	
Front	3600 Base	3800	Base
Base	3800 w/R05	3800w/R05	
Rear	6084 Base	6084	Base
Base	7500 w/R05	7500	w/R05
C30953		AXLES:	
SPRINGS:		Front	
Front	3600 Base	3800	Base
Rear	7500	7500	Base

K30903		AXLES	
SPRINGS:		Front	
Front	4250 Base	4250	
Rear	6084 Base	6084	
	7500 w/R05	7500	w/R05
K30953		AXLES	
SPRINGS:		Front	
Front	4250 Base	4250	Base
Rear	7500 Base	7500	Base

C/K3500 PICKUP
REFER WEEKLY STOPS/LATEST UPDATE

POWER TEAMS (Must Specify Engine, Transmission and Rear Axle)

(Consult GVWR Selector For Minimum Equipment Required)

	ENGINE	TRANSMISSION	AXLE		GVWR
	5-SP H Duty	AUTO H Duty	4.10	4.56	
CC30903					
L31 Vortec 5700 V8 (350 Cu In)-SFI	MW3	MT1	(a) GT5 GT5	-- --	9000 9000
L31 Vortec 5700 V8 (350 Cu In)-SFI	MW3	MT1	(a) GT5 GT5	-- (a) HC4	10000 10000
L29 Vortec 7400 V8 (454 Cu In)-SFI	MW3	MT1	(a) GT5 GT5	-- --	9000 9000
L29 Vortec 7400 V8 (454 Cu In)-SFI	MW3	MT1	(a) GT5 GT5	(a) HC4 (a) HC4	10000 10000
L65 Turbo Diesel 6.5 Liter V8 H.D. (400 Cu In)	MW3	MT1	GT5	--	9000/10000
CK30903					
L31 Vortec 5700 V8 (350 Cu In)-SFI	MW3	MT1	(a) GT5 GT5	-- --	9200 9200
L31 Vortec 5700 V8 (350 Cu In)-SFI	MW3	MT1	(a) GT5 GT5	-- --	10000 10000
L29 Vortec 7400 V8 (454 Cu In)-SFI	MW3	MT1	(a) GT5 GT5	-- --	9200 9200
L29 Vortec 7400 V8 (454 Cu In)-SFI	MW3	MT1	(a) GT5 GT5	(a) HC4 (a) HC4	10000 10000
L65 Turbo Diesel 6.5 Liter V8 H.D. (400 Cu In)	MW3	MT1	GT5	--	9200/10000
CC30953					
L31 Vortec 5700 V8 (350 Cu In)-SFI	MW3	MT1	(a) GT5 GT5	(a) HC4 (a) HC4	10000 10000
L29 Vortec 7400 V8 (454 Cu In)-SFI	MW3	MT1	(a) GT5 GT5	(a) HC4 HC4	10000 10000
L65 Turbo Diesel 6.5 Liter V8 H.D. (400 Cu In)	MW3	MT1	GT5	--	10000
CK30953					
L31 Vortec 5700 V8 (350 Cu In)-SFI	MW3	MT1	(a) GT5 GT5	-- --	10000 10000
L29 Vortec 7400 V8 (454 Cu In)-SFI	MW3	MT1	(a) GT5 GT5	(a) HC4 (a) HC4	10000 10000
L65 Turbo Diesel 6.5 Liter V8 H.D. (400 Cu In)	MW3	MT1	GT5	--	10000

(a) N/A YF5 California Emissions

TIRES: (Must Specify Front and Rear) (Spare Tire and Tire Carrier Included) (Spare Matches Rear Tire)

Description	Single		On-Off Road		
	Front	Rear	Single Front	Dual Rear	Dual Rear
C30903 - C30953					
TUBELESS Steel Belted Radial					
LT215/85R16-D B/W	** XYK	YYK			
LT225/75R16-D B/W	* XHP	YHP			
LT225/75R16-D B/W	* XHP				YHR
LT245/75R16-E B/W	* XHH	YHH			
LT245/75R16-E B/W	* XHH				YGK
K30903 - K30953					
TUBELESS Steel Belted Radial					
LT215/85R16-D B/W	** XYK	YYK			
(b)LT215/85R16-D B/W			XYL		YYL
LT225/75R16-D B/W			XHR		YHR
LT225/75R16-D B/W	* XHP	YHP			
(a)LT245/75R16-E B/W	* XHH	YHH			
(a)LT245/75R16-E B/W			XGK		YGK

- * All Seasons
- ** Highway
- (a) N/A K30953
- (b) Reqs F60 Front Springs

B/W = Blackwall

C/K 3500 PICKUP

MUST SPECIFY:

AXLE, EMISSION, ENGINE, TIRES AND TRANSMISSION

**Additional Upgrades, Deletions (Where Indicated)
Options may be Ordered from the Custom Ordering Option Listing.**

	Reg & Ext Decor		
	CHEYENNE	SILVERADO	
	1 S A	1 S B	1 S C
CHEYENNE DECOR	x	--	--
Fleetside Body Code E63	x	x	x
SILVERADO DECOR		x	x
Extended Cab			
Regular Cab			
SILVERADO DECOR (Leather)			
Extended Cab			
Regular Cab			
Keyless Entry			x
Mirror, ISRV			x
Seat, Power (A)			x
Trim, Leather (B)			x

(A) Extended Cab Only
(B) Must Specify Trim Color: May Upgrade to A95 Seat on Extended Cab

Preferred Equipment Group Prices

N.C. 1SA
PEG Savings
 **(-700.00) w/R9A & R9C
 **(-500.00) w/R9A
 **(-200.00) w/R9B or R9C
 N.C. w/o R9A, R9B or R9C

Preferred Equipment Group Prices

**(-750.00) 1SB or 1SC

* PEG Savings Amount represents the savings for Preferred Equipment Groups.

REGULAR CAB MARKETING PACKAGES

CONVENIENCE PACKAGE
ORDERING OPTION=R9A

(Reqs Peg 1SA)

Incls :

C60 Air Conditioning
UM6 Radio w/Cassette
ZQ3 Tilt and Cruise

BRIGHT APPEARANCE PACKAGE

w/R05

2-Wheel Drive w/R04

4-Wheel Drive w/R04

ORDERING OPTION=R9B

(Reqs Peg 1SA)

Incls :

B85 Body Side Moldings (w/o Dual Rear Wheels)
V22 Chrome Grille
VB3 Chrome Rear Step Bumper
VG3 Chromed Front Bumper
P06 Rally Wheels

COMMERCIAL OPTION PACKAGE

2-Wheel Drive

4-Wheel Drive w/Diesel Eng

4-Wheel Drive w/Gas Eng

ORDERING OPTION=R9C

(Reqs Peg 1SA) (N/A R9B Bright Appearance Pkg)

Incls :

BZY Bedliner
E63 Fleetside
V43 Painted Step Bumper
F60 HD Front Springs (K Models Only)
V76 Tow Hooks (C Models Only)
NZZ Skid Plate (K Models Only)
A28 Sliding Rear Window

EXTENDED CAB MARKETING PACKAGES

CONVENIENCE PACKAGE

ORDERING OPTION=R9A

(Reqs Peg 1SA)

Incls :

C60 Air Conditioning
UM6 Radio w/Cassette
ZQ3 Tilt and Cruise

BRIGHT APPEARANCE PACKAGE

w/R05

4-Wheel Drive w/R04

2-Wheel Drive w/R04

ORDERING OPTION=R9B

(Reqs Peg 1SA)

Incls :

V22 Chrome Grille
VB3 Chrome Rear Step Bumper
VG3 Chromed Front Bumper
P06 Rally Wheels

COMMERCIAL OPTION PACKAGE

2-Wheel Drive

4-Wheel Drive w/Diesel Eng

4-Wheel Drive w/Gas Eng

ORDERING OPTION=R9C

(Reqs Peg 1SA) (N/A R9B Bright Appearance Pkg)

Incls :

BZY Bedliner
E63 Fleetside
V43 Painted Step Bumper
F60 HD Front Springs (K Models Only)
V76 Tow Hooks (C Models Only)
NZZ Skid Plate (K Models Only)
A28 Sliding Rear Window

**C/K3500 PICKUP
REFER WEEKLY STOPS/LATEST UPDATE**

ADDITIONAL OPTIONS

INCL W/DECOR		OPTION
CHEY- ENNE	SILVER- ADO	
		ACKNOWLEDGEMENTS
		R8S Multiple Order Numbers
		R8T Preliminary Invoice (Refer Vehicle Price Schedule for Prices)
		K47 AIR CLEANER: High Capacity
		AIR CONDITIONING: (One Of The Following Options Must Be Ordered w/PEG 1SA w/o Convenience Pkg R9A)
		YG6 Air Conditioning Not Desired
	x	C60 Air Conditioning: (Incls R134A Refrigerant) w/1SB or 1SC or R9A w/1SA
	x	V22 APPEARANCE PACKAGE: (Incls Chrome Grille, Composite Halogen Headlamps and Dual Horns) w/1SB, 1SC or R9B w/1SA
		AXLES, REAR: (Refer Power Teams Chart for Availability)
		GT5 4.10 Ratio
		HC4 4.56 Ratio (Incls G80 Locking Differential)
		G80 Locking Differential (Included w/HC4 Axle) w/HC4 w/o HC4
		TP2 BATTERY: Heavy-Duty, Auxiliary (N/A Diesel Eng) (Deletes Underhood Storage Box)
		BZY BEDLINER: Under Rail w/R9C w/o R9C
		E63 BODY CODE: Fleetside Body
		BUMPER EQUIPMENT: (Vehicles registered in certain states, must have a rear bumper to be operated on their roads. Consult your local laws.) (Cheyenne Decor does not include a Rear Bumper)
N/A		EF1 Bumper Delete Provisions
	x	V83 Bumper, Chromed. Rear Step w/Rub Strip (Reqs VG3 Bumper or Silverado Decor) w/1SB, 1SC or R9B w/1SA
	x	VG3 Bumper, Chromed. Front Deluxe w/Rub Strips w/1SB, 1SC or R9B w/1SA
	N/A	V43 Bumper, Painted. Rear Step w/R9C w/o R9C
	x	V10 COLD-CLIMATE PACKAGE: (Incls Eng Block Heater) (Diesel Eng Reqs Base Decor and Reg Cab)
		ZQ3 CONVENIENCE GROUP: Tilt-Wheel and Speed Control w/1SB, 1SC or R9A w/1SA
N/A		C49 DEFOGGER: Rear Window, Electric (N/A A28 Window or C-K30903)
		EMISSIONS: (Refer Emission Requirement Tab Section)
		FE9 Federal Emission Requirements
		YF5 California Emission Requirements
		NG1 New York/Massachusetts State Emission Requirements
		NB8 California or New York/Massachusetts State Emission Override (Reqs FE9 Federal Emissions)
		NC7 Federal Emission Override (Reqs YF5 California or NG1 New York/Massachusetts State Emissions)
		ENGINES: (Refer Power Teams Chart for Availability)
		L31 Vortec 5700 V8 (350 Cu In)-SFI
		L29 Vortec 7400 V8 (454 Cu In)-SFI
		L65 6.5 Liter V8 Turbo Diesel (400 Cu In) (Incls Bumper Guards w/Silverado Decor) (Deletes Underhood Storage Box)
		KL5 Alternative Fuel (LPG & CNG Conversion Ready) (Reqs L31 Eng and MT1 Trans) (C-K30903 N/A R05 Dual Rear Wheels)
		FLOOR COVERING:
		BG9 Full Floor, Rubber, Color-Keyed (Replaces Carpeting and Floor Mats) w/CK10*03 w/CK10*53
	N/A	B30 Carpet Floor Covering w/CK10*03 w/CK10*53
	x	B32 Floor Mats (Reqs B30 Floor Covering)
	x	B33 Floor Mats (N/A YG4 Seat Delete) (Reqs B30 Carpet, B32 Floor Mats and C-K***53)
		AJ1 GLASS: Deep Tinted Solar-Ray (With C49 Defogger, Rear Window is Light Tint Glass) (C-K30903 Reqs A28 Sliding Rear Window) w/C49 w/o C49
		GVWR: (Must Specify One) (Refer GVWR Selector Chart for Availability)
		C6U 9000#
		C6W 9200#
		C7A 10000#
N/A		AU0 KEYLESS ENTRY: (Reqs Silverado Decor) w/1SC w/o 1SC

ADDITIONAL OPTIONS

INCL W/DECOR		OPTION
CHEV- ENNE	SILVER- ADD	
		LD1 LAMPS: Roof (Standard on C-K30953) (N/A YF5 Calif Emissions w/R04 Rear Wheels) (Incl w/R05 Dual Rear Wheels) w/R05 w/R04
	N/A	VK3 LICENSE PLATE BRACKET: Front
		AU3 LOCKS: Power door
		MIRRORS:
		DF2 Camper Type, Stainless Steel, 7.5" W x 10.5" H, Exterior w/1SB or 1SC w/1SA
	N/A	DD7 10" Electrochromic ISRV with 8 Point Compass, Interior w/1SC w/1SB
		B85 MOLDING: Exterior, Bright (Incl w/Silverado Decor w/o R05 Dual Rear or w/o K30953) (N/A R05 Dual Rear Wheels or K30953) (C30903 Incls Body Side and Wheel Opening Moldings) (K30903 Incls Body Side Molding Only) w/1SB, 1SC or R9B w/K30903 w/C309*3
		PAINT, EXTERIOR: (Refer Color/Trim Chart for Availability)
	N/A	ZY1 Solid
	N/A	ZY2 Conventional Two-Tone
		ZY4 Deluxe Two-Tone
		RADIO EQUIPMENT:
	x	UM6 Electronically Tuned AM/FM Stereo Radio w/Seek-Scan, Digital Clock and Cassette Tape w/1SB, 1SC or R9A w/1SA
	N/A	ULO Electronically Tuned AM/FM Stereo Radio w/Seek-Scan, Digital Clock, Automatic Tone Control, Cassette Tape, Theft Lock and Speed Compensated Volume (Incls an Enhanced Performance Speaker System)
	N/A	UND Electronically Tuned AM/FM Stereo Radio w/Seek-Scan, Digital Clock, Automatic Tone Control, Compact Disc Player, Theft Lock and Speed Compensated Volume (w/Silverado Decor Incls an Enhanced Performance Speaker System)
	N/A	UPO Electronically Tuned AM/FM Stereo Radio w/Seek-Scan, Digital Clock, Automatic Tone Control, Stereo Cassette Tape w/Search and Repeat, Compact Disc Player, Theft Lock and Speed Compensated Volume (w/Silverado Decor Incls an Enhanced Performance Speaker System) (Reqs M30 or MT 1 Trans)
	N/A	UL5 Radio Delete
	N/A	AG9 SEAT: Power Driver's Seat (Reqs AE7 Custom Cloth Split Bench or A95 Bucket Seats) (N/A C-K 30903) (N/A Vinyl Trim) w/1SC w/o 1SC
		SEAT TYPE: (Refer Color/Trim Chart for Availability)
		A52 Bench Seat (Incls Storage Armrest and Power Lumbar w/Custom Cloth or Leather Trim) w/1SA or 1SB w/o Leather w/1SB and Leather
		AE7 Reclining Split Bench Seat (Incls Storage Armrest and Power Lumbar w/Custom Cloth or Leather Trim) w/1SC Extended Cab w/1SA or 1SB w/o Leather w/1SB and Leather Regular Cab w/1SA or 1SB w/o Leather w/1SB and Leather
		A95 Reclining High Back Bucket Seats (Incls Power Lumbar and Floor Console; Also Includes Overhead Console on Extended Cab) Extended Cab w/1SC w/1SB and Cloth w/1SB and Leather Regular Cab w/1SB and Cloth w/1SB and Leather
	N/A	YG4 SEAT DELETE, REAR: (N/A C-K30903)
		NZZ SKID PLATE: Off-Road (K3500 Only) (Incls Engine Front Differential and Transfer Case Shield) w/R9C w/o R9C
		VYU SNOW PLOW PREP PACKAGE: (K30903 Only) (Incls F60 HD Front Springs) w/R9C w/o R9C

C/K3500 PICKUP

INCL W/DECOR		OPTION
CHEV- ENNE	SILVER- ADO	
		F60 SPRINGS, FRONT: Heavy Duty (K3500 Only) (Incl w/VYU Snow Plow) w/VYU or R9C w/o VYU or R9C
		TIRES: (Refer Tire Chart for Availability; Vehicle Price Schedule for Prices)
		V76 TOW HOOKS: (Standard on K3500 Models) w/R9C w/o R9C
		Z82 TRAILERING SPECIAL EQUIPMENT: Heavy-Duty (Reqs VB3 or V43 Bumper) (Incls Trailer Hitch Platform and Wiring Harness)
		TRANSMISSIONS: (Refer Power Teams Chart for Availability)
		MW3 5-Speed Manual with Deep Low and Overdrive, Heavy-Duty
		MT1 4-Speed Electronically Controlled Automatic with Overdrive, Heavy-Duty (Incls HD Auxiliary Trans Cooler)
	x	P06 WHEEL TRIM: Rally Wheel Trim w/1SB, 1SC or R9B w/1SA
		WHEELS, REAR: Note - One of the Following Wheel Options Must Be Specified on C-K 30903 models
		R04 Single Rear (Reqs YHH or YGK Tires) (N/A C-K30953)
		R05 Dual Rear (Standard on C-K 30953 models) (Incls U01 Roof Marker Lamps and Tailgate Lamps) C-K30953 C-K30903
		A28 WINDOWS: Sliding Rear (N/A C49 Defogger) w/R9C w/o R9C

**C/K 3500 PICKUP
PAINT APPLICATIONS
WITH ZY1, ZY2 AND ZY4 PAINT SCHEMES**

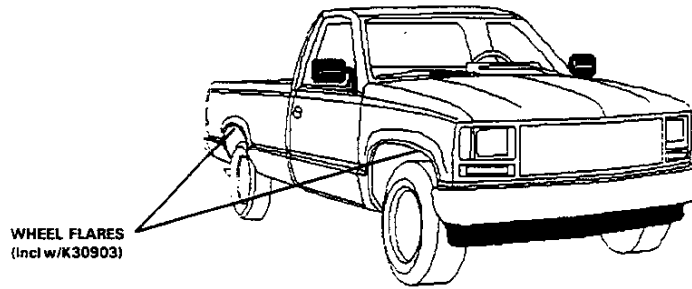

SOLID PAINT - ZY1

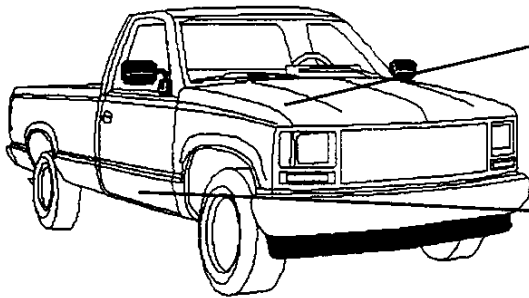

CONVENTIONAL TWO-TONE PAINT - ZY2 w/C30903

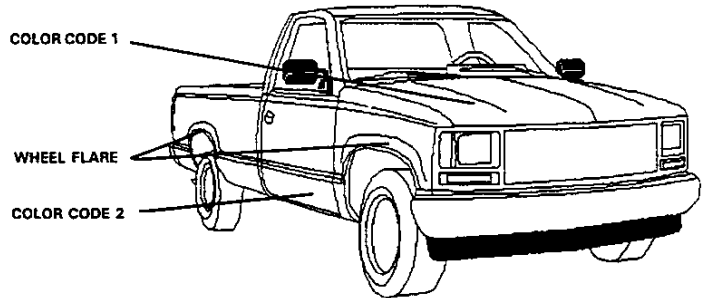

CONVENTIONAL TWO-TONE PAINT - ZY2 w/K30903

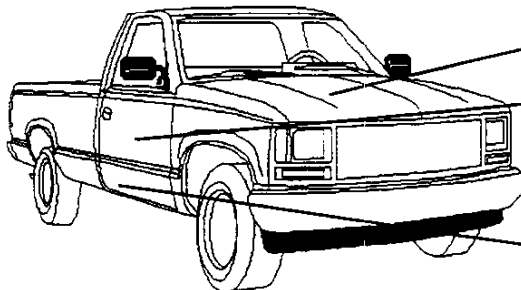

DELUXE TWO-TONE PAINT - ZY4 w/C30903
(Includes Body Striping)

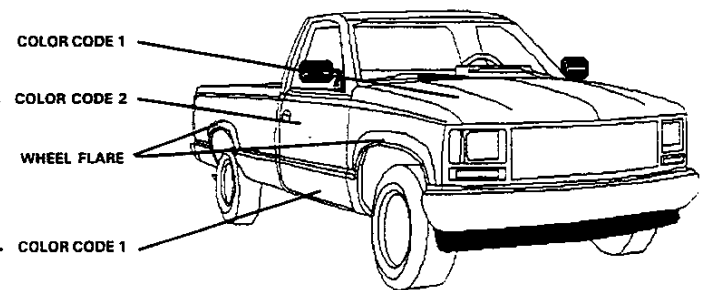

DELUXE TWO-TONE PAINT - ZY4 w/K30903
(Includes Body Striping)

C/K 3500 PICKUP INTERIOR AND EXTERIOR COLOR AVAILABILITY CHART WITH ZY1 PAINT SCHEMES

PLEASE NOTE: Below are the interior trim color and exterior paint combinations recommended by Chevrolet. They are the only available interior and exterior combinations allowed.

TRIM LEVEL (Must Specify Seat Option and Interior Color) Seat Type	SEAT OPT	INTERIOR COLORS			
		Neutral	Blue	Gray	Red
CHEYENNE/X81 WORK TRUCK PKG (STD DECOR)					
REGULAR CAB					
Vinyl Bench Seat	A52	52V	26V	13V	79V
Cloth Bench Seat	A52	52C	26C	13C	79C
EXTENDED CAB					
Vinyl Reclining Split Bench Seat	AE7	52V	26V	13V	79V
Cloth Reclining Split Bench Seat	AE7	52C	26C	13C	79C
SILVERADO DECOR					
REGULAR CAB					
Vinyl Bench Seat	A52	52V	26V	13V	79V
Custom Cloth Bench Seat	A52	52D	26D	13D	79D
* Custom Leather Bench Seat	A52	522	262	132	792
Custom Cloth Reclining Split Bench Seat	AE7	52D	26D	13D	79D
* Custom Leather Reclining Split Bench Seat	AE7	522	262	132	792
Custom Cloth Reclining High Back Bkt Seats	A95	52D	26D	13D	79D
EXTENDED CAB					
Vinyl Reclining Split Bench Seat	AE7	52V	26V	13V	79V
Custom Cloth Reclining Split Bench Seat	AE7	52D	26D	13D	79D
* Custom Leather Reclining Split Bench Seat	AE7	522	262	132	792
Custom Cloth Reclining High Back Bkt Seats	A95	52D	26D	13D	79D
* Custom Leather Reclining High Back Bkt Seats	A95	522	262	132	792

EXTERIOR COLORS	Color Code	PAINT SCHEME	INTERIOR & EXTERIOR COMBINATIONS SHOWN ARE THE ONLY COMBINATIONS AVAILABLE				Wheel Flare Colors Avail or Std on (a) 4-WD 8600 GVWR
^ AUTUMNWOOD, LT (Metallic)	55U	ZY1	x				Autumnwood, Lt
BLACK, ONYX	41U	ZY1	x		x	x	Black, Onyx
^ BLUE, GREEN MED (Metallic)	35U	ZY1	x		x		Dk Argent
BLUE, LT (Metallic)	27U	ZY1		x	x		Dk Argent
BLUE, ROYAL MED (Metallic)	25U	ZY1	x	x	x		Blue, Royal Med
GREEN, EMERALD (Metallic)	43U	ZY1	x		x		Dk Argent
QUICKSILVER (Metallic)	96U	ZY1		x	x	x	Quicksilver
RED, CARMINE DK (Metallic)	51U	ZY1	x		x	x	Red, Carmine Dk
RED, VICTORY	74U	ZY1	x		x	x	Dk Argent
WHITE, SUMMIT	50U	ZY1	x	x	x	x	Dk Argent

- * Leather on Seating Surface Only
- (a) Incl on Front Only w/Dual Rear Wheels

C/K 3500 PICKUP INTERIOR AND EXTERIOR COLOR AVAILABILITY CHART ZY2 PAINT SCHEMES

PLEASE NOTE: Below are the interior trim color and exterior paint combinations recommended by Chevrolet. They are the only available interior and exterior combinations allowed.

TRIM LEVEL (Must Specify Seat Option and Interior Color) Seat Type	SEAT OPT	INTERIOR COLORS			
		Neutral	Blue	Gray	Red
SILVERADO DECOR					
REGULAR CAB					
Vinyl Bench Seat	A52	52V	26V	13V	79V
Custom Cloth Bench Seat	A52	52D	26D	13D	79D
Custom Leather Bench Seat	A52	522	262	132	792
Custom Cloth Reclining Split Bench Seat	AE7	52D	26D	13D	79D
Custom Leather Reclining Split Bench Seat	AE7	522	262	132	792
Custom Cloth Reclining High Back Bkt Seats	A95	52D	26D	13D	79D
EXTENDED CAB					
Vinyl Reclining Split Bench Seat	AE7	52V	26V	13V	79V
Custom Cloth Reclining Split Bench Seat	AE7	52D	26D	13D	79D
Custom Leather Reclining Split Bench Seat	AE7	522	262	132	792
Custom Cloth Reclining High Back Bkt Seats	A95	52D	26D	13D	79D
Custom Leather Reclining High Back Bkt Seats	A95	522	262	132	792

EXTERIOR COLORS	Color Code 1	Color Code 2	PAINT SCHEME	INTERIOR & EXTERIOR COMBINATIONS SHOWN ARE THE ONLY COMBINATIONS AVAILABLE				Wheel Flare Colors Avail or Std on (a) 4-WD
Autumnwood, Lt (Met)/Red, Carmine Dk (Met)	55U	51L	ZY2	x			x	Red, Carmine Dk
Black, Onyx/Autumnwood, Lt (Met)	41U	55L	ZY2	x				Autumnwood, Lt
Black, Onyx/Quicksilver (Met)	41U	96L	ZY2			x	x	Quicksilver
+ Black, Onyx/Red Victory (Met)	41U	74L	ZY2	x		x	x	N/A
Blue, Green Med (Met)/Autumnwood, Lt (Met)	35U	55L	ZY2	x				Autumnwood, Lt
Blue, Green Med (Met)/Quicksilver (Met)	35U	96L	ZY2			x		Quicksilver
Blue, Lt (Met)/Quicksilver (Met)	27U	96L	ZY2		x	x		Quicksilver
Blue, Royal Med (Met)/Autumnwood, Lt (Met)	25U	55L	ZY2	x	x			Autumnwood, Lt
Blue, Royal Med (Met)/Quicksilver (Met)	25U	96L	ZY2		x	x		Quicksilver
Green, Emerald (Met)/Autumnwood, Lt (Met)	43U	55L	ZY2	x				Autumnwood, Lt
Green, Emerald (Met)/Quicksilver (Met)	43U	96L	ZY2			x		Quicksilver
Quicksilver (Met)/Black, Onyx	96U	41L	ZY2			x	x	Black, Onyx
+ Quicksilver (Met)/Blue, Lt (Met)	96U	27L	ZY2		x	x		N/A
Quicksilver (Met)/Blue, Royal Med (Met)	96U	25L	ZY2		x	x		Blue, Royal Med
+ Quicksilver (Met)/Green, Emerald (Met)	96U	43L	ZY2			x		N/A
Quicksilver (Met)/Red, Carmine Dk (Met)	96U	51L	ZY2			x	x	Red, Carmine Dk
- Quicksilver (Met)/Red, Victory (Met)	96U	74L	ZY2			x		N/A
Red, Carmine Dk (Met)/Autumnwood, Lt (Met)	51U	55L	ZY2	x			x	Autumnwood, Lt
Red, Carmine Dk (Met)/Quicksilver (Met)	51U	96L	ZY2			x	x	Quicksilver
Red, Victory/Autumnwood, Lt (Met)	74U	55L	ZY2	x				Autumnwood, Lt
Red, Victory/Black, Onyx	74U	41L	ZY2	x		x	x	Black, Onyx
Red, Victory/Quicksilver (Met)	74U	96L	ZY2			x		Quicksilver
White, Summit/Autumnwood, Lt (Met)	50U	55L	ZY2	x				Autumnwood, Lt
- White, Summit/Blue, Lt (Met)	50U	27L	ZY2		x	x		N/A
White, Summit/Blue, Royal Med (Met)	50U	25L	ZY2		x	x		Blue, Royal Med
White, Summit/Red, Carmine Dk (Met)	50U	51L	ZY2				x	Red, Carmine Dk

- * Leather on Seating Surface Only
- N/A K3500
- (a) Incl on Front only w/Dual Rear Wheels

REVISED: 12-16-96

1997 ORDER GUIDE

C/K 3500 PICKUP

^ Indicates Change

Page 13

Prices Shown Are Manufacturer's Suggested Retail Prices (MSRP) At The Time Of Publication. These Prices Are To Be Used Only As An Aid To Inventory Management Since MSRP Figures Change Periodically. The Vehicle Price Schedule Is The Official Pricing Documentation Of Chevrolet Motor Division And Should Be Used In Discussing Vehicle Prices With Potential Buyers. The Model Prices Shown In The Order Guide Include The Destination Freight Charges.

C/K 3500 PICKUP INTERIOR AND EXTERIOR COLOR AVAILABILITY CHART ZY4 PAINT SCHEMES

PLEASE NOTE: Ed. 2W are the interior trim color and exterior paint combinations recommended by Chevrolet. They are the only available interior and exterior combinations allowed.

TRIM LEVEL (Must Specify Seat Option and Interior Color) Seat Type	SEAT OPT	INTERIOR COLORS			
		Neutral	Blue	Gray	Red
SILVERADO DECOR					
REGULAR CAB					
Onyx Bench Seat	A52	52V	26V	13V	79V
Custom Cloth Bench Seat	A52	52D	26D	13D	79D
* Custom Leather Bench Seat	A52	522	262	132	792
Custom Cloth Reclining Split Bench Seat	AE7	52D	26D	13D	79D
* Custom Leather Reclining Split Bench Seat	AE7	522	262	132	792
Custom Cloth Reclining High Back Bkt Seats	A95	52D	26D	13D	79D
EXTENDED CAB					
Onyx Reclining Split Bench Seat	AE7	52V	26V	13V	79V
Custom Cloth Reclining Split Bench Seat	AE7	52D	26D	13D	79D
* Custom Leather Reclining Split Bench Seat	AE7	522	262	132	792
Custom Cloth Reclining High Back Bkt Seats	A95	52D	26D	13D	79D
* Custom Leather Reclining High Back Bkt Seats	A95	522	262	132	792

EXTERIOR COLORS	Color Code 1	Color Code 2	PAINT SCHEME	INTERIOR & EXTERIOR COMBINATIONS SHOWN ARE THE ONLY COMBINATIONS AVAILABLE				STRIPE COLORS Top-Lower/Center
Autumnwood, Lt (Met)/Blue, Green Med (Met)	55U	35L	ZY4	x				Beige/Autumnwood
Autumnwood, Lt (Met)/Green, Emerald (Met)	55U	43L	ZY4	x				Beige/Autumnwood
Autumnwood, Lt (Met)/Red, Carmine Dk (Met)	55U	51L	ZY4	x			x	Beige/Autumnwood
Autumnwood, Lt (Met)/Red, Victory (Met)	55U	74L	ZY4	x				Beige/Black
Black, Onyx/Autumnwood, Lt (Met)	41U	55L	ZY4	x				Beige/Black
Black, Onyx/Quicksilver (Met)	41U	96L	ZY4			x		Gunmetal/Silver
* Black, Onyx/Red, Victory (Met)	41U	74L	ZY4	x				Beige/Black
* Black, Onyx/Red, Victory (Met)	41U	74L	ZY4			x	x	Gunmetal/Silver
Blue, Green Med (Met)/Autumnwood, Lt (Met)	35U	55L	ZY4	x				Beige/Autumnwood
+ Blue, Green Med (Met)/Quicksilver (Met)	35U	96L	ZY4			x		Green/Silver
+ Blue, Lt (Met)/Quicksilver (Met)	27U	96L	ZY4		x	x		Lt Indigo/Dk Indigo
Blue, Royal Med (Met)/Autumnwood, Lt (Met)	25U	55L	ZY4	x				Beige/Black
Blue, Royal Med (Met)/Quicksilver (Met)	25U	96L	ZY4		x	x		Gunmetal/Silver
+ Green, Emerald (Met)/Quicksilver (Met)	43U	96L	ZY4			x		Green/Silver
+ Green, Emerald (Met)/Autumnwood, Lt (Met)	43U	55L	ZY4	x				Beige/Black
Quicksilver (Met)/Black, Onyx	96U	41L	ZY4			x	x	Gunmetal/Silver
Quicksilver (Met)/Blue, Lt (Met)	96U	27L	ZY4		x	x		Dk Indigo/Lt Indigo
Quicksilver (Met)/Blue, Green Med (Met)	96U	35L	ZY4			x		Green/Silver
Quicksilver (Met)/Blue, Royal Med (Met)	96U	25L	ZY4		x	x		Gunmetal/Silver
Quicksilver (Met)/Green, Emerald (Met)	96U	43L	ZY4			x		Gunmetal/Silver
Quicksilver (Met)/Red, Carmine Dk (Met)	96U	51L	ZY4			x	x	Gunmetal/Silver
* Red, Carmine Dk (Met)/Autumnwood, Lt (Met)	51U	55L	ZY4	x				Beige/Autumnwood
* Red, Carmine Dk (Met)/Autumnwood, Lt (Met)	51U	55L	ZY4				x	Beige/Silver
Red, Carmine Dk (Met)/Quicksilver (Met)	51U	96L	ZY4			x	x	Gunmetal/Silver
* Red, Victory/Autumnwood, Lt (Met)	74U	55L	ZY4	x				Beige/Black
+ Red, Victory/Black, Onyx	74U	41L	ZY4			x		Beige/Black
+ Red, Victory/Quicksilver (Met)	74U	96L	ZY4			x	x	Gunmetal/Silver
* Red, Victory/White, Summit	74U	50L	ZY4			x	x	Gunmetal/Silver
* Red, Victory/White, Summit	74U	50L	ZY4	x				Beige/Black

* Leather on Seating Surface Only
+ N/A K3500

Wheel Flare Colors Using Color Code 1	
Available or Std on (a) 4-WD	
25U	Blue, Royal Med
27U	N/A
35U	N/A
41U	Black, Onyx
43U	N/A
51U	Red, Carmine Dk
55U	Autumnwood, Lt
74U	N/A
96U	Quicksilver

C/K 3500 PICKUP

1997 ORDER GUIDE

REVISED: 12-16-96

Page 14

^ Indicates Change

Prices Shown Are Manufacturer's Suggested Retail Prices (MSRP) At The Time Of Publication. These Prices Are To Be Used Only As An Aid To Inventory Management Since MSRP Figures Change Periodically. The Vehicle Price Schedule Is The Official Pricing Documentation Of Chevrolet Motor Division And Should Be Used In Discussing Vehicle Prices With Potential Buyers. The Model Prices Shown In The Order Guide Include The Destination Freight Charges.

1997 NEW PRODUCT HIGHLIGHTS

CK CREW CABS

SPEED SENSITIVE POWER STEERING

ZY2 CONVENTIONAL TWO-TONE PAINT

ZY4 DELUXE TWO-TONE PAINT

DEALERS WILL BE REQUIRED TO ORDER OPTION YG6 (AIR CONDITIONING NOT DESIRED) IF AIR CONDITIONING IS NOT ORDERED OR IS NOT STANDARD.

THREE NEW COLORS. GREEN BLUE METALLIC, ROYAL BLUE METALLIC AND DARK CARMINE RED METALLIC.



3500 CREW CAB PICKUP EQUIPMENT SUMMARY

STANDARD INTERIOR FEATURES		CHEYENNE	SILVERADO
CUPHOLDERS:	DUAL IN DASH	S	S
DOOR BEAMS:	SIDE IMPACT	S	S
GAUGES:	TRIP ODOMETER, OIL PRESSURE, VOLTMETER AND TACHOMETER	S	S
GLASS:	SOLAR RAY TINTED, ALL WINDOWS	S	S
HEATING DUCT:	REAR SEAT	S	S
JACK:	WITH WHEEL WRENCH	S	S
INSULATION:	UNDER DASH & FLOOR COVERING	S	S
LIGHTING:	DOME W/LH & RH DOOR SWITCHW/DELAYED ENTRY FEATURE, READING, ASHTRAY, GLOVE-BOX, UNDERHOOD & CARGO LAMPS. REAR DOOR LIGHT SWITCH	S	S
POWER POINTS:	DUAL COVERED	S	S
SCOTCHGARD:	ALL CLOTH AND CARPET SURFACES	S	S
SEAT BELTS:	ADJUSTABLE HEIGHT, FRONT	S	S
WARNING TONE:	KEY-IN-IGNITION BUZZER	S	S

STANDARD EXTERIOR FEATURES		CHEYENNE	SILVERADO
FLARES:	FRONT AND REAR (K3500 ONLY)	S	S
LAMPS:	DAYTIME RUNNING	S	S
SPARE TIRE:	FULL SIZE TIRE & WHEEL, W/WINCH TYPE CARRIER MOUNTED UNDER REAR FRAME	S	S
TAILGATE:	REMOVABLE	S	S
TOW HOOKS:	TWO FRONT ON 4X4 MODELS	S	S
WIPERS:	INTERMITTENT WINDSHIELD W/PULSE WASHERS	S	S
WIRE HARNESS:	7 LEAD TRAILERING	S	S

STANDARD CHASSIS FEATURES		CHEYENNE	SILVERADO
BATTERY:	HEAVY-DUTY 600 CCA	S	S
BRAKES:	POWER ASSISTED FRONT DISC, REAR DRUM 4-WHEEL ANTI-LOCK	S	S
ENGINE:	VORTEC 5700 V8 SFI	S	S
EXHAUST SYSTEM:	STAINLESS STEEL	S	S
FUEL TANK:	34 GAL	S	S
GENERATOR:	100 AMP	S	S
<u>STEERING:</u>	<u>SPEED SENSITIVE POWER (EVO)</u>	S	S
STORAGE BOX:	UNDERHOOD, COVERED	S	S
SUSPENSION FRT:	INDEPENDENT COIL W/2WD INDEPENDENT TORSION BAR W/4X4	S	S
SUSPENSION RR:	MULTI-LEAF SPRINGS	S	S
TRANSMISSION:	5-SPEED MANUAL W/DEEP LOW & OVERDRIVE	S	S

BOLD, ITALICS AND UNDERLINED INDICATES NEW FOR '97

REVISED: 8-19-96

1997 ORDER GUIDE

C/K CREW CAB PICKUP

Page 1

Prices Shown Are Manufacturer's Suggested Retail Prices (MSRP) At The Time Of Publication. These Prices Are To Be Used Only As An Aid To Inventory Management Since MSRP Figures Change Periodically. The Vehicle Price Schedule Is The Official Pricing Documentation Of Chevrolet Motor Division And Should Be Used In Discussing Vehicle Prices With Potential Buyers. The Model Prices Shown In The Order Guide Include The Destination Freight Charges.

3500 CREW CAB PICKUP TRIM DEFINITION & OPTION SUMMARY

INTERIOR TRIM

	CHEYENNE	SILVERADO
AIR CONDITIONING:	--	S
ASSIST HANDLES: PASSENGER	S	S
CONVENIENCE GP: CRUISE CONTROL AND TILT WHEEL	--	S
POWER WINDOWS, LOCKS	--	S
DOOR TRIM: MOLDED PLASTIC W/ARMREST	S	--
COLOR-KEYED CLOTH AND CARPET TRIM	--	S
FLOOR COVERING: COLOR-KEYED CARPET, W/MATS	--	S
BLACK RUBBER	S	--
HEADLINER: COLOR-KEYED CLOTH	S	S
INSULATION: ADDITIONAL SOUND-DEADENING	--	S
MAP POCKETS: IN PASSENGER AND DRIVER'S DOOR	S	S
MIRROR: 10" ELECTROCHROMIC ISRV WITH 8 POINT COMPASS	--	S
RADIO: AM/FM STEREO W/SEEK-SCAN AND CLOCK	S	--
AM/FM STEREO W/SEEK-SCAN, CLOCK AND CASSETTE TAPE	--	S
SEATING: VINYL BENCH	S	S
STEERING WHEEL: SIMULATED LEATHER	S	--
LEATHER WRAPPED	--	S
SUNSHADES: CLOTH COVERED W/LH STORAGE STRAP & RH MIRROR	S	--
LH STORAGE STRAP AND LH/RH LIGHTED MIRRORS AND EXTENDERS	--	S

EXTERIOR TRIM

	CHEYENNE	SILVERADO
BUMPER FRT: CHROME	S	--
CHROME W/BLACK RUB STRIP	--	S
BUMPER RR: CHROME W/STEP PAD	--	S
GRILLE: MOLDED, PAINTED ARGENT	S	--
CHROME DELUXE	--	S
HEADLAMPS: SINGLE RECTANGULAR HALOGEN	S	--
DUAL COMPOSITE - HALOGEN	--	S
HORN: SINGLE NOTE	S	--
DUAL NOTE	--	S
MIRRORS: BREAK-A-WAY OSRV, BLACK	S	--
ELECTRIC, REMOTE CONTROL: BLACK	--	S
NAMEPLATES: CHEYENNE BADGE ON B-PILLAR	S	--
SILVERADO BADGE ON B-PILLAR	--	S
PAINT: SINGLE TONE	S	S
WHEELS: SILVER PAINTED W/BLACK CENTER CAP	S	--
RALLY WHEEL TRIM	--	S

BOLD, ITALICS AND UNDERLINED INDICATES NEW FOR '97

C/K 3500 CREW CAB PICKUP

MODEL AND BODY

(Reqs R05 Dual or R04 Single Rear Wheels)

Description	Model No	Body	Wheel Base
2-WHEEL DRIVE MODEL Fleetside	CC30943	E63	168.5

Description	Model No	Body	Wheel Base
4-WHEEL DRIVE MODEL Fleetside	CK30943	E63	168.5

*Includes Destination & Handling Charges

*GVWR SELECTOR (MUST SPECIFY GVW OPTION)

GVW Option Required	GVW Rating (lbs)	Minimum Equipment Required For GVW Rating		
		*GAWR Front	*GAWR Rear	
	C30943			
C6U	9000	4100	6084	N/A R05 Wheels
C7A	10000	4100	7500	Reqs R05 Wheels
	K30943			
C6W	9200	4500	6084	N/A R05 Wheels
C7A	10000	4500	7500	Reqs R05 Wheels

*GAWR's shown are the minimum for each axle with equipment listed.

CAPACITIES

C30943			
SPRINGS:		AXLES:	
Front		Front	
4100	Base	4100	Base
Rear		Rear	
6084	Base	6084	Base
7500	w/R05	7500	w/R05

K30943			
SPRINGS:		AXLES:	
Front		Front	
4500	Base	4500	Base
Rear		Rear	
6084	Base	6084	Base
7500	w/R05	7500	w/R05

C/K 3500 CREW CAB PICKUP

EMISSIONS (Must Specify One) (Refer Emission Requirements Section)

- FE9 Federal Emission Requirements
- YF5 California Emission Requirements
- NG1 New York/Massachusetts Emission Requirements
- NB8 California or New York/Massachusetts Override (Reqs FE9 Federal Emissions)
- NC7 Federal Emission Override (Reqs YF5 California or NG1 New York/Massachusetts Emissions)

POWER TEAMS (Must Specify Engine, Transmission and Rear Axle)

(Consult GVWR Selector For Minimum Equipment Required)

ENGINE	TRANSMISSION		AXLE		GVWR
	5-SP	AUTO	4.10	4.56	
HEAVY DUTY					
CC30943					
L31 V8 5700 Vortec (350 Cu In)-SFI	MW3	MT1	(a) GT5 GT5	(b) HC4 (c) HC4	9000/10000 9000/10000
L29 V8 7400 Vortec (454 Cu In)-SFI	MW3	MT1	(a) GT5 GT5	(b) HC4 (c) HC4	9000/10000 9000/10000
L65 Turbo Diesel 6.5 Liter V8 H.D. (400 Cu In)	MW3	MT1	GT5	--	9000/10000
CK30943					
L31 V8 5700 Vortec (350 Cu In)-SFI	MW3	MT1	(a) GT5 GT5	(b) HC4 (c) HC4	9200/10000 9200/10000
L29 V8 7400 Vortec (454 Cu In)-SFI	MW3	MT1	(a) GT5 GT5	(b) HC4 (c) HC4	9200/10000 9200/10000
L65 Turbo Diesel 6.5 Liter V8 H.D. (400 Cu In)	MW3	MT1	GT5	--	9200/10000

- (a) N/A YF5 Emissions
- (b) Reqs C7A GVW; N/A YF5 Emissions
- (c) Reqs C7A GVW

TIRES: (Must Specify Front and Rear) (Spare Tire and Tire Carrier Included) (Spare Matches Rear Tire)

Description	Front	* All Season ** Highway Single		Dual Rear	Front	On-Off Road Single Dual	
		Rear	Rear			Rear	Rear
C30943							
TUBELESS Steel Belted Radial							
LT215/85R16-D B/W	** XYK			YYK			
LT225/75R16-D B/W	* XHP			YHP			YHR
LT245/75R16-EB/W	* XHH	YHH					YGK
	* XHH						
K30943							
TUBELESS Steel Belted Radial							
LT215/85R16-D B/W	** XYK			YYK			
(a)LT215/85R16-D B/W					XYL		YYL
LT225/75R16-DB/W				XHR			YHR
LT225/75R16-DB/W	* XHP			YHP			
LT245/75R16-EB/W					XGK		YGK
LT245/75R16-EB/W	* XHH	YHH					

- (a) Reqs F60 Front Springs
- BW = Blackwall

C/K 3500 CREW CAB PICKUP

MUST SPECIFY:

AXLE, EMISSION, ENGINE, TIRES AND TRANSMISSION

**No Deletions Allowed. Additional Options/Upgrades (Where Indicated)
May be Ordered from the Custom Ordering Option Listing.**

	CHEYENNE	SILVERADO	
	1 S A	1 S B	1 S C
CHEYENNE DECOR	x	--	
Fleetside Body Code E63	x	x	x
SILVERADO DECOR		x	x
SILVERADO DECOR (Leather)			
Keyless Entry AU0			x
Seat, Power AG9			x
Trim, Leather Split Bench Seat (A) AE7			x

(A) May upgrade

CREW CAB PICKUP MARKETING PACKAGES

CONVENIENCE PACKAGE

ORDERING OPTION = R9A

(Reqs Peg 1SA)

Incls :

- C60 Air Conditioning
- UM6 Radio w/Cassette
- ZQ3 Tilt and Cruise

BRIGHT APPEARANCE PACKAGE

ORDERING OPTION = R9B

(Reqs Peg 1SA)

Incls :

- B85 Body Side Moldings (w/o Dual Rear Wheels)
- V22 Chrome Grille
- VB3 Chrome Front Bumper
- P06 Rally Wheels

**C/K 3500 CREW CAB PICKUP
REFER WEEKLY STOPS/LATEST UPDATE**

ADDITIONAL OPTIONS

INCL W/DECOR		OPTION
CHEY- ENNE	SILVER- ADD	
		ACKNOWLEDGEMENTS: R8S Multiple Order Numbers R8T Preliminary Invoice (Refer Vehicle Price Schedule for Prices)
		K47 AIR CLEANER: High Capacity
		AIR CONDITIONING: (One Of The Following Options Must Be Ordered w/PEG 1SA w.o Convenience Pkg R9A) Y66 Air Conditioning Not Desired C60 Air Conditioning: (Incls R134A Refrigerant) w/1SB, 1SC or R9A w/1SA
	x	V22 APPEARANCE PACKAGE: (Incls Chrome Grille, Composite Halogen Headlamps and Dual Horns) w/1SB, 1SC or R9B w/1SA
	x	AXLES, REAR: (Refer Power Teams Chart for Availability) GT5 4.10 Ratio HC4 4.56 Ratio (Incls G80 Locking Differential) G80 Locking Differential (Included w/HC4 Axle) w/HC4 w/o HC4
		TP2 BATTERY: Heavy-Duty, Auxiliary (N/A L65 Eng) (Deletes Underhood Storage Box)
		BZY BEDLINER: Under-rail
		E63 BODY CODE: Fleetside
		BUMPER EQUIPMENT: (Vehicles registered in certain states must have a rear bumper to be operated on their roads. Consult your local laws.) (Cheyenne Decor does not include a Rear Bumper)
N/A		EF1 Bumper Delete Provisions: (N/A Z82 Trailering)
	x	V83 Bumper, Chromed Rear Step w/1SB, 1SC or R9B w/o 1SA
	N/A	V43 Bumper, Painted Rear (Reqs Cheyenne Decor)
		V10 COLD CLIMATE PACKAGE: (N/A L65 Eng) (Incls Eng Block Heater)
	x	CONVENIENCE PACKAGES: ZQ3 Tilt Wheel and Speed Control w/1SB, 1SC or R9A w/1SA
		C49 DEFOGGER: Rear Window, Electric (N/A A28 Sliding Rear Window) (Reqs C60 Air)
		EMISSIONS: (Refer Emission Requirement Tab Section) FE9 Federal Emission Requirements YF5 California Emission Requirements NG1 New York/Massachusetts Emission Requirements NB8 California or New York/Massachusetts Emission Override (Reqs FE9 Federal Emissions) NC7 Federal Emission Override (Reqs YF5 California or NG1 New York/Massachusetts Emissions)
		ENGINES: (Refer Power Teams Chart for Availability) L31 V8 5700 Vortec (350 Cu In)-SFI H.D. L29 V8 7400 Vortec (454 Cu In)-SFI L65 V8 6.5 Liter Turbo Diesel (400 Cu In)-EFI (Incls Front Bumper Guards) (Deletes Underhood Storage Box)
		AJ1 GLASS: Deep Tint (Incls Light Tinted Rear Window when A28 Sliding Rear Window is Specified) w/A28 w/o A28
		GVWR: (Must Specify One) (Refer GVWR Selector Chart for Availability) C6U 9000# C6W 9200# C7A 10000#
N/A		AU0 KEYLESS ENTRY: Remote w/1SC w/o 1SC
		U01 LAMPS: Roof Marker (N/A YF5 Calif Emission w/R04 Rear Wheels) (Incl w/R05 Dual Rear Wheels) w/R05 w/R04
	x	VK3 LICENSE PLATE BRACKET: Front AU3 LOCKS, POWER DOOR: (Reqs Base PEG)

**C/K 3500 CREW CAB PICKUP
REFER WEEKLY STOPS/LATEST UPDATE**

ADDITIONAL OPTIONS

INCL W/DECOR		OPTION
CHEV- ENNE	SILVER- ADO	
		MIRRORS: DF2 Camper Type, Stainless Steel, 7.5" W x 10.5" H, Exterior w/1SB or 1SC w/1SA
		PAINT: ZY1 Solid (Refer Color/Trim Chart for Availability)
		RADIO EQUIPMENT: UM6 Electronically Tuned AM/FM Stereo Radio w/Seek-Scan, Digital Clock and Cassette Tape w/1SB, 1SC or R9A w/1SA
N/A	x	UL0 Electronically Tuned AM/FM Stereo Radio w/Seek-Scan w/Automatic Tone Control, Digital Clock, Cassette Tape, Theft Lock and Speed Compensated Volume (Incls an Enhanced Performance Speaker System)
N/A		UN0 Electronically Tuned AM/FM Stereo Radio w/Seek-Scan w/Automatic Tone Control, Compact Disc Player, Digital Clock, Theft Lock and Speed Compensated Volume (Incls an Enhanced Performance Speaker System)
N/A		UPO Electronically Tuned AM/FM Stereo Radio w/Seek-Scan w/Automatic Tone Control, Compact Disc Player, Digital Clock, Cassette Tape, Theft Lock and Speed Compensated Volume (Incls an Enhanced Performance Speaker System) (Reqs MT1 Trans)
N/A	N/A	UL5 Radio Delete
		AG9 SEATING: Power Driver's Seat (N/A A52 Bench Seat) w/1SC w/o 1SC
		SEAT TYPE: (Refer Color/Trim Chart for Availability) A52 Front Bench Seat (Incls Storage Armrest and Power Lumbar w/Custom Cloth or Leather Trim) w/1SA or w/1SB w/o Leather w/1SB with Leather
		AE7 Front 60/40 Split Bench Seat (Incls Storage Armrest and Power Lumbar w/Custom Cloth or Leather Trim) w/1SC w/1SA or with 1SB w/o Leather w/1SB w/Leather
N/A		A95 Front, Bucket, High Back Reclining (Incls Floor Console, Power Lumbar and Overhead Console) w/1SR w/1SN w/o Leather w/1SN with Leather
		NZZ SKID PLATE PACKAGE: (K30943 Only) (Incls Eng, Front Differential and Transfer Case Shields)
		F60 SPRINGS: Front, Heavy-Duty (K30943 Only)
		V76 TIRES: (Refer Tire Chart for Availability and Vehicle Price Schedule for Prices)
		ZB2 TOW HOOKS: (Std on K30943)
		TRAILERING PACKAGE: (Incls Trailer Hitch Platform) (Reqs VB3 or V43 Bumper)
		TRANSMISSIONS: (Refer Power Teams Chart for Availability)
		MW3 5-Speed Heavy Duty Manual w/Deep Low and Overdrive, Heavy-Duty
		MT1 4-Speed Electronically Controlled Automatic w/Overdrive, Heavy-Duty (Incls Transmission Oil Cooler)
	x	P06 WHEEL TRIM: Rally Wheel w/1SB, 1SC or R9B w/1SA
		WHEELS, REAR: (Must Specify One) R04 Single Rear R05 Dual Rear (Reqs C7A GVWR) (Incls U01 Roof Marker and Tailgate Lamps)
		A28 WINDOW: Sliding Rear

CREW CAB PICKUP INTERIOR AND EXTERIOR COLOR AVAILABILITY CHART ZY1 PAINT

PLEASE NOTE: Below are the interior trim color and exterior paint combinations recommended by Chevrolet. They are the only available interior and exterior combinations allowed.

TRIM LEVEL (Must Specify Seat Option and Interior Color) Seat Type	SEAT OPT	INTERIOR COLORS			
		Neutral	Blue	Gray	Red
CHEYENNE Vinyl Bench Seat	A52	52V	26V	13V	79V
SILVERADO DECOR Custom Cloth Bench Seat	A52	52D	26D	13D	79D
* Custom Leather Bench Seat	A52	52Z	26Z	13Z	79Z
Custom Cloth Reclining Split Bench Seat	AE7	52D	26D	13D	79D
* Custom Leather Reclining Split Bench Seat	AE7	52Z	26Z	13Z	79Z
Custom Cloth Reclining High Back Bkt Seats	A95	52D	26D	13D	79D
* Custom Leather Reclining High Back Bkt Seats	A95	52Z	26Z	13Z	79Z

EXTERIOR COLORS	Color Code	Paint Scheme	INTERIOR & EXTERIOR COMBINATIONS SHOWN ARE THE ONLY COMBINATIONS AVAILABLE				Wheel Flare Colors Avail or Std on (a) 4-WD
			Neutral	Blue	Gray	Red	
^ AUTUMNWOOD, LT (Metallic)	55U	ZY1	x				Autumnwood, Lt
BLACK, ONYX	41U	ZY1	x		x	x	Black, Onyx
^ BLUE, GREEN MED (Metallic)	35U	ZY1	x		x		Dk Argent
BLUE, LT (Metallic)	27U	ZY1		x	x		Dk Argent
BLUE, ROYAL MED (Metallic)	25U	ZY1	x	x	x		Dk Argent
GREEN, EMERALD (Metallic)	43U	ZY1	x		x		Dk Argent
QUICKSILVER (Metallic)	96U	ZY1		x	x	x	Quicksilver
RED, CARMINE DK (Metallic)	51U	ZY1	x		x	x	Red, Carmine Dk
RED, VICTORY	74U	ZY1	x		x	x	Dk Argent
WHITE, SUMMIT	50U	ZY1	x	x	x	x	Dk Argent

- * Leather on Seating Surface Only
- (a) Incl on Front Only w/Dual Rear Wheels

SOLID PAINT - ZY1

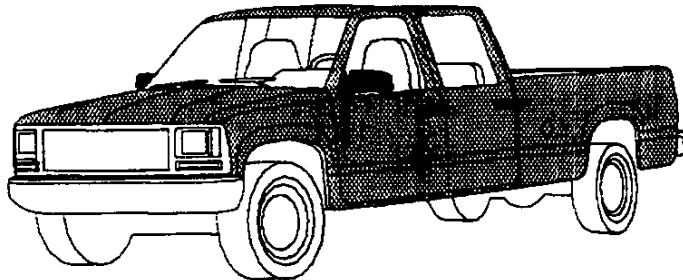

1997 NEW PRODUCT HIGHLIGHTS

CK CHASSIS-CAB

AIR BAG FOR FRONT PASSENGER ON ALL VEHICLES BELOW 8600# GVW

SPEED SENSITIVE POWER STEERING

DEALERS WILL BE REQUIRED TO ORDER OPTION YG6 (AIR CONDITIONING NOT DESIRED) IF AIR CONDITIONING IS NOT ORDERED OR IS NOT STANDARD.

THREE NEW COLORS. GREEN BLUE METALLIC, ROYAL BLUE METALLIC AND DARK CARMINE RED METALLIC.





C/K Chassis-Cab

Dealer Order Guide inserts are your first look at Chevy Truck models for 1997. Overall improvements, changes and deletions are highlighted. Use these inserts to assist you in ordering your initial shipments. (NOTE: some information is preliminary and is subject to change.)

Positioning Statement

The ideal vehicle for van, retriever, dump, stake or other commercial body, especially if GVWRs of 10,000 lbs. and 11,000 lbs. (2WD) or 12,000 lbs. (4x4) are required.

The 3500 Series straight-rail frame and parallel, flat-top rails with 34" spacing are preferred by many body suppliers.

FOCUS/FEATURE: C3500 HD Chassis-Cab with Silverado trim and PEG Group 15Q

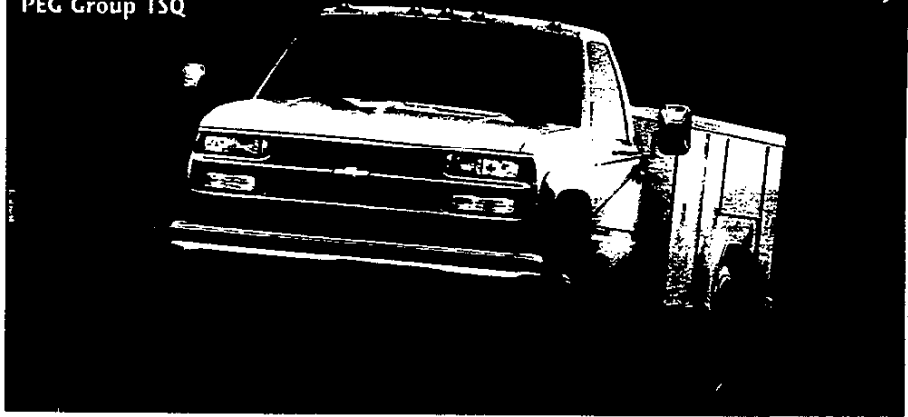

'97

FOCUS

The Focus vehicle is chosen for its saleability. It offers a mix of product attributes that most customers want. You'll want to be sure you have several of these models in stock. NOTE: model, PEG and optional equipment may vary in your locality.

FEATURE

The Feature vehicle is the model Chevy Truck plans to feature in all its advertising. It does the best job of capturing reader/viewer attention.

C3500 HD Chassis-Cab with Silverado trim and PEG Group 15Q

(image above — shown with utility body from an independent supplier)

The 1997 C/K Chassis-Cab Focus/Feature vehicle is the C3500 HD Silverado. With standard dual rear wheels, this is the ideal truck for commercial utility applications requiring light to medium payload ranges.

Ordering Recommendations:

The recommended C3500 HD Chassis-Cab content, based on national sales volume, is listed below to assist your dealership in ordering.

C3500 HD Chassis-Cab with Preferred Equipment Group 15Q includes:

- Air Conditioning
- AM/FM Stereo with Seek-Scan, Cassette Player and Digital Clock
- Tilt-Wheel™ Adjustable Steering Column
- Electronic Speed Control with Resume Speed.

Silverado uplevel decor content also features the following equipment in addition to or replacing the standard decor:

- Deluxe Front Chrome Grille Package with Bright Trim
- Dual Composite Halogen Headlamps
- Leather Wrapped Steering Wheel
- Color-Keyed Carpeting
- Color-Keyed Floor Mats
- Power Door Locks.

NOTE: Model, PEG and optional content may vary in your locality. Use the Retail Sales Analysis (RSA) to verify or select your dealership's C/K Chassis-Cab Focus/Feature vehicle content.

Trim Colors



Vinyl available in Neutral, Blue, Gray and Red.

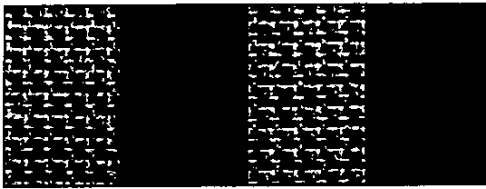

Cloth available in Neutral, Blue, Gray and Red.

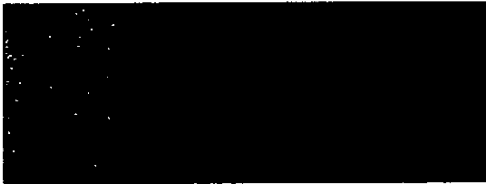

Custom Cloth available in Neutral, Blue, Gray and Red.

Seat Styles

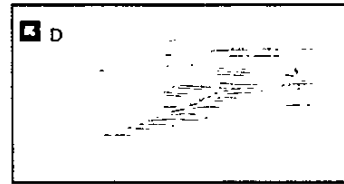
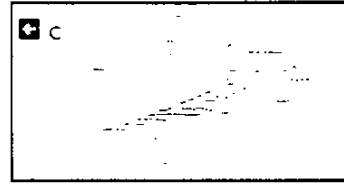
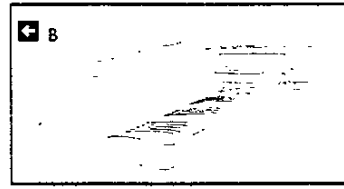
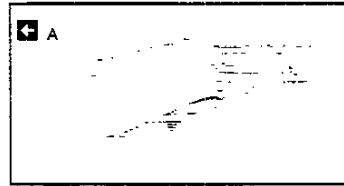

- A. Vinyl bench seat.
- B. Cloth bench seat.
- C. Custom Cloth 60/40 split-bench seat.
- D. Custom Cloth high-back bucket seats.

Wheels

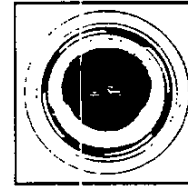

Standard 16" silver-painted steel wheels with black hub ornament — Cheyenne.

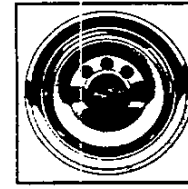

(RPO P06) 16" Rally Wheel trim — optional. Standard with Silverado.

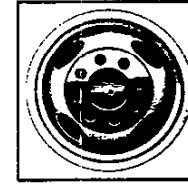

(RPO R05) Standard 16" front wheel with dual rear wheels.

Most Popular Exterior Colors with Corresponding Interior Color Availability

Chassis-Cab C3500 HD

INTERIOR MATERIAL COLORS

	Neutral	Gray
EXTERIOR COLORS		
Frost White	✓	✓
Apple Red	✓	✓
Midnight Black	✓	✓

See Order Guide for color availability by model.

Chassis-Cab (except C3500 HD)

INTERIOR MATERIAL COLORS

	Neutral	Blue	Gray	Red
EXTERIOR COLORS				
Summit White	✓	✓	✓	✓
Victory Red	✓		✓	✓
Emerald Green Metallic	✓		✓	
Light Autumnwood Metallic	✓			✓
Indigo Blue Metallic	✓	✓		
Dark Garnet Red Metallic	✓		✓	✓

See Order Guide for color availability by model.

Most Popular Exterior Colors by Percentage

Below are the anticipated four most popular C/K Chassis-Cab colors for 1997, based on national sales volume. They are listed for reference only. To identify the top-selling colors in your area, by model, use the Retail Sales Analysis (RSA).

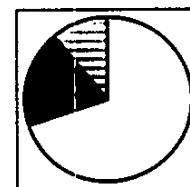

C3500 HD Only

Frost White	70%
Apple Red	15%
Midnight Black	4%
Other colors	11%

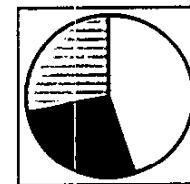

Chassis-Cab (except C3500 HD)

Summit White	45%
Victory Red	10%
Emerald Green Metallic	6%
Light Autumnwood Metallic	5%
Indigo Blue Metallic	3%
Dark Garnet Red Metallic	3%
Other colors	28%



P.D.S.E.I. helps explain 1997 models for this brand. Overall improvements, changes and deletions are highlighted. Please review the supplied information, keeping in mind that this material is provided to you before production startup — and may change.

P.D.S.E.I. (New-for-'97 features appear in color.)

P

PERFORMANCE

• **MANUAL TRANSMISSION (C/K2500 AND 3500 SERIES ONLY)** — Improved shift feel, quieter operation compared to last year's transmission. • **STANDARD VORTEC 5700 V8 ENGINE WITH SFI** — provides impressive power, smooth, quiet performance and extended maintenance intervals (not available on 3500 HD). • **AVAILABLE DIESEL POWER** — eager 6.5 Liter Turbo-Diesel V8 is available in most C/K models. An ideal choice for fleets, trailer towing and wherever greater economy is desired.

D

DURABILITY

• **100,000-MILE SPARK PLUGS** — for extended service intervals.* • **LONG-LIFE COOLANT** — good for 5 years/100,000 miles.* • **SERPENTINE BELT ACCESSORY DRIVE** — designed to last 100,000 miles. • **NO NEED TO CHECK ENGINE TIMING** — ever. • **TWO-SIDE-GALVANIZED STEEL** — on all exterior body panels (except roof); provides maximum corrosion protection. • **BUMPER TO BUMPER LIMITED WARRANTY** — protection for 3 years or 36,000 miles, with no deductible. • **6.5 LITER V8 DIESEL ENGINE 5-YEAR/100,000-MILE WARRANTY** (\$100 deductive after 3 years/36,000 miles).

*Maintenance needs vary with different uses and driving conditions.

S

SAFETY

• **DAYTIME RUNNING LAMPS** — make vehicle more visible during daylight hours. • **4-WHEEL ANTI-LOCK BRAKE SYSTEM (ABS)** — helps maintain steering control and minimizes wheel lockup on most slippery surfaces. • **STEEL SIDE-DOOR BEAMS** — add the strength and security of steel for greater protection. • **STANDARD CRUSH ZONES** — frontal structure is designed to "crush" in a controlled manner to help absorb crash energy.

E

EXTERIOR

• **BASECOAT/CLEARCOAT PAINT** — resists fading and provides a high-gloss shine for long-lasting exterior beauty. • **ANTI-CHIP FEATURE** — on lower-body surfaces helps prevent damage to finish. • **TRIM LEVELS** — choice of Cheyenne or Silverado trim levels.

I

INTERIOR

• **COMPARTMENTALIZED FRONT-BENCH SEAT ARMREST*** — offers more concealed stowage space, as well as handy coin holder, map net and writing surface. • **ILLUMINATED ENTRY FEATURE** — dome lamp remains on for 20 seconds, allowing visibility at night. • **SCOTCHGARD™ PROTECTOR** — on cloth seats, door panels and floor carpeting, resists stains for easy cleanup.

*Requires Silverado Decor and Custom Cloth trim.

Competitive Models

- Ford F-Series
- Dodge Ram.

Forecasted Percent of Mix

SERIES	
C/K2500	11%
C/K3500	89%
Total	100%
MODELS	
2WD	80%
4WD	20%*
Total	100%
TRIM LEVELS	
Cheyenne	90%
Silverado	10%
Total	100%
ENGINES	
Vortec 5700 V8 with SFI	25%
Vortec 7400 V8 with SFI	35%
6.5L V8 Turbo-Diesel HD	40%
Total	100%
TRANSMISSIONS	
5-Speed Heavy-Duty Manual with Deep Low and Overdrive	35%
4-Speed Electronically Controlled Heavy-Duty Automatic with Overdrive	65%
Total	100%

*Not available on 3500 HD.

C/K Chassis-Cab

2500 CHASSIS CAB EQUIPMENT SUMMARY

STANDARD INTERIOR FEATURES		CHEYENNE	SILVERADO
CUPHOLDERS:	DUAL IN DASH	S	S
DOOR BEAMS:	SIDE IMPACT	S	S
GAGES:	TRIP ODOMETER, OIL PRESSURE, VOLTMETER AND TACHOMETER	S	S
GLASS:	SOLAR RAY TINTED, ALL WINDOWS	S	S
JACK:	WITH WHEEL WRENCH	S	S
INSULATION:	UNDER DASH & FLOOR COVERING	S	S
LIGHTING:	DOME W/LH & RH DOOR SWITCH W/DELAYED ENTRY FEATURE , READING, ASHTRAY, GLOVE-BOX AND UNDERHOOD	S	S
POWER POINTS:	DUAL COVERED	S	S
SCOTCHGARD:	ALL CLOTH AND CARPET SURFACES	S	S
SEAT BELTS:	ADJUSTABLE HEIGHT, FRONT	S	S
WARNING TONE:	KEY-IN-IGNITION BUZZER	S	S

STANDARD EXTERIOR FEATURES		CHEYENNE	SILVERADO
FLARES:	FRONT WHEEL OPENING (K2500 ONLY)	S	S
LAMPS:	DAYTIME RUNNING	S	S
TOW HOOKS:	TWO FRONT ON 4X4 MODELS	S	S
WIPERS:	INTERMITTENT WINDSHIELD W/PULSE WASHERS	S	S
WIRE HARNESS:	7 LEAD TRAILERING	S	S

STANDARD CHASSIS FEATURES		CHEYENNE	SILVERADO
BATTERY:	HEAVY-DUTY 600 CCA	S	S
BRAKES:	POWER ASSISTED FRONT DISC, REAR DRUM 4-WHEEL ANTI-LOCK	S	S
ENGINE:	VORTEC 5700 V8 SFI	S	S
EXHAUST SYSTEM:	STAINLESS STEEL	S	S
FUEL TANK:	34 GALLON	S	S
GENERATOR:	100 AMP	S	S
<u>STEERING:</u>	<u>SPEED SENSITIVE, POWER (EVO)</u>	S	S
STORAGE BOX:	UNDERHOOD, COVERED	S	S
SUSPENSION FRT:	INDEPENDENT COIL W/2WD INDEPENDENT TORSION BAR W/4X4	S	S
SUSPENSION RR:	MULTI-LEAF SPRINGS	S	S
TRANSMISSION:	5-SPEED MANUAL W/DEEP LOW & OVERDRIVE	S	S

BOLD, ITALICS AND UNDERLINED INDICATES NEW FOR '97

REVISED: 8-19-96

1997 ORDER GUIDE

C/K 2500 CHASSIS-CAB

Page 1

Prices Shown Are Manufacturer's Suggested Retail Prices (MSRP) At The Time Of Publication. These Prices Are To Be Used Only As An Aid To Inventory Management Since MSRP Figures Change Periodically. The Vehicle Price Schedule Is The Official Pricing Documentation Of Chevrolet Motor Division And Should Be Used In Discussing Vehicle Prices With Potential Buyers. The Model Prices Shown In The Order Guide Include The Destination Freight Charges.

**2500 CHASSIS CAB
TRIM DEFINITION & OPTION SUMMARY**

INTERIOR TRIM

		CHEYENNE	SILVERADO
AIR CONDITIONING:		--	S
ASSIST HANDLES:	PASSENGER	S	S
CONVENIENCE GP:	CRUISE CONTROL AND TILT WHEEL	--	S
	POWER WINDOWS, LOCKS	--	S
DOOR TRIM:	MOLDED PLASTIC W/ARMREST	S	--
	COLOR-KEYED CLOTH AND CARPET TRIM	--	S
FLOOR COVERING:	COLOR-KEYED RUBBER	S	--
	COLOR-KEYED CARPET	--	S
	RUBBER FLOOR MATS	--	S
HEADLINER:	COLOR-KEYED CLOTH	S	S
INSULATION:	ADDITIONAL SOUND-DEADENING	--	S
MAP POCKETS:	IN PASSENGER AND DRIVER'S DOOR	--	S
RADIO:	AM/FM STEREO W/SEEK-SCAN AND CLOCK	S	--
	AM/FM STEREO W/SEEK-SCAN, CLOCK AND CASSETTE TAPE	--	S
SEATING:	VINYL BENCH	S	S
STEERING WHEEL:	SIMULATED LEATHER	S	--
	LEATHER WRAPPED	--	S
STORAGE TRAY:	FULL WIDTH BEHIND SEAT	--	S
SUNSHADES:	CLOTH COVERED W/LH STORAGE STRAP & W/RH MIRROR	S	S

EXTERIOR TRIM

		CHEYENNE	SILVERADO
BUMPER FRT:	CHROME	S	--
	CHROME W/BLACK RUB STRIP	--	S
GRILLE:	MOLDED, PAINTED ARGENT	S	--
	CHROME DELUXE	--	S
HEADLAMPS:	SINGLE RECTANGULAR HALOGEN	S	--
	DUAL COMPOSITE - HALOGEN	--	S
HORN:	SINGLE NOTE	S	--
	DUAL NOTE	--	S
MIRRORS:	BREAK-A-WAY OSRV, BLACK	S	--
	ELECTRIC, REMOTE CONTROL, BLACK	--	S
NAMEPLATES:	CHEYENNE BADGE ON B-PILLAR	S	--
	SILVERADO BADGE ON B-PILLAR	--	S
PAINT:	SINGLE TONE	S	S
WHEELS:	SILVER PAINTED W/BLACK CENTER CAP	S	--
	RALLY WHEEL TRIM	--	S

BOLD, ITALICS AND UNDERLINED INDICATES NEW FOR '97

MODEL AND BODY

Description	Model No	Body	Wheel Base
2-WHEEL-DRIVE MODEL Chassis-Cab .. CC20903		ZW9	131.5

*Includes Destination & Handling Charges

MODEL AND BODY

Description	Model No	Body	Wheel Base
4-WHEEL-DRIVE MODEL Chassis-Cab .. CK20903		ZW9	131.5

EMISSIONS (Must Specify One) (Refer Emission Requirements Section)

- FE9 Federal Emission Requirements
- YF5 California Emission Requirements
- NG1 New York/Massachusetts Emission Requirements
- NB8 California or New York/Massachusetts Emission Override (Reqs FE9 Federal Emissions)
- NC7 Federal Emission Override (Reqs YF5 California or NG1 New York/Massachusetts Emissions)

*** GVWR SELECTOR (MUST SPECIFY GVW OPTION)**

Minimum Equipment Required for GVW Rating

GVW Option Required	GVW Rating (lbs)	GAWR*	
		Front	Rear
C20903			
C6P	8600	3600	6000
K20903			
C6P	8600	4250	6000

* GAWR's shown are the minimum for each axle with equipment listed. Other GAWR's are available, and they are determined as the minimum capacity of either axle, springs or tires.

CAPACITIES

C20903

SPRINGS:	AXLES:
Front 3600	Front 3800
Rear 6084	Rear 6000

K20903

SPRINGS:	AXLES:
Front 4250	Front 4250
Rear 6084	Rear 6000

POWER TEAMS (Must Specify Engine, Transmission and Rear Axle)

(Consult GVWR Selector For Minimum Equipment Required)

ENGINE	TRANSMISSION		AXLE		GVWR
	5-SP	AUTO	3.73	4.10	
CC20903					
L31 Vortec 5700 V8 H.D. (350 Cu In)—SFI	MW3		(a) GT4	(a) GT5	8600
		MT1	GT4	GT5	8600
L29 Vortec 7400 V8 H.D. (454 Cu In)—SFI	MW3	MT1	GT4	GT5	8600
L65 Turbo Diesel 6.5 Liter V8 H.D. (400 Cu In)	MW3	MT1	GT4	GT5	8600
CK20903					
L31 Vortec 5700 V8 H.D. (350 Cu In)—SFI	MW3	MT1	(a) GT4	(a) GT5	8600
			GT4	GT5	8600
L29 Vortec 7400 V8 H.D. (454 Cu In)—SFI	MW3	MT1	GT4	GT5	8600
L65 Turbo Diesel 6.5 Liter V8 H.D. (400 Cu In)	MW3	MT1	GT4	GT5	8600

(a) N/A YF5 California Emissions

TIRES: Must Specify Front and Rear (Spare Tire Optional)

Description	All Seasons		On-Off Road		
	Front	Rear	Front	Rear	Spare
C20903					
TUBELESS Steel Belted Radial					
LT245/75R16-E B/W	XHH	YHH			ZHH
LT245/75R16-E B/W	XHH			YGK	ZGK
K20903					
TUBELESS Steel Belted Radial					
LT245/75R16-E B/W			XGK	YGK	ZGK
LT245/75R16-E B/W	XHH	YHH			ZHH

BW = Blackwall

MUST SPECIFY:

AXLE, EMISSION, ENGINE, TIRES AND TRANSMISSION

No Deletions Allowed. Additional Options/Upgrades (Where Indicated) May be Ordered from the Custom Ordering Option Listing.

	CHEYENNE		SILVERADO	
	1 S M	1 S N	1 S R	1 S R
CHEYENNE DECOR	X	--	--	
Chassis Cab ZW9	X	X	X	
SILVERADO DECOR		X		X
SILVERADO DECOR (Leather)				X
Keyless Entry AU0				X
Mirror, ISRV DD7				X
Trim, Leather Split Bench Seat AE7				X

(A) May upgrade

REGULAR CAB MARKETING PACKAGES

Preferred Equipment Group Prices

- N.C. 1SM
- PEG Savings
- **(-500.00) w/1SM and R9A
- N.C. w/1SM w/o R9A
- **(-750.00) 1SN or 1SR

**CONVENIENCE PACKAGE
ORDERING OPTION = R9A
(Reqs Peg 1SM)**

- Incls :
- C60 Air Conditioning
 - ZQ3 Tilt and Cruise
 - UM6 Radio w/Cassette

**PEG Savings Amount represents the savings for Preferred Equipment Groups.

ADDITIONAL OPTIONS

INCL W/DECOR		OPTION
CHEY- ENNE	SILVER ADD	
		ACKNOWLEDGEMENTS:
		R8S Multiple Order Numbers
		R8T Preliminary Invoice (Refer Vehicle Price Schedule for Prices)
		K47 AIR CLEANER: High Capacity
		AIR CONDITIONING: (One Of The Following Options Must Be Specified w/ PEG 1SM w/o Convenience Pkg R9A)
		YG6 Air Conditioning Not Desired
	x	C60 Air Conditioning: (Incls R134A Refrigerant) w/1SN, 1SR or R9A
		w/1SM
	x	V22 APPEARANCE PACKAGE: (Incls Chrome Grille, Composite Halogen Headlamps and Dual Horns) w/1SN or 1SR
		w/1SM
		AXLES, REAR: (Refer Power Teams Chart for Availability)
		GT4 3.73 Ratio
		GT5 4.10 Ratio
		G80 Locking Differential
		TP2 BATTERY: Heavy-Duty, Auxiliary (N/A Diesel Eng) (Deletes Underhood Storage Box)
		ZW9 BODY: Chassis-Cab
		V10 COLD-CLIMATE PACKAGE: (Incls Eng Block Heater) (Reqs Base Decor w/Diesel Eng)
	x	ZQ3 CONVENIENCE GROUP: Tilt-Wheel and Speed Control w/1SN, 1SR or R9A
		w/1SM
		EMISSIONS: (Refer Emission Requirement Tab Section)
		FE9 Federal Emission Requirements
		YF5 California Emission Requirements
		NG1 New York/Massachusetts Emission Requirements
		NB8 California or New York/Massachusetts Emission Override (Reqs FE9 Federal Emissions)
		NC7 Federal Emission Override (Reqs YF5 California or NG1 New York/Massachusetts Emissions)
		ENGINES: (Refer Power Teams Chart for Availability)
		L31 Vortec 5700 V8 (350 Cu In) - SFI
		L65 6.5 Liter V8 H.D. Turbo Diesel (400 Cu In) (Incls Bumper Guards) (Deletes Underhood Storage Box)
		KL5 Alternative Fuel (LPG or CNG Conversion Ready) (Reqs L31 Eng and Auto Trans)
		FLOOR COVERING:
N/A		BG9 Full Floor, Rubber, Color-Keyed (Replaces Carpeting and Floor Mats)
	N/A	B30 Carpet Floor Covering
	x	B32 Floor Mats (Reqs B30 Floor Covering)
		AJ1 GLASS: Deep Tinted Solar-Ray (C-K20903 Reqs A28 Sliding Rear Window)
		GVWR: (Must Specify) (Refer GVWR Selector Chart for Availability)
		C6P 8600#
N/A		AU0 KEYLESS ENTRY: Remote w/1SR
		w/1SN
		LD1 LAMPS: Roof Marker (N/A YF5 Calif Emissions)
		VK3 LICENSE PLATE BRACKET: Front
	x	AU3 LOCKS: Power Door
		MIRRORS:
		DF2 Camper Type, Stainless Steel, 7.5" W x 10.5" H, Exterior w/1SN or 1SR
		w/1SM
		DG5 Senior West Coast, LH and RH Stainless Steel, 7" W x 16" H, Exterior w/1SN or 1SR
		w/1SM
N/A		DD7 10" Electrochromic ISRV with 8 Point Compass, Interior w/1SR
		w/1SN
		PAINT, EXTERIOR: (Refer Color and Trim Chart for Availability)
		ZY1 Solid
		RADIO EQUIPMENT:
	x	UM6 Electronically Tuned AM/FM Stereo Radio w/Seek-Scan, Digital Clock and Cassette Tape w/1SN, 1SR or R9A
		w/1SM
N/A		UL0 Electronically Tuned AM/FM Stereo Radio w/Seek-Scan, Digital Clock, Automatic Tuning Control, Cassette Tape, Theft Lock and Speed Compensated Volume (Incls Enhanced Performance Speaker System)

ADDITIONAL OPTIONS

INCL W/DECOR		OPTION
CHEY- ENNE	SILVER- ADO	
N/A		RADIO EQUIPMENT: (Continued)
N/A		UN0 Electronically Tuned AM/FM Stereo Radio w/Seek-Scan, Digital Clock, Automatic Tone Control, Compact Disc Player, Theft Lock and Speed Compensated Volume (Incls Enhanced Performance Speaker System)
		UPO Electronically Tuned AM/FM Stereo Radio w/Seek-Scan, Digital Clock, Automatic Tone Control, Stereo Cassette Tape w/Search and Repeat, Compact Disc Player, Theft Lock and Speed Compensated Volume (Incls Enhanced Performance Speaker System) (Reqs MT1 Trans)
	N/A	UL5 Radio Delete
		SEAT TYPE (Refer Color/Trim Chart for Availability)
		A52 Bench Seat (Incls Storage Armrest and Power Lumbar w/Custom Cloth or Leather Trim) w/1SM or with 1SN w/o Leather w/1SN with Leather
		AE7 Reclining Split Bench Seat (Incls Storage Armrest and Power Lumbar w/Custom Cloth or Leather Trim) w/1SR w/1SM or with 1SN w/o Leather w/1SN with Leather
		A95 Reclining High Back Bucket Seats (Incls Power Lumbar) w/1SR w/1SN without Leather w/1SN with Leather
		NZZ SKID PLATE: Off-Road (K2500 Only)
		VYU SNOW PLOW PREP PACKAGE: (K20903 Only) (Incls F60 HD Front Springs)
		F60 SPRINGS, FRONT: Heavy Duty (K2500 Only) (Incl w/VYU Snow Plow) w/VYU w/o VYU
		TIRES: (Refer Tire Chart for Availability; Vehicle Price Schedule for Prices)
		V76 TOW HOOKS: Two Front (Standard on K2500 Models)
		NP1 TRANSFER CASE: Electronic Shift Control, 2-Speed (Reqs 4-Wheel Drive and Auto Trans) (Reqs ZQ3 Convenience Package or Silverado Decor)
		TRANSMISSIONS: (Refer Power Teams Chart for Availability)
		MW3 5-Speed Manual with Deep Low and Overdrive, Heavy-Duty
	x	MT1 4-Speed Electronically Controlled Automatic with Overdrive, Heavy-Duty
		P06 WHEEL TRIM: Rally Wheel w/1SN or 1SR w/1SM
		A28 WINDOWS: Sliding Rear

C/K 2500 CHASSIS-CAB INTERIOR AND EXTERIOR COLOR AVAILABILITY CHART WITH ZY1 PAINT SCHEMES

PLEASE NOTE: Below are the interior trim color and exterior paint combinations recommended by Chevrolet. They are the only available interior and exterior combinations allowed.

TRIM LEVEL (Must Specify Seat Option and Interior Color) Seat Type	SEAT OPT	INTERIOR COLORS			
		Neutral	Blue	Gray	Red
CHEYENNE (STD DECOR)					
Vinyl Bench Seat	A52	52V	26V	13V	79V
Cloth Bench Seat	A52	52C	26C	13C	79C
SILVERADO DECOR					
Vinyl Bench Seat	A52	52V	26V	13V	79V
Custom Cloth Bench Seat	A52	52D	26D	13D	79D
* Custom Leather Bench Seat	A52	522	262	132	792
* Custom Cloth Reclining Split Bench Seat	A57	52D	26D	13D	79D
* Custom Leather Reclining Split Bench Seat	A57	522	262	132	792
Custom Cloth Reclining High Back Bkt Seats	A35	52D	26D	13D	79D

EXTERIOR COLORS	Color Code	PAINT SCHEME	INTERIOR & EXTERIOR COMBINATIONS SHOWN ARE THE ONLY COMBINATIONS AVAILABLE				Wheel Flare Colors Avail or Std on 4-WD 8600 GVWR
^ AUTUMNWOOD, LT (Metallic)	55U	ZY1	x				Autumnwood, Lt
BLACK, ONYX	41U	ZY1	x		x	x	Black, Onyx
^ BLUE, GREEN MED (Metallic)	35U	ZY1	x		x		Dk Argent
BLUE, LT (Metallic)	27U	ZY1		x	x		Dk Argent
BLUE, ROYAL MED (Metallic)	25U	ZY1	x	x	x		Blue, Royal Med
GREEN, EMERALD (Metallic)	43U	ZY1	x		x		Dk Argent
QUICKSILVER (Metallic)	96U	ZY1		x	x	x	Quicksilver
RED, CARMINE DK (Metallic)	51U	ZY1	x		x	x	Red, Carmine Dk
RED, VICTORY	74U	ZY1	x		x	x	Dk Argent
WHITE, SUMMIT	50U	ZY1	x	x	x	x	Dk Argent

* Leather on Seating Surface Only

SOLID PAINT - ZY1

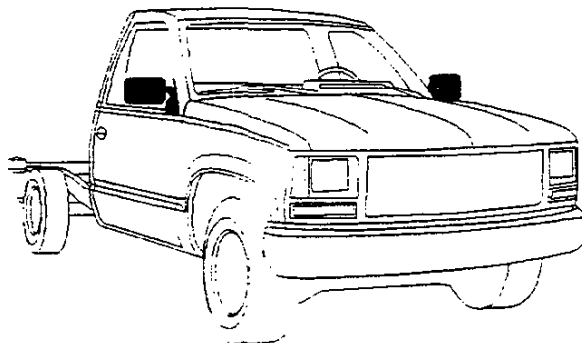

3500 CHASSIS CAB EQUIPMENT SUMMARY

STANDARD INTERIOR FEATURES

		CHEYENNE	SILVERADO
CUPHOLDERS:	DUAL IN DASH	S	S
DOOR BEAMS:	SIDE IMPACT	S	S
GAGES:	TRIP ODOMETER, OIL PRESSURE, VOLTMETER AND TACHOMETER	S	S
GLASS:	SOLAR RAY TINTED, ALL WINDOWS	S	S
INSULATION:	UNDER DASH & FLOOR COVERING	S	S
LIGHTING:	DOME W/LH & RH DOOR SWITCH W/DELAYED ENTRY FEATURE, READING, ASHTRAY, GLOVE-BOX AND UNDERHOOD	S	S
POWER POINTS:	DUAL COVERED	S	S
SCOTCHGARD:	ALL CLOTH AND CARPET SURFACES	S	S
SEAT BELTS:	ADJUSTABLE HEIGHT, FRONT	S	S
WARNING TONE:	KEY-IN-IGNITION BUZZER	S	S

STANDARD EXTERIOR FEATURES

		CHEYENNE	SILVERADO
FLARES:	FRONT WHEEL OPENING (K3500 ONLY)	S	S
LAMPS:	DAYTIME RUNNING	S	S
TOW HOOKS:	TWO FRONT ON 4X4 MODELS	S	S
WIPERS:	INTERMITTENT WINDSHIELD W/PULSE WASHERS	S	S
WIRE HARNESS:	7 LEAD TRAILERING (C*30903 MODEL ONLY)	S	S

STANDARD CHASSIS FEATURES

		CHEYENNE	SILVERADO
BATTERY:	HEAVY-DUTY 600 CCA	S	S
BRAKES:	POWER ASSISTED FRONT DISC, REAR DRUM 4-WHEEL ANTI-LOCK	S	S
ENGINE:	VORTEC 5700 V8 SFI	S	S
EXHAUST SYSTEM:	STAINLESS STEEL	S	S
FUEL TANK:	40 GAL W/003 & 403 MODELS (22 GAL TANK IN FRONT) (18 GAL TANK IN REAR) 34 GAL W/903 MODELS	S	S
GENERATOR:	100 AMP	S	S
<u>STEERING:</u>	<u>SPEED SENSITIVE, POWER (EVO)</u>	S	S
STORAGE BOX:	UNDERHOOD, COVERED	S	S
SUSPENSION FRT:	INDEPENDENT COIL W/2WD INDEPENDENT TORSION BAR W/4X4	S	S
SUSPENSION RR:	MULTI-LEAF SPRINGS	S	S
TRANSMISSION:	5-SPEED MANUAL W/DEEP LOW AND OVERDRIVE	S	S

BOLD, ITALICS AND UNDERLINED INDICATES NEW FOR '97

REVISED: 8-19-96

1997 ORDER GUIDE

C/K 3500 CHASSIS-CAB

Page 9

Prices Shown Are Manufacturer's Suggested Retail Prices (MSRP) At The Time Of Publication. These Prices Are To Be Used Only As An Aid To Inventory Management Since MSRP Figures Change Periodically. The Vehicle Price Schedule Is The Official Pricing Documentation Of Chevrolet Motor Division And Should Be Used In Discussing Vehicle Prices With Potential Buyers. The Model Prices Shown In The Order Guide Include The Destination Freight Charges.

**3500 CHASSIS CAB
TRIM DEFINITION & OPTION SUMMARY**

INTERIOR TRIM		CHEYENNE	SILVERADO
AIR CONDITIONING:		--	S
ASSIST HANDLES:		S	S
CONVENIENCE GP:	CRUISE CONTROL AND TILT WHEEL	--	S
	POWER WINDOWS AND LOCKS	--	S
DOOR TRIM:	MOLDED PLASTIC W/ARMREST	S	--
	COLOR-KEYED CLOTH AND CARPET TRIM	--	S
FLOOR COVERING:	COLOR-KEYED RUBBER	S	--
	COLOR-KEYED CARPET	--	S
	RUBBER FLOOR MATS	--	S
HEADLINER:	COLOR-KEYED CLOTH	S	S
INSULATION:	ADDITIONAL SOUND-DEADENING	--	S
MAP POCKETS:	IN PASSENGER AND DRIVER'S DOOR	--	S
RADIO:	AM/FM STEREO W/SEEK-SCAN AND CLOCK	S	--
	AM/FM STEREO W/SEEK-SCAN, CLOCK AND CASSETTE TAPE	--	S
SEATING:	VINYL BENCH	S	S
STEERING WHEEL:	SIMULATED LEATHER	S	--
	LEATHER WRAPPED	--	S
SUNSHADES:	CLOTH COVERED W/LH STORAGE STRAP & W/RH MIRROR	S	S

EXTERIOR TRIM		CHEYENNE	SILVERADO
BUMPER FRT:	CHROME	S	--
	CHROME W/BLACK RUB STRIP	--	S
GRILLE:	MOLDED, PAINTED ARGENT	S	--
	CHROME DELUXE	--	S
HEADLAMPS:	SINGLE RECTANGULAR HALOGEN	S	--
	DUAL COMPOSITE - HALOGEN	--	S
HORN:	SINGLE NOTE	S	--
	DUAL NOTE	--	S
MIRRORS:	BREAK-A-WAY OSRV, BLACK W/O F44 CHASSIS	S	--
	ELECTRIC, REMOTE CONTROL, BLACK W/O F44 CHASSIS	--	S
	RH & LH BELOW-EYE-LINE TYPE, BLACK W/F44 CHASSIS	S	--
	STAINLESS STEEL BELOW-EYE-LINE W/C7E OR C7L GVW	--	S
NAMEPLATES:	CHEYENNE BADGE ON B-PILLAR	S	--
	SILVERADO BADGE ON B-PILLAR	--	S
PAINT:	SINGLE TONE	S	S
WHEELS:	SILVER PAINTED W/BLACK CENTER CAP	S	--
	RALLY WHEEL TRIM	--	S

BOLD, ITALICS AND UNDERLINED INDICATES NEW FOR '97

**C/K3500 REGULAR CAB CHASSIS-CAB
12000 GVWR AND BELOW**

MODEL AND BODY

Description	Model No	Body	Wheel Base
2-WHEEL-DRIVE MODELS			
Chassis-Cab	CC30903	ZW9	131.5
Chassis-Cab	CC31003	ZW9	135.5
Chassis-Cab	CC31403	ZW9	159.5

MODEL AND BODY

Description	Model No	Body	Wheel Base
4-WHEEL-DRIVE MODELS			
Chassis-Cab	CK30903	ZW9	131.5
Chassis-Cab	CK31003	ZW9	135.5
Chassis-Cab	CK31403	ZW9	159.5

***GVWR SELECTOR (MUST SPECIFY GVW OPTION)**

GVW Option Required	GVW Rating (lbs)	Minimum Equipment Required For GVW Rating		GAWR*
		Front	Rear	
C30903				
C6U	9000	3600	6084	Reqs R04 Wheels and YGK or YHH Tires
C7A	10000	3600	7500	Reqs R05 Wheels (N/A KL5 Alternative Fuel)
C31003-C31403				
C7A	10000	3880	7500	
C7E	11000	4100	8250	Reqs F44 Chassis
K30903				
C6W	9200	4250	6084	Reqs R04 Wheels and YGK or YHH Tires
C7A	10000	4250	7500	Reqs R05 Wheels
K31003-K31403				
C7L	12000	4500	8600	Incls F44 Chassis

* GAWR's shown are the minimum for each axle with equipment listed. Other GAWR's are available, and they are determined as the minimum capacity of either axle, springs or tires.

CAPACITIES

C30903	
Springs:	Axles:
Front	Front
3600	3800
Rear	Rear
6084	6084
C31003-C31403	
Springs:	Axles:
Front	Front
4100	4100
Rear	Rear
7500	8600

K30903	
Springs:	Axles:
Front	Front
4250	4250
Rear	Rear
6084	6084
K31003-K31403	
Springs:	Axles:
Front	Front
4500	4500
Rear	Rear
8600	8600

**C/K3500 REGULAR CAB CHASSIS-CAB
12000 GVWR AND BELOW**

EMISSIONS (Must Specify One) (Refer Emission Requirements Section)

- FE9 Federal Emission Requirements
- YF5 California Emission Requirements
- NG1 New York/Massachusetts Emission Requirements
- NB8 California or New York/Massachusetts (Reqs FE9 Federal Emission)
- NC7 Federal Emission Override (Reqs YF5 California or NG1 New York/Massachusetts Emissions)

POWER TEAMS (Must Specify Engine, Transmission and Rear Axle)

(Consult GVWR Selector For Minimum Equipment Required)

	ENGINE	TRANSMISSION		AXLE			GVWR
	5-SP	AUTO		3.73	4.10	4.56	
		H Duty	H Duty				
CC30903							
L31 Vortec 5700 V8 H.D. (350 Cu In)-SFI	MW3			--	(a) GT5	--	9000
			MT1	--	GT5	--	9000
L31 Vortec 5700 V8 H.D. (350 Cu In)-SFI	MW3			--	(a) GT5	--	10000
			MT1	--	(a) GT5	(a) HC4	10000
L29 Vortec 7400 V8 (454 Cu In)-SFI	MW3			--	GT5	--	9000
			MT1	--	GT5	(a) HC4	10000
L29 Vortec 7400 V8 (454 Cu In)-SFI	MW3			--	GT5	(a) HC4	10000
			MT1	--	GT5	(a) HC4	10000
L65 Turbo Diesel 6.5 Liter V8 H.D. (400 Cu In)	MW3			--	GT5	--	9000/10000
			MT1	--	GT5	--	9000/10000
CK30903							
L31 Vortec 5700 V8 H.D. (350 Cu In)-SFI	MW3			--	(a) GT5	--	9200
			MT1	--	(a) GT5	--	10000
L31 Vortec 5700 V8 H.D. (350 Cu In)-SFI	MW3			--	(a) GT5	--	10000
			MT1	--	(a) GT5	--	10000
L29 Vortec 7400 V8 (454 Cu In)-SFI	MW3			--	GT5	--	9200
			MT1	--	GT5	(a) HC4	10000
L29 Vortec 7400 V8 (454 Cu In)-SFI	MW3			--	GT5	(a) HC4	10000
			MT1	--	GT5	(a) HC4	10000
L65 Turbo Diesel 6.5 Liter V8 H.D. (400 Cu In)	MW3			--	GT5	--	9200/10000
			MT1	--	GT5	--	9200/10000
CC31003-CC31403							
L31 Vortec 5700 V8 H.D. (350 Cu In)-SFI	MW3			--	(a) GT5	(a) HC4	10000
			MT1	--	GT5	HC4	10000/11000
L29 Vortec 7400 V8 (454 Cu In)-SFI	MW3			GT4	GT5	HC4	10000/11000
			MT1	GT4	GT5	HC4	10000/11000
L65 Turbo Diesel 6.5 Liter V8 H.D. (400 Cu In)	MW3			--	GT5	--	11000/11000
			MT1	--	GT5	--	11000/11000
CK31003-CK31403							
L31 Vortec 5700 V8 H.D. (350 Cu In)-SFI	MW3			--	(a) GT5	(a) HC4	12000
			MT1	--	(a) GT5	(a) HC4	12000
L29 Vortec 7400 V8 (454 Cu In)-SFI	MW3			GT4	GT5	HC4	12000
			MT1	GT4	GT5	HC4	12000
L65 Turbo Diesel 6.5 Liter V8 H.D. (400 Cu In)	MW3			GT4	GT5	--	12000
			MT1	GT4	GT5	--	12000

(a) N/A YF5 California Emissions

**C/K3500 REGULAR CAB CHASSIS-CAB
12000 GVWR AND BELOW**

TIRES:

C/K30903--C/K31*03 (Must Specify Front and Rear Tire) (Spare is Optional)

* All Seasons

** Highway

Description	Single		Dual		Single		Dual	
	Front	Rear	Rear	Rear	Front	Rear	Rear	Spare
C30903								
TUBELESS Steel Belted Radial								
LT215/85R16-D B/W	**	XYK		YYK				ZYK
LT225/75R16-D B/W	*	XHP		YHP				ZHP
LT225/75R16-D B/W	*	XHP					YHR	ZHR
LT245/75R16-E B/W	*	XHH				YGK		ZGK
LT245/75R16-E B/W	*	XHH	YHH					ZHH
C31003-C31403								
TUBELESS Steel Belted Radial								
LT215/85R16-D B/W	**	XYK		YYK				ZYK
LT215/85R16-D B/W	**	XYK					YYL	ZYL
LT225/75R16-D B/W	*	XHP		YHP				ZHP
LT225/75R16-D B/W	*	XHP					YHR	ZHR
K30903								
TUBELESS Steel Belted Radial								
LT215/85R16-D B/W	**	XYK		YYK				ZYK
(b)LT215/85R16-D B/W					XYL		YYL	ZYL
LT225/75R16-D B/W	**	XHP		YHP				ZHP
LT225/75R16-D B/W					XHR		YHR	ZHR
LT245/75R16-E B/W					XGK	YGK		ZGK
LT245/75R16-E B/W	*	XHH	YHH					ZHH
K31003-K31403								
TUBELESS Steel Belted Radial								
LT215/85R16-D B/W	**	XYK		YYK				ZYK
(b)LT215/85R16-D B/W					XYL		YYL	ZYL
LT225/75R16-D B/W	*	XHP		YHP				ZHP
LT225/75R16-D B/W					XHR		YHR	ZHR

- (a) Reqs C7A GVW
(b) Reqs F60 Front Springs

B/W = Blackwall

**C/K3500 REGULAR CAB CHASSIS-CAB
12000 GVWR AND BELOW**

MUST SPECIFY:

AXLE, EMISSION, ENGINE, TIRES AND TRANSMISSION

**No Deletions Allowed. Additional Options/Upgrades (Where Indicated)
May be Ordered from the Custom Ordering Option Listing.**

	SILVERADO		
	CHEYENNE	1 S M	1 S R
CHEYENNE DECOR	x	--	--
Chassis Cab..... ZW9	x	x	x
SILVERADO DECOR		x	x
SILVERADO DECOR (Leather)			x
Keyless Entry			x
Mirror, ISRV			x
Trim, Leather Split Bench Seat			x

REGULAR CAB MARKETING PACKAGES

Preferred Equipment Group Prices

- N.C. 1SM
- PEG Savings
- **(-500.00) w/1SM and R9A
- **(-750.00) 1SN or 1SR

CONVENIENCE PACKAGE

- ORDERING OPTION = R9A
- (Reqs PEG 1SM)
- Incls :
- C60 Air Conditioning
- ZQ3 Tilt and Cruise
- UM6 Radio w/Cassette

**PEG Savings Amount represents the savings for Preferred Equipment Groups.

**C/K3500 REGULAR CAB CHASSIS-CAB
12000 GVWR AND BELOW**

ADDITIONAL OPTIONS

INCL W/DECOR		OPTION
CHEY- ENNE	SILVER- ADO	
		ACKNOWLEDGEMENTS: R8S Multiple Order Numbers R8T Preliminary Invoice (Refer Vehicle Price Schedule for Prices) K47 AIR CLEANER: High Capacity AIR CONDITIONING: (One Of The Following Options Must Be Specified w/PEG 1SM w/o Convenience Pkg R9A) YG6 Air Conditioning Not Desired C60 Air Conditioning: (Incls R134A Refrigerant) w/1SN, 1SR or R9A w/1SM x VZ2 APPEARANCE PACKAGE: (Incls Chrome Grille, Composite Halogen Headlamps and Dual Horns) w/1SN or 1SR w/1SM AXLES, REAR: (Refer Power Teams Chart for Availability) GT4 3.73 Ratio GT5 4.10 Ratio HC4 4.56 Ratio (C-K30903 Incls G80 Locking Differential) w/CK31**3 w/C-K30903 G80 Locking Differential (Included w/HC4 on C-K30903) w/HC4 & C-K30903 w/o HC4 & C-K30903 or A/C/K31**3 GTY Wide Track (N/A C-K30903) TP2 BATTERY: Heavy-Duty, Auxiliary (N/A Diesel Eng) (Deletes Underhood Storage Box) ZW9 BODY CODE: Chassis-Cab F44 CHASSIS: Equipment Heavy-Duty (Avail on 11000 GVW Only) 4-Wheel Drive 2-Wheel Drive x VD COLD-CLIMATE PACKAGE: (Incls Eng Block Heater) (Reqs Base Decor w/Diesel Eng) ZQ3 CONVENIENCE GROUP: Comfortilt Steering and Speed Control w/1SN, 1SR or R9A w/1SM EMISSIONS: (Refer Emission Requirement Tab Section) FE9 Federal Emission Requirements YF5 California Emission Requirements NG1 New York/Massachusetts Emission Requirements NB8 California or New York/Massachusetts Emission Override (Reqs FE9 Federal Emissions) NC7 Federal Emission Override (Reqs YF5 California or NG1 New York/Massachusetts Emissions) ENGINES: (Refer Power Teams Chart for Availability) L31 Vortec 5700 V8 (350 Cu In)-SFI H.D. L29 Vortec 7400 V8 (454 Cu In)-SFI L85 6.5 Liter (400 Cu In) V8 Turbo Diesel (Deletes Underhood Storage Box) KL5 Alternative Fuel (LPG and CNG Conversion Ready) (Reqs L31 Eng and Auto Trans) FLOOR COVERING: N/A BG9 Full Floor, Rubber, Color-Keyed (Replaces Carpeting and Floor Mats) N/A B30 Carpet Floor Covering N/A B32 Floor Mats (Reqs B30 Floor Covering) NQZ FUEL TANK DELETE: 18-Gal Capacity Rear Mounted (Contact Body Manufacturer) (Reqs C-K31*03) AJ1 GLASS: Deep Tinted Solar Ray (Reqs A28 Sliding Rear Window) GVWR: (Must Specify One) (Refer GVWR Selector Chart for Availability) C6U 9,000# C6W 9,200# C7A 10,000# C7E 11,000# C7L 12,000# N/A AU0 KEYLESS ENTRY: Remote w/1SR w/1SN LD1 LAMPS: Roof Marker (Incl w/R05 Dual Rear Wheels) (Std on C-K31*03 Models) (w/R04 Single Rear Wheels Reqs FE9 or NG1 Emissions) w/R05 w/R04 x VK3 LICENSE PLATE BRACKET: Front AU3 LOCKS: Power Door MIRRORS: DF2 Camper Type, Stainless Steel, Exterior 7.5" W x 10.5" H w/1SN or 1SR w/1SM

REVISED: 8-19-96

1997 ORDER GUIDE

C/K 3500 CHASSIS-CAB

Page 15

Prices Shown Are Manufacturer's Suggested Retail Prices (MSRP) At The Time Of Publication. These Prices Are To Be Used Only As An Aid To Inventory Management Since MSRP Figures Change Periodically. The Vehicle Price Schedule Is The Official Pricing Documentation Of Chevrolet Motor Division And Should Be Used In Discussing Vehicle Prices With Potential Buyers. The Model Prices Shown In The Order Guide Include The Destination Freight Charges.

**C/K3500 REGULAR CAB CHASSIS-CAB
12000 GVWR AND BELOW**

ADDITIONAL OPTIONS

INCL W/DECOR		OPTION
CHEY- ENNE	SILVER- ADO	
		MIRRORS: (Continued)
		DG5 Senior West Coast Type. LH and RH Stainless Steel, Interior 7" W x 16" H w/1SN or 1SR
N/A		DD7 10" Electrochromic ISRV with 8 Point Compass, Interior w/1SR
	x	D45 Below-Eye-Line Type: Stainless Steel, 9" W x 6.5" H, Exterior (Reqs C7E or C7L GVW) w/1SN or 1SR
		ZY1 PAINT, EXTERIOR: Solid (Refer Color/Trim Chart for Availability)
	x	RADIO EQUIPMENT: UM6 Electronically Tuned AM/FM Stereo Radio w/Seek-Scan, Digital Clock and Cassette Tape w/1SN, 1SR or R9A
N/A		UL0 Electronically Tuned AM/FM Stereo Radio w/Seek-Scan, Digital Clock, Automatic Tone Control, Cassette Tape, Theft Lock and Speed Compensated Volume (Incls an Enhanced Performance Speaker System)
N/A		UN0 Electronically Tuned AM/FM Stereo Radio w/Seek-Scan, Digital Clock, Automatic Tone Control, Compact Disc Player, Theft Lock and Speed Compensated Volume (Incls an Enhanced Performance Speaker System)
N/A		UPO Electronically Tuned AM/FM Stereo Radio w/Seek-Scan, Digital Clock, Automatic Tone Control, Stereo Cassette Tape w/Search, Compact Disc Player, Theft Lock and Speed Compensated Volume (Incls an Enhanced Performance Speaker System) (Reqs MT1 Trans)
	N/A	UL5 Radio Delete
		SEAT TYPE: (Refer Color/Trim Chart for Availability)
		A52 Bench Seat (Incls Storage Armrest and Power Lumbar w/Custom cloth or Leather Trim) w/1SN or with 1SN w/o Leather
N/A		AE7 Reclining Split Bench Seat (Incls Storage Armrest and Power Lumbar w/Custom cloth or Leather Trim) w/1SR
		w/1SN or with 1SN w/o Leather
		w/1SN with Leather
N/A		A95 Reclining High Back Bucket Seats (Incls Power Lumbar) w/1SR
		w/1SN without Leather
		w/1SN with Leather
		NZZ SKID PLATE: Off-Road (K3500 Only) (Incls Eng, Front Differential and Transfer Case Shields)
		VYU SNOW PLOW PREP PACKAGE: (K3500 Only) (Incls F60 Front Springs)
		F60 SPRINGS: Front, Heavy-Duty. (K3500 Only) (Incl w/VYU Pkg) w/VYU
		w/o VYU
		F61 STABILIZER SHAFT: Rear (N/A C-K30903)
		TIRES: (Refer Tire Chart for Availability and Vehicle Price Schedule for Pricing)
		V76 TOW HOOKS: Two Front (Std on K3500 Models)
		TRANSMISSIONS: (Refer Power Teams Chart for Availability)
		MW3 5-Speed Manual w/Deep Low and Overdrive, Heavy-Duty
		MT1 4-Speed Automatic w/Overdrive, Heavy-Duty
		WHEELS, REAR: One Of The Following Wheel Options Must Be Specified on C-K30903 Models
		RO4 Single, Rear (Reqs YHH or YGK Tires and C-K30903 Model)
		RO5 Dual, Rear (N/A YHH or YGK Tires) w/CK31003-C-K31403
		w/C-K30903
	x	PO6 WHEEL TRIM: Rally Wheel Trim w/1SN or 1SR
		w/1SM
		A28 WINDOW: Sliding Rear

C/K 3500 CHASSIS-CAB INTERIOR AND EXTERIOR COLOR AVAILABILITY CHART WITH ZY1 PAINT SCHEMES

PLEASE NOTE: Below are the interior trim color and exterior paint combinations recommended by Chevrolet. They are the only available interior and exterior combinations allowed.

TRIM LEVEL (Must Specify Seat Option and Interior Color) Seat Type	SEAT OPT	INTERIOR COLORS			
		Neutral	Blue	Gray	Red
CHEYENNE (STD DECOR)					
Vinyl Bench Seat	A52	52V	26V	13V	79V
Cloth Bench Seat	A52	52C	26C	13C	79C
SILVERADO DECOR					
Vinyl Bench Seat	A52	52V	26V	13V	79V
Custom Cloth Bench Seat	A52	52D	26D	13D	79D
* Custom Leather Bench Seat	A52	522	262	132	792
* Custom Cloth Reclining Split Bench Seat	AE7	52D	26D	13D	79D
* Custom Leather Reclining Split Bench Seat	AE7	522	262	132	792
Custom Cloth Reclining High Back Bkt Seats	A95	52D	26D	13D	79D

EXTERIOR COLORS	Color Code	PAINT SCHEME	INTERIOR & EXTERIOR COMBINATIONS SHOWN ARE THE ONLY COMBINATIONS AVAILABLE				Wheel Flare Colors Avail or Std on (a) 4-WD
^ AUTUMNWOOD, LT (Metallic)	55J	ZY1	x				Autumnwood, Lt
BLACK, ONYX	4U	ZY1	x		x	x	Black, Onyx
^ BLUE, GREEN MED (Metallic)	35U	ZY1	x		x		Dk Argent
BLUE, LT (Metallic)	27U	ZY1		x	x		Dk Argent
BLUE, ROYAL MED (Metallic)	25U	ZY1	x	x	x		Blue, Royal Med
GREEN, EMERALD (Metallic)	43J	ZY1	x		x		Dk Argent
QUICKSILVER (Metallic)	96U	ZY1		x	x	x	Quicksilver
RED, CARMINE DK (Metallic)	51U	ZY1	x		x	x	Red, Carmine Dk
RED, VICTORY	74U	ZY1	x		x	x	Dk Argent
WHITE, SUMMIT	50U	ZY1	x	x	x	x	Dk Argent

* Leather on Seating Surface Only
(a) Incl on Front Only w/Dual Rear Wheels

SOLID PAINT - ZY1

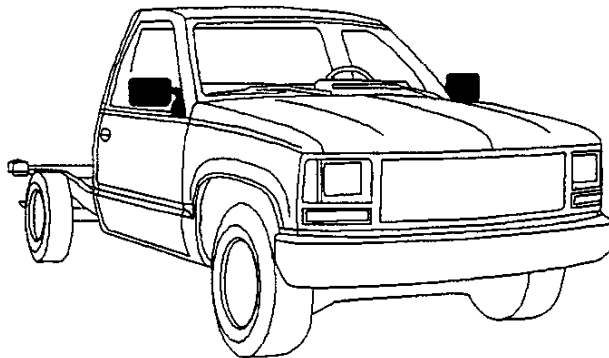

NOTES

DIMENSIONS (CONT.)

MODEL	C/K 1500 PICKUP REG.-CAB/EXT.-CAB SPORTSIDE/FLEETSIDE			C/K 2500 PICKUP REG.-CAB/EXT.-CAB FLEETSIDE			C/K3500 PICKUP REG.-CAB/EXT.- CAB FLEETSIDE		C/K 3500 PICKUP CREW-CAB	
	MODEL NUMBER	C/K10703 C/K10753	C/K10903 C/K10953	C/K20753 C20903	C/K20903 C/K20953	C/K20903 C/K20953	C/K30903 C/K30953	C/K30903 C/K30953	R04	R05
BODY CODE/ OPTION CODE	E62	E63	E63	C5Z	C6P	C6P	C6U & C6W	C7A	R04	R05
EXTERIOR DIMENSIONS										
Ground to Top of Rear Load Floor (in.)										
Reg.-Cab-2WD	32.4	32.2	33.0	—	36.8	35.3	36.1	—	—	—
Reg.-Cab-4WD	32.8	32.6	—	—	40.0	35.2	35.8	—	—	—
Ext.-Cab-2WD	31.4	30.3	32.6	—	34.8	—	34.1	—	—	—
Ext.-Cab-4WD	32.4	34.3	—	33.8	34.9	—	34.1	—	—	—
Crew Cab-2WD	—	—	—	—	—	—	—	—	34.2	34.7
Crew Cab-4WD H502	—	—	—	—	—	—	—	—	34.2	34.7
Ground Clearance (in.)										
Front/Rear										
Reg.-Cab-2WD		6.8/6.6	7.1/7.3	—/—	7.1/7.3		8.4/6.4		7.5/6.4	
Reg.-Cab-4WD		8.7/8.0	—	—/—	8.7/7.3		6.3/6.4		7.3/6.4	
Ext.-Cab-2WD H148		6.9/6.9	7.7/7.2	—/—	7.7/7.2		8.0/6.4		—	
Ext.-Cab-4WD H153		9.0/8.4	—	9.0/7.8	9.0/7.8		6.3/6.4		—	
Turning Diameter Curb-to-Curb (ft)										
Reg.-Cab-2WD/4WD	39.8/40.7	43.7/44.7	43.7/—	—/—	43.4/45.0	43.4/45.0	43.4/45.0	53.8/55.7	53.8/55.7	53.8/55.7
Ext.-Cab-2WD/4WD	46.6/47.6	50.6/51.6	46.6/—	—/47.9	50.2/51.9	50.2/51.9	50.2/51.9	—/—	—/—	—/—
Track Width (in.)										
Front/Rear										
Reg.-Cab-2WD	63.6/64.6	63.6/64.6	62.6/63.6	—/—	N/A	63.3/64.3	N/A	63.3/64.3	N/A	N/A
Reg.-Cab-4WD	64.1/63.5	62.1/63.5	—/—	—/—	64.1/63.9	68.6/64.3	N/A	68.6/64.3	N/A	N/A
Ext.-Cab-2WD W101	63.6/63.6	62.6/63.6	62.6/63.6	—/—	62.6/63.6	—/—	63.3/64.3	—/—	—/—	—/—
Ext.-Cab-4WD W102	64.1/63.5	62.1/63.1	—/—	64.1/63.9	64.1/63.9	—/—	68.6/64.3	—/—	—/—	—/—
CARGO BOX										
Inside Length at Floor (in.) L505	78.7	97.6	78.7/97.6	97.6	97.6	97.6	97.6	97.6	97.6	97.6
Inside Width at Top Rear (in.) W204	49.0	60.2	60.2	60.2	60.2	60.2	60.2	60.2	60.2	60.2
Inside Width at Floor (in.) W203	49.0	64.4	64.4	64.4	64.4	64.4	64.4	64.4	64.4	64.4
Inside Width between Wheelhousings (in.) W201	49.1	49.1	49.1	49.1	49.1	49.1	49.1	49.1	49.1	49.1
Inside Height (in.) H503	19.2	19.2	19.2	19.2	19.2	19.2	19.2	19.2	19.2	19.2
Tailgate Width (in.) (Top)	50.9	62.0	62.0	62.0	62.0	62.0	62.0	62.0	62.0	62.0
Cargo Volume (cu ft)	42.1	55.6	69.1	55.6/69.1	69.1	69.1	69.1	69.1	69.1	69.1
SIGN PANEL AREA (in.)										
Reg.-Cab	17 x 48 3/4	17 x 48 3/4	17 x 48 3/4	17 x 48 3/4	17 x 48 3/4	17 x 48 3/4	17 x 48 3/4	17 x 48 3/4	—	—
Ext.-Cab	17 x 77 1/2	17 x 77 1/2	17 x 77 1/2	17 x 77 1/2	17 x 77 1/2	17 x 77 1/2	17 x 77 1/2	17 x 77 1/2	—	—
Crew-Cab	—	—	—	—	—	—	—	—	17 x 85	17 x 85
INTERIOR DIMENSIONS										
CAB										
Headroom (in.)										
Front/Rear ¹ H61/H63	39.9/37.5	39.9/37.5	39.9/37.5	39.9/37.5	39.9/37.5	39.9/37.5	39.9/37.5	39.9/37.5	39.9/40.8	39.9/40.8
Legroom (in.)										
Front/Rear ¹ L34/L51	41.7/34.8	41.7/34.8	41.7/34.8	41.7/34.8	41.7/34.8	41.7/34.8	41.7/34.8	41.7/34.8	41.7/37.9	41.7/37.9
Shoulder Room (in.)										
Front/Rear ¹ W3/W4	65.4/67.6	65.4/67.6	65.4/67.6	65.4/67.6	65.4/67.6	65.4/67.6	65.4/67.6	65.4/67.6	65.4/64.9	65.4/64.9
Hip Room (in.)										
Front/Rear ¹ W5/W6	60.0/64.2	60.0/64.2	60.0/64.2	60.0/64.2	60.0/64.2	60.0/64.2	60.0/64.2	60.0/64.2	60.0/59.3	60.0/59.3
Extended-Cab Cargo Volume (cu ft) w/o Rear Seat	40.5	40.5	40.5	40.5	40.5	40.5	40.5	40.5	—	—

¹ Rear dimensions apply to Extended-Cab and Crew-Cab models.
N/A—Not available at time of publication.

C/K PICKUP

TIRES				
KEY: ALS = ALL-SEASON SBR = STEEL-BELTED RADIAL PLY BW = BLACKWALL ALT = ALL TERRAIN WL = WHITE LETTERED HWY = HIGHWAY OOR = ON-OFF ROAD WOL = WHITE OUTLINE LETTERED				
TIRE DESCRIPTION		FRONT	REAR	SPARE
P235/75R15	ALS/SBR/BW	XFL	YFL	ZFL
P235/75R15	ALS/SBR/WL	XFN	YFN	ZFN
P245/75R16	ALT/SBR/BW	XGA	YGA	ZGA
P245/75R16	ALT/SBR/WOL	XGB	YGB	ZGB
P265/75R16	ALT/SBR/BW	XGC	YGC	ZGC
P265/75R16	ALT/SBR/WOL	XGD	YGD	ZGD
LT215/85R16D	HWY/SBR/BW	XYK	YYK	ZYK
LT215/85R16D	OOR/SBR/BW	XYL	YYL	ZYL
LT225/75R16D	ALS/SBR/BW	XHP	YHP	ZHP
LT225/75R16D	OOR/SBR/BW	XHR	YHR	ZHR
LT245/75R16C	OOR/SBR/BW	XBN	YBN	ZBN
LT245/75R16C	OOR/SBR/WOL	XBX	YBX	ZBX
LT245/75R16E	ALS/SBR/BW	XHH	YHH	ZHH
LT245/75R16E	OOR/SBR/BW	XGK	YGK	ZGK

DIMENSIONS

MODEL	C/K 1500 PICKUP REG.-CAB/EXT.-CAB SPORTSIDE/FLEETSIDE			C/K 2500 PICKUP REG.-CAB/EXT.-CAB FLEETSIDE		C/K3500 PICKUP REG.-CAB/EXT.- CAB FLEETSIDE		C/K 3500 PICKUP CREW-CAB		
	C/K10703 C/K10753	C/K10903 C/K10953	E63	C5Z	C6P	C6P	C8U & C6W	C7A	R04	R05
EXTERIOR DIMENSIONS										
BODY										
Wheelbase (in.)										
Reg.-Cab	117.5	131.5	131.5	131.5	131.5	131.5	131.5	131.5	168.5	
Ext.-Cab L101	141.5	155.5	141.5	155.5	155.5	155.5	155.5	155.5	—	
Overall Length (in.) w/o										
Rear Bumper										
Reg.-Cab	194.5	213.4	213.4	213.4	213.4	213.4	213.4	213.4	250.9	
Ext.-Cab L103	238.5	237.4	218.5	237.4	237.4	237.4	237.4	237.4	—	
Overall Height (in.)										
Reg.-Cab-2WD	70.8	70.0	71.2	73.8	73.8	73.4	73.2	73.9	73.9	73.9
Reg.-Cab-4WD	72.7	72.5	—	76.0	76.0	74.0	74.0	74.5	74.5	74.5
Ext.-Cab-2WD	70.6	70.1	71.3	73.1	73.1	—	72.6	—	—	—
Ext.-Cab-4WD H431	72.6	73.2	73.7	74.0	74.0	—	73.4	—	—	—
Maximum Width (in.) W103	77.1	76.8	76.8	76.8	76.8	76.8	94.3	76.8	94.3	94.3
Bumper to Axle (in.)										
Front L104	35.4	35.4	35.4	35.4	35.4	35.4	35.4	35.4	35.4	
Rear Overhang (w/o bumper) L105	41.6	46.5	41.6/46.5	46.5	46.5	46.5	46.5	46.5	46.5	
Cab to Rear Axle (in.) L404	41.9	55.9	41.9	55.9	55.9	55.9	55.9	55.9	55.9	
Cab to End of Frame (in.)	78.7	97.6	78.7	97.6	97.6	97.6	97.6	97.6	97.6	
Bumper to Back of Cab (in.)										
Reg.-Cab	111.0		111.0	111.0	111.0	111.0		148.5		—
Ext.-Cab L403	135.0		135.0	135.0	135.0	135.0		—		—

PREFERRED EQUIPMENT GROUPS

Preferred Equipment Groups (PEGs) are convenient option packages that can save your customers money. They would pay appreciably more by buying all the options in a Preferred Equipment Group as individual options. (Savings based on a comparison of Manufacturer's Suggested Retail Price of option packages vs. MSRP of individual options purchased separately.) See your 1997 Chevrolet Truck Order Guide and Vehicle Price Schedule for specific information.

OPTIONS

These options can be ordered individually in addition to the Preferred Equipment Groups if not already included. See your 1997 Chevrolet Truck Order Guide for availability and restrictions. The Option Codes are listed in **bold type**.

Air Cleaner, High Capacity	K47
Air Conditioning	C60
Appearance Package: Chrome Grille, Composite Headlamps and Dual Horns	V22
Axles, Rear	
3.08	GU4
3.42	GU6
3.73	GT4
4.10	GT5
4.56	HC4
Axle, Rear Locking Differential	G80
Battery, Heavy-Duty, Auxiliary	TP2
Bedliner	BZY
Bumper Delete Provisions (Please consult your local & state operator regulation)	EF1
Bumper, Painted Rear Step (N/A with YE9)	V43
Bumper, Chrome Rear Step w/Rub Strip	VB3
Bumper, Chrome Front Deluxe w/Rub Strip	VG3
Chassis Equipment, Heavy-Duty	F44
Cold Climate Package (includes Engine Block Heater)	V10
Convenience Package, Driver's (includes Tilt-Wheel™ Steering and Electronic Speed Control)	ZQ3
Cooling System	
Engine oil cooler	KC4
Heavy duty transmission	KNP
Defogger, Rear Window (53 models req. YE9, 43 models req. C60)	C49
Emissions	
Federal	FE9
California	YF5
Massachusetts/New York	NG1
Federal emissions override	NC7
Cal./Mass./N.Y. emissions Override	NB8
Engines	
VORTEC 4300 SFI V6	L35
VORTEC 5000 SFI V8	L30
VORTEC 5700 SFI V8	L31
VORTEC 7400 SFI V8	L29
6.5L V8 Turbo Diesel	L56
6.5L V8 Turbo Diesel Alternative Fuel (LPG and CNG conversion-ready) ..	KL5
Floor Covering	
Full floor rubber, color-keyed (requires YE9) (N/A on Crew-Cab models)	BG9
Carpet (N/A with X81 Work Truck, YE9 or Crew-Cab models)	B30
Front Floor Mats (N/A on Crew-Cab models)	B32
Rear floor mats (Extended-Cab models only)	B33

Glass, Solar-Ray® Deep-Tinted, side and Rear Windows (03 models require A28 rear slider window)	AJ1
GVWR	
6100 lb	C5M
6200 lb	Q4B
6600 lb	C5S
6800 lb	C5U
7200 lb	C5Z
8600 lb	C6P
9000 lb	C6U
9200 lb	C6W
10,000 lb	C7A
Keyless Entry, Remote	AU0
Lamps, Roof Marker (included w/Dual Rear Wheels R05) (N/A with 1500 series models)	U01
License Plate Bracket, Front	VK3
Locks, Power Door	AU3
Marketing Packages (See Order Guide for details)	
Convenience Package	R9A
Bright Appearance Package	R9B
Commercial Option Package	R9C
Sport Package (C/K10703 w/E62 only)	BYP
Mirrors	
Electrochromic (includes light-sensitive rearview mirror and eight-point compass. Requires YE9)	DD7
Exterior Camper Type (LH and RH stainless steel. Mirror head: 7.5" x 10.5")	DF2
Moldings, Bodyside Black with bright trim	B85
Off-Road Chassis Package (K1500 only) (includes skid plate NZZ. Req. YE9)	Z71
Paint, Exterior	
Solid	ZY1
Conventional Two-Tone (requires YE9)	ZY2
Deluxe two-tone (requires YE9)	ZY4
Radio Equipment	
Radio delete	UL5
ETR AM/FM Stereo Radio w/Seek-Scan, Stereo Cassette, Digital Clock	UM6
ETR AM/FM Stereo Radio with Seek- Scan with Automatic Tone Control, Stereo Cassette, Digital Clock, TheftLock™ and Speed-Compensated Volume (includes an enhanced perfor- mance speaker system) Req YE9	UL0
ETR AM/FM Stereo Radio with Seek- Scan with Automatic Tone Control, Compact Disc Player, Digital Clock, TheftLock™ and Speed-Compensated Volume (includes an enhanced speaker system) Req. YE9	UN0

ETR AM/FM Stereo Radio with Seek- Scan with Automatic Tone Control, Compact Disc Player, Cassette, Digital Clock, TheftLock™ and Speed- Compensated Volume (includes an enhanced performance speaker system) Reqs YE9	UP0
Recreational Sales Package (For information purposes only. YF7 is available for ordering through authorized CQACP manufacturers only)	YF7
Seat Type	
Bench Seat	A52
60/40 reclining split bench seat	AE7
Reclining high-back bucket seat	A95
Seat, Power Driver's (Crew-Cab and Extended-Cab models with YE9 only)	AG9
Seat, Rear 3-Passenger Bench Not Desired (Extended-Cab Only) ..	YG4
Shock Absorbers, Front and Rear, Heavy-Duty	F51
Gas 46mm (Bilstein)	FG5
Skid Plate (4x4 only)	NZZ
Snow Plow Prep Package (reg-cab 4x4 only)	VYU
Springs, Front Heavy-Duty (4x4 only) ..	F60
"Third Door" (located on passenger side on C/K10753 Models.) Req YE9	E24
Tow Hooks, Front (4x2 only)	V76
Trailer Special Equipment (includes weight distributing hitch platform)	Z82
Transfer Case, Electronic Shift Control (1500 and 2500 Series only)	NP1
Transmissions	
5-Speed Manual w/Overdrive	MG5
5-Speed Manual w/Overdrive	M50
5-Speed Manual w/Deep Low and Overdrive, HD	MW3
4-Speed Electronically Controlled Automatic w/overdrive	M30
4-Speed Electronically Controlled Automatic w/overdrive, HD	MT1
Wheels	
Rally Trim	P06
Cast Aluminum (15" x 7") (C1500) ...	N90
Cast Aluminum (16" x 7") (K1500) ...	PF4
Chrome (15" x 7") (C1500)	N83
Dual Rear (C/K3500 only)	R05
Windows, Sliding Rear	A28
Work Truck (See Order Guide for details)	X81

C/K PICKUP

INTERIOR EQUIPMENT (CONT.)		CHEYENNE: (STANDARD)	SILVERADO (YE9)
KEY: ■ = STANDARD, — = NOT INCLUDED			
FLOOR COVERING	Embossed color-keyed rubber mat on Regular- and Extended-Cab models. Rubber mat is black in Crew-Cab models. Color-keyed carpeting and removable color-keyed rubber floor mats. NOTE: Scotchgard™ Fabric Protector on all cloth floor coverings.	■ —	— ■
GAGES	Include fuel level, odometer, oil pressure, trip odometer, speedometer, telltale lights, engine temperature, voltmeter and tachometer.	■	■
GLOVE BOX	Latched door with light.	■	■
HEADLAMP WARNING TONE	Headlamps on.	■	■
HEADLINER	Full-length color-keyed cloth with matching retainer moldings. Crew-Cab: Full-length color-keyed cloth with matching retainer moldings and three assist handles (RF, LR, RR).	■ ■	■ ■
HEATER	Includes front heater with windshield and side window defoggers.	■	■
HEATER DUCT	Rear seat area. Located on floor under front seats (Crew-Cab models only.)	■	■
INSULATION	Provided on dash panels, cowl tops and sides, and doors. Extended-Cabs have additional insulation on the rear quarter and back panels and on floor coverings. Extra insulation is provided with diesel engines. Also includes insulation on headliners. Also includes insulation on Regular-Cab back panels.	■ — —	■ ■ ■
LIGHTING	Includes dome, reading, ashtray, glove box, and cargo lamps with illuminated entry feature.	■	■
MIRROR	10-inch rearview. 10-inch electrochromic rearview (Crew-Cab only).	■ —	■ ■
RADIOS	ETR AM/FM stereo with Seek-Scan and digital clock. Includes two 6" diameter front- door-mounted speakers and two 4" x 6" rear-mounted speakers located above the door (4 speakers in all). ETR AM/FM stereo with Seek-Scan, digital clock, and cassette . Includes two 6" diameter front- door-mounted speakers and two 4" x 6" rear-mounted speakers located above the door (4 speakers in all).	■ —	— ■
SEATS	Regular-Cab: Front 3-passenger bench with head restraints and folding backrest. Front 3-passenger bench with head restraints and folding center armrest. Power lumbar and front seatback storage pockets included. Front center armrest provides lift-up storage space that features a coin holder, a map strap on the inside lid and a writing board. Extended-Cab: Front reclining 3-passenger 60/40 split bench with head restraints and folding rear bench seat. Front reclining 3-passenger 60/40 split bench with head restraints and folding rear bench seat includes center armrest. Power lumbar with front seats only and front seat-back storage nets included. Front center armrest provides lift-up storage space that features a coin holder, a map strap on the inside lid and a writing board. Crew-Cab: Front 3-passenger bench with head restraints and folding backrest and rear 3-passenger bench with adjustable backrest. Front reclining 3-passenger 60/40 split bench with head restraints and folding rear bench seat includes center armrest. Power lumbar with front seats only and front seat-back storage nets included. Front center armrest provides lift-up storage space that features a coin holder, a map strap on the inside lid and a writing board. NOTE: Scotchgard™ Fabric Protector on all cloth seats and cloth door trim panels.	■ — ■ — ■ —	— ■ — ■ — ■
STEERING WHEEL	Simulated leather. Leather.	■ —	— ■
STORAGE TRAY	Full width behind seat on floor (Regular-Cab models only).	—	■
SUNSHADE	Color-keyed cloth RH and LH, padded with storage strap on LH unit and visor mirror on RH unit. Crew Cab: Padded, color-keyed cloth RH and LH sunshades with extenders and illuminated mirrors. LH sunshade has storage strap.	■ —	■ ■
TOOLS	Mechanical jack and wheel wrench located behind front seat or on rear compartment floor.	■	■
WINDOWS	Power.	—	■
WINDSHIELD WIPERS	Intermittent.	■	■

C/K PICKUP

EXTERIOR EQUIPMENT (CONT.)		CHEYENNE (STANDARD)	SILVERADO (YES)
KEY: ■ = STANDARD, — = NOT INCLUDED			
INSULATION	Hood and cab-to-fender.	—	■
LAMPS	Center high-mounted stop lamp/cargo lamp. Underhood. (Fixed.)	■ ■	■ ■
MIRRORS	RH and LH below-eyeline type, painted black. Head size is 8.5" x 5.0". RH and LH electric below-eyeline, outside rearview type, painted black. Head size is 8.5" x 5.0".	■ —	— ■
MOLDINGS	Black bodyside with bright trim and bright wheel opening (E63 only). (N/A K2500 C6P, K3500, Sportside and R05 models). Crew-Cab: Bright trim with wheel opening molding (w/R04).	— ■	■ ■
RUNNING LAMPS	Daytime.	■	■
SPARE TIRE AND WHEEL	Full-size.	■	■
SPARE TIRE CARRIER	Winch-type carrier mounted under frame at rear.	■	■
TAILGATE	Removable.	■	■
TIRES	Steel Belted Radials. C/K1500 Reg.-Cab (2WD) P235/75R15. Ext.-Cab (2WD) P235/75R15. Reg.-Cab (4WD) P245/75R16. Ext.-Cab (4WD) P245/75R16. C/K2500 Reg.-Cab (2WD/4WD) and Ext.-Cab (2WD) LT225/75R16D. All models with C6P: LT245/75R16E. C/K3500 Reg.-Cab, Ext.-Cab and Crew-Cab w/R04: LT245/75R16E. Reg.-Cab and Ext.-Cab (2WD) w/R05: LT225/75R16C/D. Reg.-Cab, Ext.-Cab (4WD) and Crew-Cab R05: LT225/75R16D.	■	■
WHEEL FLARES	4x4 at or above 8600 GVW.	■	■
WHEELS	Silver painted steel wheels with black hub ornament. (Argent painted on Crew-Cab) 15.0" x 7.0": C/K 1500 (2WD). 16.0" x 6.5": C/K 1500 (4WD), C/K 2500, C/K 3500 w/R04, C/K 3500 w/R05 (front only). 16.0" x 6.0": C/K 3500 w/R05 (rear only). Rally wheel trim. Crew-Cab: Rally trim.	■ — —	— ■ ■
WINDOWS	Swing-out rear quarter on Extended-Cab models only.	■	■
WIRING	Eight-wire harness for trailering purposes (Includes CHMSL).	■	■

INTERIOR EQUIPMENT		CHEYENNE (STANDARD)	SILVERADO (YES)
AIR BAG*	Driver's side air bag and Passenger side air bag. Passenger side includes a suppression switch to deactivate air bag when rear facing child seat is used. (not included on models at or above 8600 lb GVWR)	■	■
AIR CONDITIONING	Front.	—	■
ARMRESTS	RH and LH padded, integral with door panels.	■	■
ASSIST HANDLES	Passenger side.	■	■
CAB BACK PANELS	Color-keyed carpet.	—	■
CIGARETTE LIGHTER	Located on instrument panel. Includes ashtray light and 2 auxiliary covered power outlets.	■	■
CUPHOLDERS	Two located in the dash.	■	■
DOMELAMP	Switch in LH and RH door jamb (two dome lamps with front door actuated switches on Crew-Cab). Dome lamp includes delayed illuminated entry. Switches in all four doors on Crew-Cab models.	■ —	■ ■
DOOR LOCKS	Power.	—	■
DOOR TRIM	Vinyl color-keyed door trim panels with padded insert armrest, map pockets, large easily accessible door handles, and door reflectors. Color-keyed soft vinyl with cloth insert, map pockets with carpet trim. large easily accessible door handles and door reflectors with lights. NOTE: Scotchgard™ Fabric Protector on all cloth panels and trim.	■ —	— ■
DOORS	Side-door guard beams.	■	■
DRIVER'S CONVENIENCE GROUP	Speed Control and Tilt-Wheel™.	—	■

*Always wear your safety belts.

C/K PICKUP

FRONT AXLES								
Availability	K1500 & K2500 w/7200 GVWR		K2500 w/C6P & K3500			K30943		
Make/Capacity (lb)	American Axle/3925		American Axle/4250			American Axle/4500		
Pinion and Ring Gear Type	Hypoid		Hypoid			Hypoid		
Ratio	3.42	3.73	3.73	4.10	4.56	4.10	4.56	
Pinion Teeth	12	11	11	10	9	10	9	
Ring Gear Teeth	41	41	41	41	41	41	41	
Ring Gear Diameter (in.)	8.25	8.25	9.25	9.25	9.25	9.25	9.25	
Differential Type	2-Pinion Tapered Roller		2-Pinion Tapered Roller			2-Pinion Tapered Roller		
Lubricant Capacity (pints)	4.5		4.9			4.9		

Note: Axle ratio availability depends on model, powertrain, and emissions selected.

TRIM LEVELS

Chevrolet offers C/K Pickups in two primary trim levels — “Cheyenne” and “Silverado.” The following chart details major standard features. See your 1997 Chevrolet Truck Order Guide for details.

CHASSIS EQUIPMENT		CHEYENNE (STANDARD)	SILVERADO (YE9)
KEY: ■ = STANDARD, -- = NOT INCLUDED			
BRAKES	Power-assisted, front disc, rear drum, self-adjusting. Four-wheel anti-lock system. Includes brake/transmission interlock.	■	■
EXHAUST	Single. Aluminized stainless steel.	■	■
FRAME	All-welded ladder-type, channel design and boxed front-end section. Section modulus (cu in.): Reg.-Cabs — 2.66 on C/K 1500 and C/K 2500 (2WD); 3.27 on C/K1500 and C/K2500 (4WD); 5.26 on C/K 2500 /C6P and C/K3500 (2WD); 5.25 on C/K2500 w/C6P and C/K3500 (4WD). Ext.-Cabs — 3.37 on C/K1500 and C/K2500 (2WD); 4.06 on C/K1500 and C/K2500 (4WD); 6.06 on C/K 2500 w/C6P and C/K3500. Crew-Cab — 7.49 on all models.	■	■
FUEL TANK	25.0 gallon (approx.) capacity on C/K10703/53 and C/K20753 models. 34.0 gallon (approx.) capacity on all other models.	■	■
REAR AXLE	Hypoid semi-floating on C/K1500 and 2500. Full-floating on C/K 2500/C6P w/L65 and C/K3500.	■	■
SHOCK ABSORBERS	25mm: C/K 1500 front and rear; 32mm: Front and rear on C/K2500 at 7200 lb GVWR and C/K3500; Rear on C/K2500 at 8600 lb and C/K3500; 35mm: Front on C/K2500 at 8600 lb GVWR, C/K 3500 and Crew-Cab.	■	■
STABILIZER BAR	4x2: Front 1.25 in.; 4x4: Front 1.18 in.	■	■
STEERING	Integral power; Speed Sensitive (E.V.O.)	■	■
SUSPENSION, FRONT	4x2: Independent with computer-selected coil springs. 4x4: Independent with computer-selected torsion bars.	■	■
SUSPENSION, REAR	C/K1500 and 2500: Semi-elliptic two-stage multileaf springs. C/K3500: Semi-elliptic two-stage multileaf springs main/auxiliary.	■	■
TOW HOOKS	Two front on 4x4s.	■	■

EXTERIOR EQUIPMENT			
AIR DAM	Dark argent (not included on models at or above 8600 lb GVW).	■	■
BUMPER, FRONT	Bright appearance. Bright appearance (includes black rub strip with bright trim).	■	■
BUMPER, REAR	Bright appearance with black rub strip and step pad.	■	■
GLASS	Solar-Ray® tinted glass.	■	■
GRILLE	Molded plastic painted argent with argent air intake areas. Deluxe front appearance package with bright grille and bright trim with medium argent intake areas.	■	■
HEADLAMPS	Single rectangular halogen. Dual composite halogen.	■	■
HORN	Single electric note. Dual low- and high-note.	■	■

POWERTRAINS

Chevrolet offers a variety of engines, transmissions and rear axle ratios for the C/K Pickups. The following charts detail basic engine, transmission, and axle specifications. See your 1997 Chevrolet Truck Order Guide for specific details.

ENGINES						
ENGINE	VORTEC 4300 V6	VORTEC 5000 V8	VORTEC 5700 V8	VORTEC 7400 V8 HD	6.5L V8 TURBO DIESEL	6.5L V8 TURBO DIESEL HD
Order Code Restrictions	L35 6600 GVW or Under	L30 Up To 7200 GVW	L31 All Applications	L29 At or Above 8500 GVW	L56 8500 GVW or Under	L65 Above 8500 GVW
SAE Net Horsepower @ RPM	200 @ 4400	230 @ 4600	255 @ 4600	290 @ 4000	180 @ 3400	190 @ 3400
SAE Net Torque lb-ft @ RPM	255 @ 2800	285 @ 2800	330 @ 2800	410 @ 3200	360 @ 1800	385 @ 1800
Fuel System	SFI	SFI	SFI	SFI	Indirect Fuel Injection	Indirect Fuel Injection
Clutch Size (in.)	11	12	12	12	12	12
Standard Battery Cold Cranking Amps @ 0°F	600	600	600	600	2 @ 600 each	2 @ 600 each
Standard Alternator Maximum Capacity (Amps)	100	100	100	124	100	100

TRANSMISSIONS					
	MANUAL			AUTOMATIC	
	MANUAL 5-SPEED W/OVERDRIVE	MANUAL 5-SPEED W/OVERDRIVE	MANUAL 5-SPEED W/OVERDRIVE AND DEEP LOW HEAVY-DUTY	ELECTRONICALLY CONTROLLED AUTOMATIC 4-SPEED OVERDRIVE W/TORQUE CONVERTER CLUTCH (4L60-E)	ELECTRONICALLY CONTROLLED AUTOMATIC 4-SPEED OVERDRIVE W/TORQUE CONVERTER CLUTCH HEAVY-DUTY (4L80-E)
Transmission Order Code	MG5	M50	MW3	M30	MT1
Application	8500 GVW or Under (w/L35, L30)	8500 GVW or Under (w/L31 only)	Above 8500 GVW (w/L31, L65, L29)	8500 GVW or Under	Above 8500 GVW and Turbo Diesel
Synchronized Speeds	1/2/3/4/5	1/2/3/4/5	1/2/3/4/5	—	—
Gear Ratios					
First	4.02	3.49	5.61	3.06	2.48
Second	2.32	2.16	3.04	1.63	1.48
Third	1.40	1.40	1.67	1.00	1.00
Fourth	1.00	1.00	1.00	0.70	0.75
Fifth	0.73	0.73	0.75	—	—
Reverse	3.55	3.55	5.04	2.29	2.08
Power Take-Off	No	No	Yes	No	No

REAR AXLES											
Availability	(See Order Guide)			(See Order Guide)		(See Order Guide)		(See Order Guide)		(See Order Guide)	
Make	American Axle			American Axle		American Axle		American Axle		American Axle	
Capacity (lb)	3750 Semi-Floating			4800 Semi-Floating		6000 Semi-Floating		6000 Full-Floating		6084-7500 Full-Floating	
Pinion and Ring Gear Type	Hypoid			Hypoid		Hypoid		Hypoid		Hypoid	
Axle Ratio Code	GU4	GU6	GT4	GU6	GT4	GT4	GT5	GT4	GT5	GT5	HC4
Ratio	3.08	3.42	3.73	3.42	3.73	3.73	4.10	3.73	4.10	4.10	4.56
Pinion Teeth	13	12	11	12	11	11	10	11	10	10	9
Ring Gear Teeth	40	41	41	41	41	41	41	41	41	41	41
Ring Gear Diameter (in.)	8.6	8.6	8.6	9.5	9.5	9.5	9.5	10.5	10.5	10.5	10.5

Note: Axle ratio availability depends on model, powertrain, and emissions selected.

C/K PICKUP

SERIES	MODEL NUMBER/ BODY CODE/ OPTION CODE	PASSENGER CAPACITY (STD./OPT.)	STANDARD ENGINE/ TRANS.	OPTIONAL ENGINE/ TRANS.	GVWR (LB)	GAWR (LB) FRONT/ REAR	BASE PAYLOAD (LB)	MAXIMUM TRAILER WT./ TONGUE LOAD (LB) PROPERLY EQUIPPED	MAXIMUM TRAILER WT./ KINGPIN LOAD (LB) PROPERLY EQUIPPED
FOUR-WHEEL-DRIVE MODELS (CONT.)									
K2500 REGULAR-CAB									
FLEETSIDE LONG-BOX HD	CK20903/E63/ C6P YHH or YGK	3/2	5700 V8/M5	5700 V8/A4 7400 V8/M5/A4 6.5L V8/M5/A4	8600	4250/6000	3-35	7500/900 10000/1000 8000/950	7500/2500 10500/2000 6000/2000
K2500 EXTENDED-CAB									
FLEETSIDE SHORT-BOX	CK20753/E63/ C6P YGK or YHH	6/5/3	5700 V8/M5	5700 V8/A4 7400 V8/M5/A4 6.5L V8/M5/A4	8600	4250/6000	3383	7500/900 10000/1000 8000/950	7500/2500 10500/2000 5000/2300
FLEETSIDE LONG-BOX HD	CK20953/E63/ C6P YGK or YHH	6/5/3	5700 V8/M5	5700 V8/A4 7400 V8/M5/A4 6.5L V8/M5/A4	8600	4250/6000	3130	7500/900 10000/1000 8000/950	7500/2500 10500/2000 8000/2000
K3500 REGULAR-CAB									
FLEETSIDE LONG-BOX	CK30903/E63/ YGK or YHH	3/2	5700 V8/M5	5700 V8/A4 7400 V8/M5/A4 6.5L V8/M5/A4	9200	4250/6084	3981	7000/850 10000/1000 7500/900	7000/3000 10000/3000 7500/3000
FLEETSIDE LONG-BOX DUAL REAR WHEELS	CK30903/E63/ R05	3/2	5700 V8/M5	5700 V8/A4 7400 V8/M5/A4 6.5L V8/M5/A4	10000	4250/7500	*	7000/850 10000/1000 7500/900	7000/3000 12000/3000 7500/3000
K3500 EXTENDED-CAB									
FLEETSIDE LONG-BOX DUAL REAR WHEELS	CK30953/E63/ R05	6/5/3	5700 V8/M5	5700 V8/A4 7400 V8/M5/A4 6.5L V8/M5/A4	10000	4250/7500	4176	7000/850 10000/1000 7500/900	7000/3000 12000/3000 7500/3000
K3500 CREW-CAB									
SINGLE REAR WHEELS	CK30943/E63	6/5	5700 V8/M5	5700 V8/A4 7400 V8/M5/A4 6.5L V8/M5/A4	9200	4500/6084	3319	6500/800 10000/1000 7500/900	6500/3000 10000/3000 7500/3000
DUAL REAR WHEELS	CK30943/E63/ R05	6/5	5700 V8/M5	5700 V8/A4 7400 V8/M5/A4 6.5L V8/M5/A4	10000	4500/7500	*	8000/950 10000/1000 7500/900	8000/3000 12000/3000 7500/3000

*Please refer to the Weights section at the back of the Tech Guide to determine optional payloads.

C/K PICKUP

SERIES	MODEL NUMBER/ BODY CODE/ OPTION CODE	PASSENGER CAPACITY (STD./OPT.)	STANDARD ENGINE/ TRANS.	OPTIONAL ENGINE/ TRANS.	GVWR (LB)	GAWR (LB) FRONT/ REAR	BASE PAYLOAD (LB)	MAXIMUM TRAILER WT./ TONGUE LOAD (LB) PROPERLY EQUIPPED	MAXIMUM TRAILER WT./ KINGPIN LOAD (LB) PROPERLY EQUIPPED
FOUR-WHEEL-DRIVE MODELS									
K1500 REGULAR-CAB									
SPORTSIDE SHORT-BOX	CK10703/E62	3/2	4300 V6/M5	4300 V6/A4 5000 V8/M5/A4 5700 V8/M5/A4	6100	3600/3750	1802	5000/600 6000/750 6500/800	- 6000/1000 6500/1000
FLEETSIDE SHORT-BOX WT1500	CK10703/E63/ X81	3/-	4300 V6/M5	4300 V6/A4	6100	3600/3750	**	5000/600	-
FLEETSIDE SHORT-BOX	CK10703/E63	3/2	4300 V6/M5	4300 V6/A4 5000 V8/M5/A4 5700 V8/M5/A4	6100	3600/3750	1813	5000/600 6000/750 6500/800	- 6000/1000 6500/1000
FLEETSIDE LONG-BOX WT1500	CK10903/E63/ X81	3/-	4300 V6/M5	4300 V6/A4	6100	3600/3750	**	5000/600	-
FLEETSIDE LONG-BOX	CK10903/E63	3/2	4300 V6/M5	4300 V6/A4 5000 V8/M5/A4 5700 V8/M5/A4	6100	3600/3750	1871	5000/600 6000/750 6500/800	- 6000/1000 6500/1000
K1500 EXTENDED-CAB									
SPORTSIDE SHORT-BOX	CK10753/E62	6/5/3	4300 V6/M5	4300 V6/A4 5000 V8/M5/A4 5700 V8/M5/A4	6200	3600/3750	1823	5000/600 6000/750 6500/800	- 6000/1000 6500/1000
SPORTSIDE SHORT-BOX	CK10753/E62/ F44	6/5/3	4300 V6/M5	4300 V6/A4 5000 V8/M5/A4 5700 V8/M5/A4	6600	3600/3750	**	5000/600 6000/750 6500/800	- 6000/1000 6500/1000
FLEETSIDE SHORT-BOX	CK10753/E63	6/5/3	4300 V6/M5	4300 V6/A4 5000 V8/M5/A4 5700 V8/M5/A4	6200	3600/3750	1834	5000/600 6000/750 6500/800	- 6000/1000 6500/1000
FLEETSIDE SHORT-BOX	CK10753/E63/ F44	6/5/3	4300 V6/M5	4300 V6/A4 5000 V8/M5/A4 5700 V8/M5/A4 6.5L V8/A4	6600	3600/3750	**	5000/600 6000/750 6500/800 7000/850	- 6000/1000 6500/1000
FLEETSIDE LONG-BOX	CK10953/E63	6/5/3	5000 V8/M5	5000 V8/A4 5700 V8/M5/A4	6200	3600/3750	1364	6000/750 6500/800	6000/1000 6500/1000
FLEETSIDE LONG-BOX	CK10953/E63/ F44	6/5/3	5000 V8/M5	5000 V8/A4 5700 V8/M5/A4 6.5L V8/A4	6600 6800	3600/3750	**	6000/750 6500/800 7000/850	6000/1000 6500/1000

*5th-wheel trailering is not recommended.

**Please refer to the Weights section at the back of the Tech Guide to determine optional payloads.

C/K PICKUP

SERIES	MODEL NUMBER/ BODY CODE/ OPTION CODE	PASSENGER CAPACITY (STD./OPT.)	STANDARD ENGINE/ TRANS.	OPTIONAL ENGINE/ TRANS.	GVWR (LB)	GAWR (LB) FRONT/ REAR	BASE PAYLOAD (LB)	MAXIMUM TRAILER WT./ TONGUE LOAD (LB) PROPERLY EQUIPPED	MAXIMUM TRAILER WT./ KINGPIN LOAD (LB) PROPERLY EQUIPPED
TWO-WHEEL-DRIVE MODELS (CONT.)									
C2500 EXTENDED-CAB									
FLEETSIDE SHORT-BOX	CC20753/E63	6/5/3	5000 V8/M5	5000 V8/A4 5700 V8/M5/A4 6.5L V8/A4	7200	3600/4670	2763	6500/800 7000/850 7500/900	6500/2000 7000/2000 7500/1600
FLEETSIDE LONG-BOX HD	CC20953/E63/ C6P/ YHH or YGK	6/5/3	5700 V8/M5	5700 V8/A4 7400 V8/M5/A4 6.5L V8/M5/A4	8600	3600/6000	3516	8000/950 10000/1000 8500/1000	8000/3000 11000/2500 8500/2500
C3500 REGULAR-CAB									
FLEETSIDE LONG-BOX	CC30903/E63 YGK or YHH	3/2	5700 V8/M5	5700 V8/A4 7400 V8/M5/A4 6.5L V8/M5/A4	9000	3600/6084	4162	7500/900 10000/1000 8000/950	7500/3000 10500/3000 8000/3000
FLEETSIDE LONG-BOX DUAL REAR WHEELS	CC30903/E63/ R05	3/2	5700 V8/M5	5700 V8/A4 7400 V8/M5/A4 6.5L V8/M5/A4	10000	3600/7500	*	9000/1000 10000/1000 8000/950	9000/3000 12500/3000 8000/3000
C3500 EXTENDED-CAB									
FLEETSIDE LONG-BOX DUAL REAR WHEELS	CC30953/E63/ R05	6/5/3	5700 V8/M5	5700 V8/A4 7400 V8/M5/A4 6.5L V8/M5/A4	10000	3600/7500	4573	9000/1000 10000/1000 8000/950	9000/3000 12500/3000 8000/3000
C3500 CREW-CAB									
SINGLE REAR WHEELS	CC30943/E63	6/5	5700 V8/M5	5700 V8/A4 7400 V8/M5/A4 6.5L V8/M5/A4	9000	4100/6084	3491	7000/850 10000/1000 8000/950	7000/3000 10500/3000 8000/3000
DUAL REAR WHEELS	CC30943/E63/ R05	6/5	5700 V8/M5	5700 V8/A4 7400 V8/M5/A4 6.5L V8/M5/A4	10000	4100/7500	*	8500/1000 10000/1000 8000/950	8500/3000 12500/3000 8000/3000

See the following pages for 4-wheel-drive models.

*Please refer to the Weight section at the back of the Tech Guide to determine optional payloads.

MODEL SELECTION SUMMARY

Use the chart below to choose the model that fits your customer's needs. Please note that the Base Payloads shown reflect the maximum allowable weight of cargo that can be carried in a standard model, including occupants. (They are calculated by subtracting curb weight from the GVWR.) To calculate payloads for models with optional equipment, please refer to the WEIGHTS section in the back of this book or consult your 1997 GM PROSPEC. Also, the Maximum Trailer Weights shown below are based on vehicles that are properly equipped. See your Chevrolet Truck Order Guide for specific details.

SERIES	MODEL NUMBER/ BODY CODE/ OPTION CODE	PASSENGER CAPACITY (STD./OPT.)	STANDARD ENGINE/ TRANS.	OPTIONAL ENGINE/ TRANS.	GVWR (LB)	GAWR (LB) FRONT/ REAR	BASE PAYLOAD (LB)	MAXIMUM TRAILER WT./ TONGUE LOAD (LB) PROPERLY EQUIPPED	MAXIMUM TRAILER WT./ KINGPIN LOAD (LB) PROPERLY EQUIPPED
TWO-WHEEL-DRIVE MODELS									
C1500 REGULAR-CAB									
SPORTSIDE SHORT-BOX	CC10703/E62	3/2	4300 V6/M5	4300 V6/A4 5000 V8/M5/A4 5700 V8/M5/A4	6100	3200/3686	2219	5000/600 5500/700 7000/850	* 5500/1200 7000/1200
FLEETSIDE SHORT-BOX WT 1500	CC10703/E63/ X81	3/-	4300 V6/M5	4300 V6/A4	6100	3200/3686	**	5000/600	*
FLEETSIDE SHORT-BOX	CC10703/E63	3/2	4300 V6/M5	4300 V6/A4 5000 V8/M5/A4 5700 V8/M5/A4	6100	3200/3686	2230	5000/600 5500/700 7000/850	* 5500/1200 7000/1200
FLEETSIDE LONG-BOX WT 1500	CC10903/E63/ X81	3/-	4300 V6/M5	4300 V6/A4	6100	3200/3686	**	5000/600	*
FLEETSIDE LONG-BOX	CC10903/E63	3/2	4300 V6/M5	4300 V6/A4 5000 V8/M5/A4 5700 V8/M5/A4	6100	3200/3686	2081	5000/600 5500/700 7000/850	* 5500/1200 7000/1200
C1500 EXTENDED-CAB									
SPORTSIDE SHORT-BOX	CC10753/E62	6/5/3	4300 V6/M5	4300 V6/A4 5000 V8/M5/A4 5700 V8/M5/A4	6200	3500/3686	2016	5000/600 5500/700 7000/850	* 5500/1200 7000/1200
FLEETSIDE SHORT-BOX	CC10753/E63	6/5/3	4300 V6/M5	4300 V6/A4 5000 V8/M5/A4 5700 V8/M5/A4	6200	3500/3686	2027	5000/600 5500/700 7000/850	* 5500/1200 7000/1200
FLEETSIDE LONG-BOX	CC10953/E63	6/5/3	5000 V8/M5	5000 V8/A4 5700 V8/M5/A4	6200	3500/3686	1804	5500/700 7000/850	5500/1200 7000/1200
C2500 REGULAR-CAB									
FLEETSIDE LONG-BOX	CC20903/E63	3/2	5000 V8/M5	5000 V8/A4 5700 V8/M5/A4 6.5L V8/A4	7200 7200	3150/4670 3400/4800	2901	6500/800 7000/850 7500/900	6500/2000 7000/2000 7500/1600
FLEETSIDE LONG-BOX HD	CC20903/E63/ C6P/ YHH or YGK	3/2	5700 V8/M5	5700 V8/A4 7400 V8/M5/A4 6.5L V8/M5/A4	8600	3600/6000	**	8000/950 10000/1000 8500/1000	3000/3000 3000/2500 8500/2500

See the following pages for additional 2- and 4-Wheel-Drive Models.

*5th-wheel trailering is not recommended.

**Please refer to the Weights section at the back of the Tech Guide to determine optional payloads.

C/K PICKUP INTRODUCTION

C/K PICKUP

The 1997 C/K Pickups are available in two trim levels: the "Cheyenne"(standard) and the "Silverado"(uplevel).

Changes on the C/K Pickup for 1997 include:

- New Passenger Side Air Bag with Suppression Switch to Deactivate Air Bag when Rear Facing Child Seat is used (8500# GVW or less)
- New Venture 4500 Manual Transmission (MW3)
- 4-Speed 4L60-E Automatic Transmission Enhancements (M30)
- 4-Speed 4L80-E Automatic Transmission Enhancements (MT1)
- Revised Keyless Entry System
- Improved Turn Radius (K1500 Series)
- New Electronic Variable Orifice (E.V.O.) Steering. Reduces low speed and static steering effort
- Three New Exterior Colors
- DEX-COOL™ Extended Life Engine Coolant Change interval upgraded to 5 years/150,000 miles

C/K CHASSIS-CAB

DIMENSIONS

MODEL	C/K2500 CHASSIS- CAB REGULAR- CAB	C/K3500 CHASSIS-CAB REGULAR-CAB	C/K3500 STRAIGHT FRAME CHASSIS-CAB	C 3500HD CHASSIS-CAB			CREW-CAB CHASSIS-CAB			
MODEL NUMBER	CC/K20903/ ZW9	CC/K30903/ ZW9/R04	CC/K30903/ ZW9/R05	CC/K31003/ ZW9	CC/K31403/ ZW9	CC/31003/ ZW9/C5B	CC31403/ ZW9/C5B	CC31803/ ZW9	CC/K30943/ ZW9/R04	CC/K30943/ ZW9/R05
EXTERIOR DIMENSIONS										
BODY										
Wheelbase (in.) L101	131.5	131.5	131.5	135.5	159.5	135.5	159.5	183.5	168.5	168.5
Overall Length (in.) L103	208.6	208.6	208.6	221.9	245.9	224.5	248.5	272.6	246.1	246.1
Overall Height (in.)										
2WD	73.8	73.4	73.2	73.0	72.5	77.7	77.3	77.2	74.4	73.9
4WD H431	73.9	74.0	74.0	73.5	73.2	—	—	—	75.0	74.5
Maximum Width (in.) W103	76.8	76.8	92.2	84.2	84.2	84.2	84.2	85.8	76.8	94.3
Bumper to Axle Frt (in.) L104	35.4	35.4	35.4	35.4	35.4	37.9	37.9	37.9	35.4	35.4
Rear Axle to End of Frame (in.) L105	41.7	41.7	41.7	51.0	51.0	51.0	51.0	51.0	41.7	41.7
Cab to Rear Axle (in.) L404	55.9	55.9	55.9	60.0	84.0	60.0	84.0	108.0	55.9	55.9
Cab to End of Frame (in.) L103 L403	97.6	97.6	97.6	111.0	135.0	111.0	135.0	159.0	97.6	97.6
Bumper to Back of Cab (in.) L403	111.0	111.0	111.0	111.0	111.0	113.6	113.6	113.6	148.5	148.5
Inside Metal Top of Frame (in.) ¹										
2WD	32.2	32.1	32.0	31.6	31.7	31.7	31.5	31.7	31.3	30.8
4WD	32.1	32.1	31.7	30.9	30.9	—	—	—	31.6	31.0
Ground Clearance (in.)										
Front-2WD	7.1	8.4	8.4	8.9	8.9	8.9	8.9	10.8	7.5	7.5
Front-4WD H148	8.7	6.3	6.3	5.8	5.8	—	—	—	7.3	7.3
Rear-2WD	7.3	6.4	6.4	6.4	6.4	6.4	6.4	6.4	6.4	6.4
Rear-4WD H153	7.3	6.4	6.4	6.4	6.4	—	—	—	6.4	6.4
Frame Width (in.)										
Over Rails										
Front/Rear	45.3/36.7	45.3/36.7	45.3/36.7	45.3/34.0	45.3/34.0	41.3/34.0	41.3/34.0	41.3/34.0	45.3/36.7	45.3/36.7
Turning Diameter Curb-to-Curb (ft)										
2WD	43.4	43.4	43.4	44.5	51.4	46.0	52.9	59.9	53.8	53.8
4WD	45.0	45.0	45.0	46.2	53.0	—	—	—	55.7	55.7
Track Width (in.)										
Front/Rear										
2WD	63.3/63.9	63.3/64.3	64.4/72.9	64.4/64.9	64.4/64.9	69.7/66.8	69.7/66.8	69.7/66.8	63.3/67.1	N/A/N/A
4WD W101/102	68.6/65.1	68.6/64.9	69.2/69.2	69.2/64.9	69.2/64.9	—/—	—/—	—/—	68.6/67.1	N/A/N/A
SIGN PANEL AREA (in.)	17 X 48.75	17 X 48.75	17 X 48.75	17 X 48.75	17 X 48.75	17 X 48.75	17 X 48.75	17 X 48.75	17 X 85	17 X 85

¹Measured at center line of rear axle. N/A—Not Available at time of publication.

INTERIOR DIMENSIONS

CAB										
Headroom (in.)										
Front H61	39.9	39.9	39.9	39.9	39.9	39.9	39.9	39.9	39.9	39.9
Rear H63	—	—	—	—	—	—	—	—	40.8	40.8
Legroom (in.)										
Front L34	41.7	41.7	41.7	41.7	41.7	41.7	41.7	41.7	41.7	41.7
Rear L51	—	—	—	—	—	—	—	—	37.9	37.9
Shoulder Room (in.)										
Front W3	65.4	65.4	65.4	65.4	65.4	65.4	65.4	65.4	65.4	65.4
Rear W4	—	—	—	—	—	—	—	—	64.9	64.9
Hip Room (in.)										
Front W5	60.0	60.0	60.0	60.0	60.0	60.0	60.0	60.0	60.0	60.0
Rear W6	—	—	—	—	—	—	—	—	59.3	59.3

C/K CHASSIS-CAB

PREFERRED EQUIPMENT GROUPS

Preferred Equipment Groups (PEGs) are convenient option packages that can save your customers money. They would pay appreciably more by buying all the options in a Preferred Equipment Group as individual options. (Savings based on a comparison of Manufacturer's Suggested Retail Price of option packages versus MSRP of individual options purchased separately.) See your 1997 Chevrolet Truck Order Guide and Vehicle Price Schedule for specific information and price.

OPTIONS

These options can be ordered individually in addition to the Preferred Equipment Groups if not already included. See your 1997 Chevrolet Truck Order Guide for specific availability and restrictions. The Option Code is listed in **bold type**.

Air Cleaner, High Capacity	K47
Air Conditioning	C60
Appearance Package (Includes Chrome Grille, Composite Halogen Headlamps and Dual Horns)	V22
Axles, Rear	
3.73	GT4
4.10	GT5
4.56	HC4
4.63	GK9
5.13	HC7
Axle, Rear Locking Differential (N/A 3500 HD)	G80
Axle, Rear Wide Track, 92.2-in. wide (C/K 31003, 31403 only)	GTY
Battery, Heavy-Duty Auxiliary (540 CCA) (N/A 3500 HD or Diesel Engine)	TP2
Cold Climate Package (includes Engine Block Heater)	V10
Convenience Group	
Tilt-Wheel™ and Electronic Speed Control	ZQ3
Defogger, Rear Window	C49
Emissions	
Federal	FE9
Massachusetts/New York	NG1
California	YF5
Federal Emissions Override	NC7
Cal./Mass./N.Y. Emissions Override	NB8
Engines (see Powertrains)	
VORTEC 5700 SFI V8	L31
VORTEC 7400 SFI V8	L29
6.5L V8 Turbo Diesel	L65
Alternative Fuel (LPG and CNG conversion-ready)	KL5
Equipment, Heavy-Duty, available on C/K 31003/31403 11,000 GVW only	F44
Floor Covering, Full-Floor, Rubber, Color-Keyed (req. YE9)	BG9
Carpet (N/A Crew-Cab)	B30
Front Floor Mats (N/A Crew-Cab)	B32
Fuel Tank, Delete (rear-mounted 18-Gallon Capacity, available on C/K31003 and C/K31403 and 3500HD only)	NQZ

Glass, Solar-Ray® Deep-Tinted, (includes Light-tinted rear window when sliding rear window is specified on Crew-Cab only)	AJ1
GVWR:	
8600 lb	C6P
9000 lb	C6U
9200 lb	C6W
10,000 lb	C7A
11,000 lb	C7E
12,000 lb	C7L
15,000 lb	C5B
Keyless Entry, Remote (requires YE9)	AU0
Locks, Power door	AU3
Lamps, Roof Marker (included w/ Dual Rear Wheels R05)	U01
License Plate Bracket, Front	VK3
Marketing packages (see order guide for details):	
Convenience package	R9A
Ambulance package	YF2
Mirrors	
Electrochromic (includes light-sensitive rearview mirror and eight-point compass, requires YE9)	DD7
N/A 3500 HD	DD7
Exterior below-eye-line type (LH and RH stainless steel, Mirror head: 9.0" x 6.5") (N/A on Crew Cab) (N/A C3500 HD) (available on C/K 31003, C/K 31403 over 10,000 GVW only)	D45
Exterior Camper Type (LH and RH stainless steel, Mirror head: 7.5" x 10.5")	DF2
Exterior West Coast Type (LH and RH stainless steel, Mirror head: 7.0" x 16.0")	DG5
Paint, Exterior Solid	ZY1
Radio Equipment	
Radio delete (N/A with YE9)	UL5
ETR AM/FM Stereo w/Seek-Scan, Stereo Cassette, Digital Clock	UM6
ETR AM/FM Stereo with Seek-Scan with Automatic Tone Control, Stereo Cassette, Digital Clock,	

TheftLock™ and speed-compensated Volume (includes an enhanced performance speaker system) (N/A with 3500 HD) req. YE9	UL0
ETR AM/FM Stereo with Seek-Scan with Automatic Tone Control, Compact Disk Player, Digital Clock, TheftLock™ and Speed-Compensated Volume (includes an enhanced speaker system) (N/A with 3500 HD) req. YE9	UN0
ETR AM/FM Stereo with Seek-Scan with Automatic Tone Control, Compact Disk Player, Cassette, Digital Clock, TheftLock™ and Speed-Compensated Volume (includes an enhanced performance speaker system) (N/A with 3500 HD) req. YE9	UP0
Seat Type	
Bench Seat	A52
60/40 Reclining Split Bench Seat (N/A 3500HD)	AE7
Reclining High-Back Bucket Seat (includes center console except w/YF2)	A95
Seat, Power Driver's (Crew-Cab model with YE9)	AG9
Skid Plate (4WD models only)	NZZ
Snow Plow Prep Package (4WD Reg. Cab only)	VYU
Springs (torsion bars), Front Heavy-Duty (4x4 only)	F60
Stabilizer Shaft, Rear (C/K 31003, 31403 only)	F61
Tow Hooks, Front (4 x 2 only)	V76
Transfer Case, Electronic Shift Control (reqs ZQ3 or YE9)	NP1
Transmissions	
5-Speed Manual with Deep Low Overdrive, HD	MW3
Electronically Controlled 4-Speed Automatic, Overdrive, HD	MT1
Wheels	
Rally Trim (N/A C3500 HD)	P06
Dual Rear	R05
Single Rear	R04
Windows, Sliding Rear	A28

TIRES

KEY: ALS = ALL-SEASON SBR = STEEL-BELTED RADIAL PLY BW = BLACKWALL HWY = HIGHWAY OOR = ON-OFF ROAD

TIRE DESCRIPTION		FRONT	REAR	SPARE
LT215/B5R16D	HWY/SBR/BW	XYK	YYK	ZYK
LT215/B5R16D	OOR/SBR/BW	XYL	YYL	ZYL
LT225/75R16D	ALS/SBR/BW	XHP	YHP	ZHP
LT225/75R16D	OOR/SBR/BW	XHR	YHR	ZHR
LT245/75R16E	ALS/SBR/BW	XHH	YHH	ZHH
LT245/75R16E	OOR/SBR/BW	XGK	YGK	ZGK
225/70R 19.5F (C3500 HD)	HWY/SBR/BW	XTN	YTN	ZTN

C/K CHASSIS-CAB

INTERIOR EQUIPMENT (CONT.)		CHEYENNE (STANDARD)	SILVERADO (YES)
KEY: ■ = Standard, — = Not Included			
DOOR TRIM	Vinyl color-keyed door trim panels with padded insert armrest, map pockets, large easily accessible door handles, and door reflectors. Color-keyed soft vinyl with cloth insert, map pockets with carpet trim, large easily accessible door handles, door reflectors with lights. NOTE: Scotchgard™ Fabric Protection on all cloth panel and trim.	■ —	— ■
DOORS	Side-door guard beams.	■	■
DOOR LOCKS	Power.	—	■
DRIVER'S CONVENIENCE GROUP	Speed Control, Tilt-Wheel™.	—	■
FLOOR COVERING	Embossed color-keyed rubber mat on Regular-Cab models. Rubber mat is black on Crew-Cab models. Color-keyed carpeting with removable color-keyed rubber floor mats. NOTE: Scotchgard™ Fabric Protector on all cloth floor coverings.	■ —	— ■
GAGES	Include fuel level, odometer, oil pressure, speedometer, telltale lights, engine temperature, voltmeter and tachometer.	■	■
GLOVE BOX	Latched door with light.	■	■
HEADLINER	Cloth with matching retainer moldings, color-keyed.	■	■
HEADLAMP WARNING TONE	Headlamps on.	■	■
HEATER	Includes heater with windshield and side window defogger.	■	■
HEATER DUCT	Rear seat area. Located on floor under front seats (Crew-Cab models only).	■	■
INSULATION	Provided on dash panel, cowl top and sides, and doors. Extra insulation is provided with diesel engines. Plus insulation on headliners. Plus insulation on Regular-Cab panels.	■ — —	■ ■ ■
LIGHTING	Includes dome, reading, ashtray and glove box.	■	■
MIRRORS	10-inch rearview. 10-inch rearview. Electrochromic (Crew-Cab Model only)	■ —	■ ■
RADIOS	ETR AM/FM stereo with Seek-Scan and digital clock. Includes two 6" diameter front door-mounted speakers and two 4" x 6" rear-mounted speakers located at rear above door (4 speakers in all). ETR AM/FM stereo with Seek-Scan, digital clock, cassette. Includes two 6" diameter front door mounted speakers, and two 4" x 6" rear-mounted speakers located at rear above door (4 speakers in all).	■ —	— ■
SEATS	Regular-Cab: Front 3-passenger bench with head restraints and folding backrest. Regular-Cab: Front 3-passenger bench with head restraints and folding center armrest. Power lumbar and front seat-back storage pockets included. Center armrest provides lift-up storage space that features a coin holder, a map strap on the inside lid and a writing board. Crew-Cab: Front 3-passenger bench with head restraints and folding backrest and rear 3-passenger bench with folding backrest. Crew-Cab: Front 3-passenger bench with head restraints and folding center armrest. Power lumbar and front seat-back storage nets included. Center armrest provides lift-up storage space that features a coin holder, a map strap on the inside lid and a writing board. Also includes rear 3-passenger bench with folding backrest. NOTE: Scotchgard™ Fabric Protector on all cloth seats and cloth door trim panels.	■ — ■ — —	— ■ — — ■
STEERING WHEEL	Simulated leather. Leather.	■ —	— ■
STORAGE TRAY	Full width behind seat on floor (N/A 3500HD).	—	■
SUNSHADES	Color-keyed RH and LH padded with cloth covering, storage strap on LH unit and visor mirror on RH unit. Crew-Cab: Padded, color-keyed RH and LH sunshades with extenders and illuminated mirrors. LH sunshade has storage strap.	■ —	■ ■
TOOLS	Mechanical jack and wheel wrench located behind front seat or on rear compartment floor (N/A 3500HD).	■	■
WINDOWS	Power.	—	■
WINDSHIELD WIPERS	Intermittent.	■	■

C/K CHASSIS-CAB

CHASSIS EQUIPMENT (CONT.)			
KEY: ■ = Standard, — = Not Included		CHEYENNE (STANDARD)	SILVERADO (YE9)
SHOCK ABSORBERS	Front: 35mm; Rear: 32mm (35mm on C3500 HD).	■	■
STABILIZER BAR	4x2: Front 1.25". 4x4: Front 1.18".	■	■
STEERING	Integral power. Speed-sensitive (E.V.O.) steering. (E.V.O. N/A 3500HD)	■	■
SUSPENSION, FRONT	4x2: Independent with computer-selected coil springs (I-beam/leaf springs on C3500 HD). 4x4: Independent with computer-selected torsion bars.	■	■
SUSPENSION, REAR	Semi-elliptic two-stage multileaf springs on C/K 20903 models. Semi-elliptic two-stage multileaf springs main/auxiliary on C/K 3500 models. (No auxiliary on C3500 HD).	■	■
TOW HOOKS	Two front on 4x4s.	■	■
EXTERIOR EQUIPMENT			
FRONT BUMPER	Bright appearance. Bright appearance w/black rub strip and bright trim.	■ —	— ■
GLASS	Solar-Ray® tinted glass.	■	■
GRILLE	Molded plastic painted argent with argent air intake areas. Deluxe front appearance package with bright grille and bright trim with argent air intake areas.	■ —	— ■
HEADLAMPS	Single rectangular halogen. Composite halogen.	■ —	— ■
HORN	Single electric low-note. Dual low- and high-note (standard C3500 HD).	■ —	— ■
INSULATION	Hood and cab-to-fender.	—	■
LAMPS	Center high-mounted stop lamp/cargo lamp (N/A on 3500HD). Five amber roof marker lamps on dual rear-wheel models only. Underhood (Fixed).	■ ■	■ ■
MIRRORS	RH and LH below-eyeline type, painted black. Head size 8.5" x 5.0." RH and LH electric below-eyeline type, painted black. Head size 8.5" x 5.0" Models over 10,000lb GVWR use 9.0" x 6.5" mirrors.	■ — ■	— ■ ■
RUNNING LAMPS	Daytime.	■	■
SPARE TIRE AND WHEEL	Full-size (20903 and 30903 models only).	■	■
SPARE TIRE CARRIER	Winch-type carrier mounted under frame at rear (20903 and 30903 models only).	■	■
TIRES	Four on single rear-wheel models and six on dual rear-wheel models. C/K 20903, C/K 30903 and C/K 30943 w/R04: LT245/75R16E. C/K 3500 w/R05: LT225/75R16 C/D. 3500 HD: 225/70R 19.5F (See Order Guide for details.)	■	■
WHEELS	Silver-painted steel wheels with black hub ornament. C/K 20903, C/K 30903 and C/K 30943 w/R04: 16.0" x 6.5" C/K 3500 w/R05: 16.0" x 6.0" 3500 HD: 19.5" x 6.0" Rally wheel trim. Crew-Cab: Rally trim.	■ — —	— ■ ■
WHEEL OPENING FLARES	Front (4WD models over 8600# and C3500HD)	■	■
WIRING	Eight-wire harness for trailering purposes (20903 and 30903 models only).	■	■
INTERIOR EQUIPMENT			
AIR CONDITIONING	Front.	—	■
ARMRESTS	RH and LH padded integral with door panels.	■	■
ASSIST HANDLES	Passenger side.	■	■
CAB BACK PANELS	Color-keyed carpet.	—	■
CIGARETTE LIGHTER	Located on instrument panel. Includes ashtray light and two covered auxiliary power outlets.	■	■
CUPHOLDERS	Two located in dash.	■	■
DOME LAMP	Switch in LH and RH door jamb (two lamps with front door-actuated switches on Crew-Cab). Dome lamp includes delayed illuminated entry feature. Crew-Cab includes switches in all doors.	■ —	■ ■

C/K CHASSIS-CAB

TRANSMISSIONS		
	MANUAL 5-SPEED W/OD, HD (NV4300)	ELECTRONICALLY CONTROLLED AUTOMATIC 4-SPEED W/OD AND TORQUE CONVERTER CLUTCH, HD (HM4L80-E)
Order Code	MW3	MT1
Availability	All Models	All Models
Synchronized Speeds	1/2/3/4/5	---
Gear Ratios		
First	5.61	2.48
Second	3.04	1.48
Third	1.67	1.00
Fourth	1.00	0.75
Fifth	0.75	---
Reverse	5.04	2.08
Power Take-Off	Yes	No

REAR AXLES										
Make	American Axle									Dana
Capacity (lb)	6000 Semi-Floating		6084 Full-Floating		7500 Full-Floating		8600 Full-Floating		11,000 Full-Floating	
Availability	C/K20903		C/K30903- 30943 W/R04		C/K30903- 30943 W/R05		C/K31003-31403		C3500 HD	
Pinion & Ring Gear Type	Hypoid		Hypoid		Hypoid		Hypoid		Hypoid	
Axle Ratio Code	GT4	GT5	GT5	GT5	HC4	GT4	GT5	HC4	GK9	HC7
Ratio	3.73	4.10	4.10	4.10	4.56	3.73	4.10	4.56	4.63	5.13
Pinion Teeth	11	10	10	10	9	11	10	9	8	7
Ring Gear Teeth	41	41	41	41	41	41	41	41	37	37
Ring Gear Diameter (in.)	9.5	9.5	10.5	10.5	10.5	10.5	10.5	10.5	11.5	11.5

Note: Axle Ratio depends on model, powertrain and emissions selected.

FRONT AXLE (K MODELS)						
Make	American Axle					
Capacity (lb)	4250			4500		
Availability	K20903/K30903			K31003/31403/30943		
Pinion and Ring Gear Type	Hypoid			Hypoid		
Ratio	3.73	4.10	4.56	3.73	4.10	4.56
Pinion Teeth	11	10	9	11	10	9
Ring Gear Teeth	41	41	41	41	41	41
Ring Gear Diameter (in.)	9.25	9.25	9.25	9.25	9.25	9.25
Differential Type Bearings, Type	2-Pinion Tapered Roller			2-Pinion Tapered Roller		
Lubricant Capacity (pints)	4.9			4.9		

Note: Axle Ratio depends on model, powertrain and emissions selected.

TRIM LEVELS

Chevrolet offers all Chassis-Cabs in two trim levels, "Cheyenne" and "Silverado." The following chart details major standard features. See your 1997 Chevrolet Truck Order Guide for more details.

CHASSIS EQUIPMENT		CHEYENNE (STANDARD)	SILVERADO (YES)
KEY: ■ = STANDARD, --- = NOT INCLUDED			
BRAKES	Power-assisted, front disc, rear drum; self-adjusting. Four-wheel anti-lock system. Includes brake/transmission interlock.	■	■
EXHAUST	Single. Aluminized stainless steel.	■	■
FRAME	All-welded ladder type, channel design and boxed front-end section. Section modulus (cu in.): C/K20903/30903: 2WD-5.26 cu in.; 4WD-5.25 cu in. C/K31003/31403: 2WD-6.47 cu in.; 4WD-6.76 cu in. 3500 HD: 9.75 cu in. Crew-Cab: 7.49 cu in.	■	■
FUEL TANK	34.0 gallon (approx.) capacity on C/K 20903, 30903 and Crew-Cab models. 40.0 gallon (approx.) capacity on C/K 31003, 31403 and 3500 HD. (Dual tank design, including 22 gallon side fuel tank and 18 gallon rear fuel tank.)	■	■
REAR AXLE	Full-floating on C/K 3500 models. Semi-floating on C/K 20903.	■	■

C/K CHASSIS-CAB

SERIES	MODEL NUMBER/ BODY CODE/ OPTION CODE	PASSENGER CAPACITY (STD./OPT.)	STANDARD ENGINE/ TRANS.	OPTIONAL ENGINE/ TRANS.	GVWR (LB)	GAWR (LB) FRONT/ REAR	BASE PAYLOAD (LB)	MAXIMUM TRAILER WT./ TONGUE LOAD (LB) PROPERLY EQUIPPED	MAXIMUM TRAILER WT./ KINGPIN LOAD (LB) PROPERLY EQUIPPED
FOUR-WHEEL-DRIVE MODELS									
K2500 REGULAR-CAB									
SINGLE REAR WHEELS	CK20903/ ZW9	3/2	5700 V8/M5	5700 V8/A4 7400 V8/M5/A4 6.5L V8/M5/A4	8600	4250/6000	3815	7500/900 10000/1000 8000/950	7500/2500 10500/2000 8000/2000
K3500 REGULAR-CAB									
SINGLE REAR WHEELS	CK30903/ ZW9/ YK or YHH	3/2	5700 V8/M5	5700 V8/A4 7400 V8/M5/A4 6.5L V8/M5/A4	9200	4250/6084	4352	7000/850 10000/1000 7500/900	7000/3000 10000/3000 7500/3000
DUAL REAR WHEELS	CK30903/ ZW9/R05	3/2	5700 V8/M5	5700 V8/A4 7400 V8/M5/A4 6.5L V8/M5/A4	10000	4250/7500	*	7000/850 10000/1000 7500/900	7000/3000 12000/3000 7500/3000
K3500 REGULAR-CAB									
DUAL REAR WHEELS, "STRAIGHT FRAME"	CK31003/ ZW9/F44	3/2	5700 V8/M5	5700 V8/A4 7400 V8/M5/A4 6.5L V8/M5/A4	12000	4500/8600	6666	7000/850 10000/1000 7500/900	7000/3000 12000/3000 7500/3000
DUAL REAR WHEELS, "STRAIGHT FRAME", LWB	CK31403/ ZW9/F44	3/2	5700 V8/M5	5700 V8/A4 7400 V8/M5/A4 6.5L V8/M5/A4	12000	4500/8600	6617	7000/850 10000/1000 7500/900	7000/3000 12500/3000 7500/3000
K3500 CREW-CAB									
SINGLE REAR WHEELS	CK30943/ ZW9	6/5	5700 V8/M5	5700 V8/A4 7400 V8/M5/A4 6.5L V8/M5/A4	9200	4500/6084	3658	6500/800 10000/1000 7500/900	6500/3000 10000/3000 7500/3000
DUAL REAR WHEELS	CK30943/ ZW9/R05	6/5	5700 V8/M5	5700 V8/A4 7400 V8/M5/A4 6.5L V8/M5/A4	10000	4500/7500	*	8000/950 10000/1000 7500/900	8000/3000 12000/3000 7500/3000

*Please refer to the Weights section at the back of the Tech Guide to determine optional payloads.

POWERTRAINS

Chevrolet offers a variety of engines, transmissions and rear axle ratios for the C/K Chassis-Cab. The following charts detail basic engine, transmission and axle specifications. See your 1997 Chevrolet Truck Order Guide for details.

	ENGINES		
	VORTEC 5700 V8 HD	VORTEC 7400 V8 HD	6.5L V8 TURBO DIESEL HD
Order Code	L31	L29	L65
Availability	At or Under 10,000 GVW	Above 10,000 GVW	All Models
SAE Net Horsepower @ rpm	255 @ 4600	250 @ 4200	190 @ 3400
SAE Net Torque lb-ft @ rpm	330 @ 2800	330 @ 2800	385 @ 1800
Fuel System	SFI	SFI	Indirect Fuel Injection
Clutch Size (in.)	12	12	12
Standard Battery Cold Cranking Amps @ 0°F	600	600	2 @ 600 each
Standard Alternator Maximum Capacity (Amps)	100	124	100

C/K CHASSIS-CAB

MODEL SELECTION SUMMARY

Use the chart below to choose the model that fits your customer's needs. Please note that the Base Payloads shown reflect the maximum allowable weight of cargo that can be carried in a standard model, including occupants. (They are calculated by subtracting curb weight from the GVWR.) To calculate payloads for models with optional equipment, please refer to the WEIGHTS section in the back of this book or consult your 1997 GM PROSPEC. Also, the Maximum Trailer Weights shown below are based on vehicles that are properly equipped. See your Chevrolet Truck Order Guide for specific details.

SERIES	MODEL NUMBER/ BODY CODE/ OPTION CODE	PASSENGER CAPACITY (STD./OPT.)	STANDARD ENGINE/ TRANS.	OPTIONAL ENGINE/ TRANS.	GVWR (LB)	GAWR (LB) FRONT/ REAR	BASE PAYLOAD (LB)	MAXIMUM TRAILER WT./ TONGUE LOAD (LB) PROPERLY EQUIPPED	MAXIMUM TRAILER WT./ KINGPIN LOAD (LB) PROPERLY EQUIPPED
TWO-WHEEL-DRIVE MODELS									
C2500 REGULAR-CAB									
SINGLE REAR WHEELS	CC20903/ ZW9	3/2	5700 V8/M5	5700 V8/A4 7400 V8/M5/A4 6.5L V8/M5/A4	8600	3600/6000	4674	8000/950 10000/1000 8500/1000	8000/3000 11000/2500 8500/2500
C3500 REGULAR-CAB									
SINGLE REAR WHEELS	CC30903/ ZW9/ YGK or YHH	3/2	5700 V8/M5	5700 V8/A4 7400 V8/M5/A4 6.5L V8/M5/A4	9000	3600/6084	4533	7500/900 10000/1000 8000/950	7500/3000 10500/3000 8000/3000
DUAL REAR WHEELS	CC30903/ ZW9/R05	3/2	5700 V8/M5	5700 V8/A4 7400 V8/M5/A4 6.5L V8/M5/A4	10000	3600/7500	*	9000/1000 10000/1000 8000/950	9000/3000 12500/3000 8000/3000
DUAL REAR WHEELS, "STRAIGHT FRAME"	CC31003/ ZW9	3/2	5700 V8/M5	5700 V8/A4 7400 V8/M5/A4 6.5L V8/M5/A4	10000	3880/7500	5121	9000/1000 10000/1000 8000/950	9000/3000 12500/3000 8000/3000
DUAL REAR WHEELS, "STRAIGHT FRAME"	CC31003/ ZW9/F44	3/2	5700 V8/M5	5700 V8/A4 7400 V8/M5/A4 6.5L V8/M5/A4	11000	4100/8250	*	9000/1000 10000/1000 8000/950	9000/3000 12500/3000 8000/3000
DUAL REAR WHEELS, "STRAIGHT FRAME", LWB	CC31403/ ZW9	3/2	5700 V8/M5	5700 V8/A4 7400 V8/M5/A4 6.5L V8/M5/A4	10000	3880/7500	5051	9000/1000 10000/1000 8000/950	9000/3000 12500/3000 8000/3000
DUAL REAR WHEELS "STRAIGHT FRAME", LWB	CC31403/ ZW9/F44	3/2	5700 V8/M5	5700 V8/A4 7400 V8/M5/A4 6.5L V8/M5/A4	11000	4100/8250	*	9000/1000 10000/1000 8000/950	9000/3000 12500/3000 8000/3000
C3500 HD REGULAR-CAB									
DUAL REAR WHEELS	CC31003/ ZW9/C5B	3/—	7400 V8/M5	7400 V8/A4 6.5L V8/M5/A4	15000	5000/11000	9036	10000/1000 10000/1000	12000/4000 10000/4000
DUAL REAR WHEELS	CC31403/ ZW9/C5B	3/—	7400 V8/M5	7400 V8/A4 6.5L V8/M5/A4	15000	5000/11000	8926	10000/1000 10000/1000	12000/4000 10000/4000
DUAL REAR WHEELS	CC31803/ ZW9	3/—	7400 V8/M5	7400 V8/A4 6.5L V8/M5/A4	15000	5000/11000	8587	10000/1000 10000/1000	12000/4000 10000/4000
C3500 CREW-CAB									
SINGLE REAR WHEELS	CC30943/ ZW9	6/5	5700 V8/M5	5700 V8/A4 7400 V8/M5/A4 6.5L V8/M5/A4	9000	4100/6084	3826	7000/850 10000/1000 8000/950	7000/3000 10500/3000 8000/3000
DUAL REAR WHEELS	CC30943/ ZW9/R05	6/5	5700 V8/M5	5700 V8/A4 7400 V8/M5/A4 6.5L V8/M5/A4	10000	4100/7500	*	8500/1000 10000/1000 8000/950	8500/3000 12500/3000 8000/3000

* Please refer to the Weights section at the back of the Tech Guide to determine optional payloads.

C/K CHASSIS-CAB INTRODUCTION

C/K CHASSIS-CAB

The C/K Chassis-Cab is available in two trim levels: the "Cheyenne" (standard) and the "Silverado" (uplevel).

Changes on the C/K Chassis-Cab for 1997 include:

- New Venture 4500 Manual Transmission (MW3)
 - New Electronic Variable Orifice (E.V.O.) Steering
Reduces low speed and static steering effort
(except 3500HD)
 - 4-speed 4L80-E Automatic Transmission
Enhancements (MT1)
 - Optional Revised Keyless Entry System
 - Three New Exterior Colors (except 31003, 31403
and 31803 w/15000# GVW)
 - DEX-COOL™ Extended Life Engine Coolant
Change interval upgraded to 5 years/150,000
miles
-

HEATER, VENTILATION, AND AIR CONDITIONING 1B-7

RELATIVE HUMIDITY (%)	AMBIENT AIR TEMP		MAXIMUM LOW SIDE PRESSURE		ENGINE SPEED (rpm)	MAXIMUM RIGHT CENTER AIR OUTLET TEMP		MAXIMUM HIGH SIDE PRESSURE	
	'F	'C	PSIG	kPaG		'F	'C	PSIG	kPaG
20	70	21	24	165	2000	44	7	285	1965
	80	27	25	172		45	7	290	2000
	90	32	28	193		49	9	314	2165
	100	38	28	193		50	10	320	2206
30	70	21	25	172	2000	43	6	287	1979
	80	27	26	179		45	7	293	2020
	90	32	28	193		50	9	320	2206
	100	38	31	214		53	12	328	2262
40	70	21	25	172	2000	45	7	290	2000
	80	27	28	193		49	9	315	2172
	90	32	28	193		51	11	325	2241
	100	38	37	255		59	15	361	2489
50	70	21	26	179	2000	45	7	290	2000
	80	27	28	193		50	10	320	2206
	90	32	32	221		54	12	330	2275
	100	38	40	276		64	18	370	2551
60	70	21	27	186	2000	46	8	300	2069
	80	27	28	193		50	10	320	2206
	90	32	36	248		58	14	355	2448
	100	38	45	310		68	20	409	2820
70	70	21	28	193	2000	49	9	315	2172
	80	27	28	193		51	11	325	2241
	90	32	38	262		62	17	363	2503
80	70	21	28	193	2000	50	10	320	2206
	80	27	32	221		54	12	330	2275
	90	32	41	283		65	18	377	2600

T3204

Figure 4—System Performance Test

A/C



•
•



EXTERIOR LAMPS

7-WIRE TRAILERING HARNESS

HOT AT ALL TIMES

WIRE LEADS ARE TO BE SPLICED TO TRAILER WIRING HARNESS OR ATTACHED TO TRAILER WIRE PLUG.

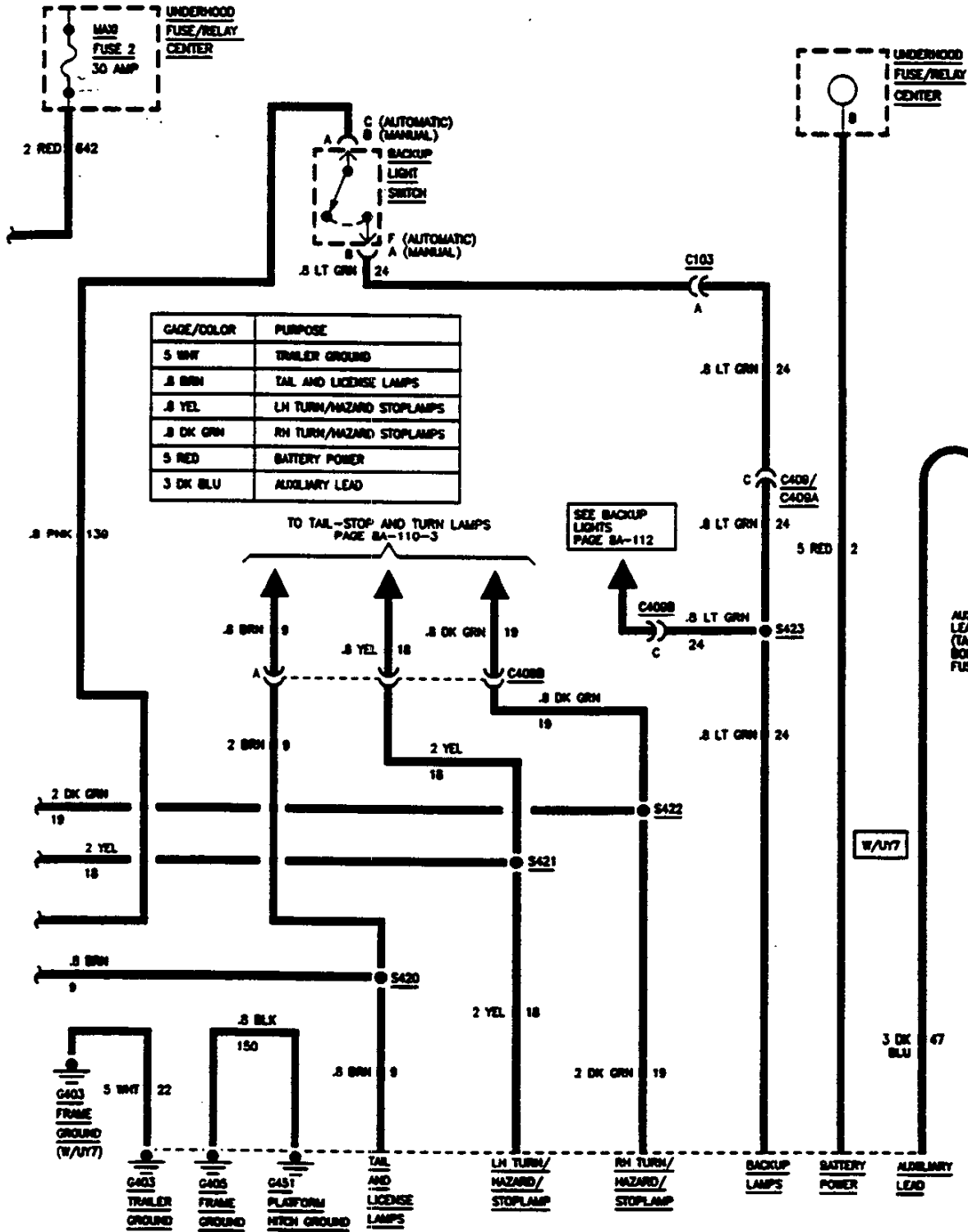



1997 GENERAL MOTORS CORPORATION

INFORMATION REGARDING

CONSUMER INFORMATION TRUCK – CAMPER LOADING

REVISED MARCH 1996



CHEVROLET MOTOR DIVISION
30007 VAN DYKE AVENUE
WARREN, MICHIGAN 48090

GMC

GMC DIVISION
31 E. JUDSON STREET
PONTIAC, MICHIGAN 48342-2230

1997 GENERAL MOTORS TRUCKS

Consumer Information

Truck – Camper Loading

CONSUMER INFORMATION REGULATION 575.103 issued by the National Highway Traffic Safety Administration requires manufacturers of trucks capable of accommodating slide-in camper bodies to provide information concerning proper load and proper load distribution in truck-camper applications.

This Consumer Information booklet is designed to provide basic information relating to load capabilities of 1997 General Motors truck models which are adaptable to slide-in camper applications. Information contained herein is applicable to the truck buyer who already owns a 1997 General Motors truck or to a prospective truck purchaser.

The regulation also provides that proper truck-camper loading information is to be maintained in truck dealerships and be made available to all prospects on request. This booklet relates to the 1997 General Motors truck models recommended for slide-in camper applications and is to be used as a consumer information brochure.

Product specifications or data contained herein may change periodically. When a revision of this booklet is supplied to truck dealers, it is the dealers' responsibility to make the revised information available to the public.

Chevrolet's and GMC's 1988 and newer Full-Size C/K Pickups feature a styling that is more aerodynamic than prior models. Aftermarket manufacturers offer many products, such as slide-in campers, camper shells, and bedliners, designed to fit on the new pickups. However, some products designed for use on Chevrolet Full-Size Pickups, built prior to the 1988 model year or R-V models through the 1991 model year, may not fit in the bed of this vehicle. Please confirm the compatibility of any aftermarket product you intend to install on your new truck by consulting the product manufacturer.

Chevrolet's and GMC's 1994-1997 S/T Series Pickups feature new styling that is more aerodynamic than models from previous years. Some aftermarket items designed for 1993 and earlier S/T Series Pickups may not fit in the bed of this new vehicle. Please consult the product manufacturer for compatibility prior to purchase.

All illustrations and specifications contained in this literature are based on the latest product information available at the time of publication approval. The right is reserved to make changes at any time in prices, colors, materials, equipment, specifications and models, and also to discontinue models.

TRUCK-CAMPER LOADING

Consumer Information Regulation 575.103 requires manufacturers of trucks capable of accommodating slide-in campers to specify the vehicles' Cargo Weight Rating (CWR) and the longitudinal limits within which the center of gravity for the cargo weight rating should be located.

Cargo Weight Rating (CWR)—The cargo weight rating of a vehicle means the value specified by the vehicle manufacturer as the cargo-carrying capacity of a vehicle in pounds, exclusive of (minus) the weight of occupants, computed as 150 pounds times the number of designated seating positions.

Longitudinal Center of Gravity (CG) Zone for CWR—The forward limit of the recommended CG Zone is determined by the application of dimension "A" measured in inches from the rear of the truck bed. The rearward limit of the recommended CG Zone is established by application of dimensions "B", also measured in inches from the rear of the truck bed. The recommended CG Zone lies between these points.

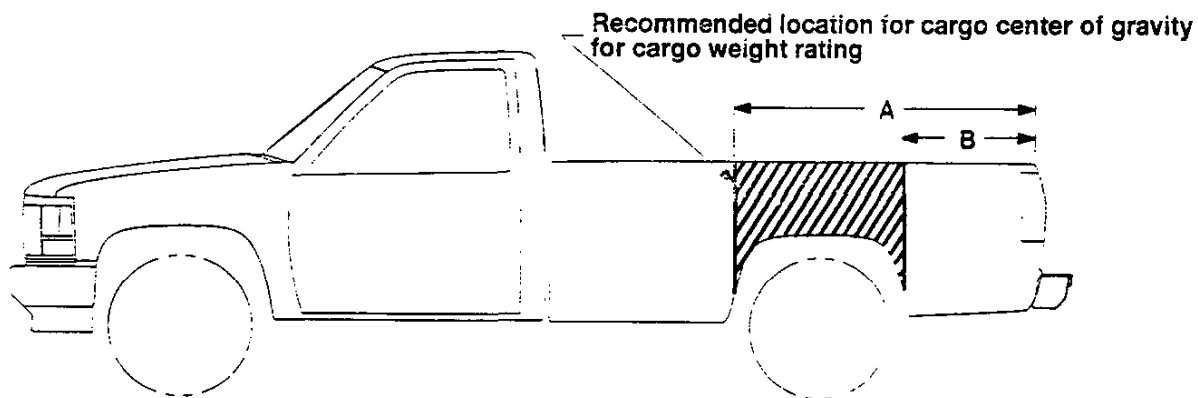

Model _____ Calculated Cargo Weight Rating _____
 Dimension A _____ Dimension B _____

Limitations on Recommended CG Zones

FORWARD LIMIT

- 1) Must not extend beyond the inside surface of the pickup box.
- 2) Must not exceed the front gross axle weight rating (GAWR).

REARWARD LIMIT

- 1) Must be no farther rearward than the inside surface of the pickup box.
- 2) Must not exceed the gross axle weight rating (GAWR) of the rear axle.
- 3) Must not exceed rear axle load limits below:

Series	Rear Axle Load Limits (% of GVWR)
S10/Sonoma 2WD 4600 lb. GVWR 2WD 4900 lb. GVWR	63% 59%
C/K 1500	60%
C/K 2500	65%
C/K 2500/C6P, C/K 3500	70%

Vehicle CG Identification—All General Motors Corporation trucks that may be suitable for carrying a slide-in camper incorporate a Truck-Camper Loading information label located on the glove box floor on C/K and S/T 10/Sonoma models. The vehicle identification number (VIN), the as-manufactured cargo weight rating (CWR) of that vehicle plus the CG limits of dimension "A" and "B" for that vehicle in inches are included.

Vehicle and Truck-Camper Loading are also discussed at length in the Vehicle Owner's Manual.

TRUCK-CAMPER LOADING

Loading Instructions—When the truck is used to carry a slide-in camper, the total cargo load of the truck consists of the manufacturer's camper weight figure, the weight of installed additional camper equipment not included in the camper manufacturer's weight figure, the weight of camper cargo and the weight of passengers *in the camper*. The total cargo load should not exceed the truck's cargo weight rating (CWR) and the camper's center of gravity should fall within the truck's recommended center of gravity zone when installed.

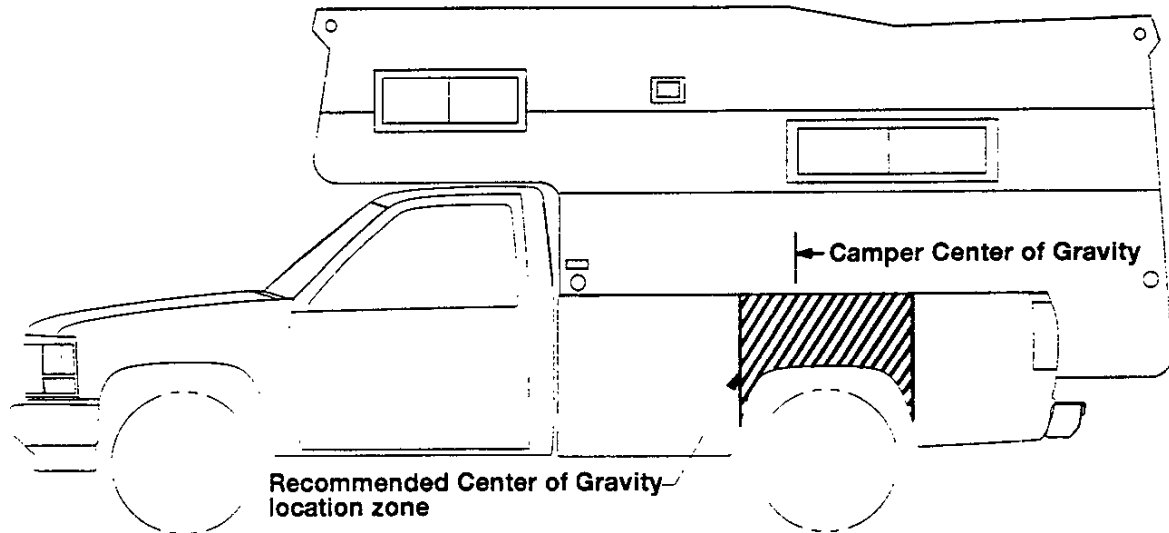

Any accessories or other equipment added to this vehicle, after final date of manufacture, must be weighed or have their weight determined, and the weight deducted from the prescribed cargo weight rating (CWR) of this vehicle. This may decrease the permissible longitudinal zone of the center of gravity for this vehicle.

The longitudinal center of gravity zone has been determined for the full cargo weight rating of this truck. If a slide-in camper has a total weight less than the cargo weight rating (CWR), the permissible longitudinal zone of the center of gravity may be larger. However, individual axle loads should not exceed either of the gross axle weight ratings (GAWR).

Secure loose items to prevent weight shifts that could affect the balance of your vehicle. When the truck camper is loaded, drive to a scale and weigh on the front and on the rear separately to determine the axle loads. Individual axle loads should not exceed either of the gross axle weight ratings (GAWR). The total of the axle loads should not exceed the gross vehicle weight rating (GVWR). These ratings are given on the vehicle identification plate and on the vehicle certification label which are located on the left side of the vehicle, normally on the door latch post or door edge next to the driver. If weight ratings are exceeded, move or remove items to bring all weights below the ratings.

CAUTION: The longitudinal center of gravity is only one of the many factors which may affect the overall performance of a vehicle, including handling, steering and braking. The cargo load should be distributed on both sides of the centerline as equally as possible. The recommended longitudinal limits for the camper's center of gravity are based on the assumption that the vehicle will be operated with reasonable prudence in light of all of the existing conditions. Failure to do so could result in unsatisfactory vehicle performance and could make the vehicle unsafe to operate.

In this connection, refer to any recommendations by the slide-in camper manufacturer regarding installation and loading of the camper.

TRUCK-CAMPER LOADING

DEFINITION OF TERMS

For the purposes of calculating Truck-Camper Loading in this book, listed below are some common terms and abbreviations:

Cargo Weight Rating (CWR)—means the value specified by the vehicle manufacturer as the cargo-carrying capacity of a vehicle in pounds, exclusive of (minus) the weight of occupants, computed as 150 pounds times the number of designated seating positions.

Center of Gravity (CG)—point where the mass of a body is concentrated and if suspended at that point would balance front and rear.

Curb Weight—weight of a vehicle without driver, passengers or cargo but including maximum capacity of fuel, oil, coolant and other items of standard equipment.

Dimension A & B—front and rear limit of Center of Gravity (CG) zone.

Gross Vehicle Weight Rating or 'GVWR' means the value specified by the manufacturer as the loaded weight of a single vehicle.

Gross Axle Weight Rating or 'GAWR' means the value specified by the vehicle manufacturer as the load carrying capacity of a single axle system measured at the tire-ground interfaces.

Model Weight—weight of the vehicle with all items of standard equipment, 150 pounds per passenger in each designated seating position and maximum capacity of fuel, oil and coolant.

Payload Rating is the maximum allowable load (including the weight of the driver and all occupants) that the vehicle can carry based on all factory-installed equipment on the vehicle.

RPO—Regular Production Option.

Slide-in Camper—means a camper having a roof, floor, and sides, designed to be mounted on and removable from the cargo area of a truck by the user.

Weight Distribution—the amount of a vehicle's weight that rests on each axle.

Wheelbase (WB)—the distance from the centerline of the front axle to the centerline of the rear axle.

LIMITATIONS

The following General Motors truck models are not recommended for slide-in camper applications:

- Any pickup model with a cargo weight rating (CWR) of less than 500 lbs. A statement to this effect is imprinted on the Truck-Camper Loading information label which states whether that vehicle is recommended for use with a slide-in camper.
- S 10/Sonoma (2WD) Pickup with 4200 lb. GVWR.
- T 10/Sonoma (4x4) Pickup.
- S/T 10/Sonoma Pickup with 108.3" WB.
- S/T 10/Sonoma Extended Cab Pickup.

Note: C/K 1500 Pickups should not be used for larger, cab-over type slide-in campers.

TRUCK-CAMPER LOADING

S PICKUPS, C/K PICKUPS, EXTENDED/CLUB AND CREW CAB PICKUPS

INSTRUCTIONS FOR PROSPECTIVE TRUCK PURCHASERS VEHICLE SELECTION AND WEIGHT ANALYSIS

1. For S 10/Sonoma Models.

You must order S 10803 (117.9" WB) model with one of the following GVWR Ratings:

S 10803 (2WD)	4600 lb. GVWR	Option C5D
S 10803 (2WD)	4900 lb. GVWR	Option C5A

if you intend to use a slide-in camper on your S 10/Sonoma Pickup. Record the model on page 3. Record the model GVWR, front GAWR, and rear GAWR on page 7. These ratings can be found in the S 10/Sonoma section of the General Motors Light-Duty Truck Data Book or Chevrolet Light-Duty Technical Guide on the Specifications pages. This information is also available in the Chevrolet Spec Manager computer program.

For C/K Models

From the model selection pages of the C/K pickup section of the GMC Light-Duty Truck Data Book, Chevrolet Light-Duty Technical Guide or the Chevrolet Spec Manager System, select the pickup model you desire. Record this information on page 3. Refer to the Specification section for the selected model. Select the GVWR you require and note any minimum tire size and chassis equipment requirements for that GVWR. (To approximate the GVWR you require, add your loaded camper weight to the vehicle curb weight plus the occupants weight at 150 lbs. per designated seating position.) Record the GVWR and the Gross Axle Weight Rating (GAWR), Front and Rear (from the Specifications section), on line 1 of the camper loading worksheet, page 7.

- Record the front and rear curb weights of your selected vehicle on line 2, page 7.
- Record the front and rear passenger weights on line 3, page 7.
- List all factory-installed options you desire, including any options required by your selected GVWR, with their front and rear weights on the Pickup camper loading worksheet on page 7.
- Total the front and rear weights of vehicle model and options to arrive at the total front and rear weight of the vehicle. Follow the directions on page 7, lines 5 through 5C to arrive at the adjusted total vehicle weight.
- Subtract the adjusted total vehicle weight from the GVWR to arrive at the cargo weight rating (CWR) of your truck.* Record this information on page 3.
- Proceed to page 11 and calculate the center of gravity location limits using front and rear GAWRs, cargo weight rating (CWR), and front and rear weight of truck as determined above. Record this information on page 3.

*The addition of any dealer-installed or other accessories will reduce the cargo-carrying capacity by the weight of the equipment installed.

TRUCK-CAMPER LOADING S PICKUPS, C/K PICKUPS

WORKSHEET-CARGO WEIGHT RATING

1. Model GVWR _____ GAWR FRONT _____ REAR _____

2. Curb Weights: FRONT _____ REAR _____

3. Passenger Weights: FRONT _____ REAR _____

4. Other factory-installed options:

..... _____

..... _____

..... _____

..... _____

..... _____

..... _____

..... _____

..... _____

..... _____

..... _____

4a. TOTALS _____

5. Front and Rear Weights _____

5a. Vehicle sub-total weight (add front and rear weight) _____

5b. Add 50 lbs. for all models* -50.0

5c. Adjusted total vehicle weight: _____

6. Vehicle GVWR: _____

Adjusted total vehicle weight (_____)

Cargo Weight Rating _____

Record on page 3.

* If your vehicle is available, drive to a scale and weigh, with occupants, full fuel tank, and other factory-installed options to determine the adjusted total vehicle weight. You will then be able to use your actual total vehicle weight and not have to add the 50#.

TRUCK-CAMPER LOADING DIMENSIONS

S PICKUP

S 10/SONOMA

Long Box (Model S 10803)

	A	B	C	D	E	F	G	H	J	K
Long Box	52.00	40.35	57.91	16.81	36.25	93.3	88.3	56.61	87.6	56.61

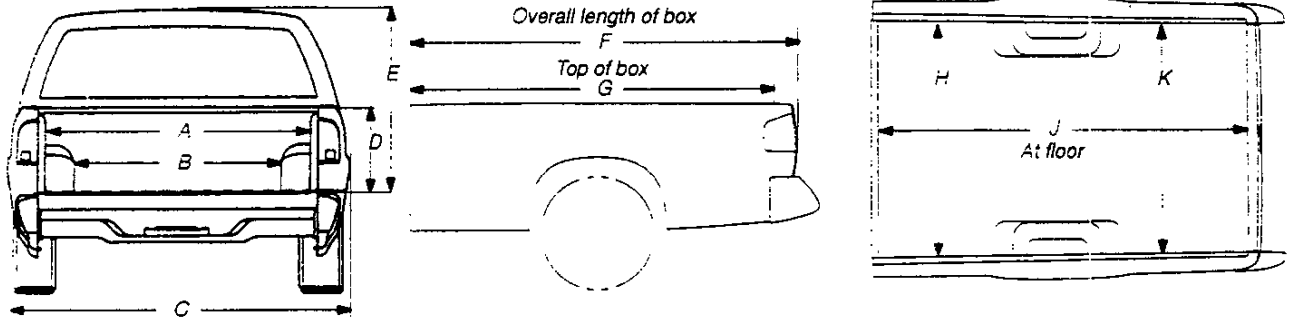

C/K PICKUPS

FLEETSIDE/WIDESIDE

Short Box (Models C/K 10703, 10753, 20753)

Long Box (Models C/K 10903, 10953, 20903, 20953, 30903, 30943, 30953)

	A	B	C	D	E	F	G	H	J	K
Short Box	60.24	49.06	76.75	94.3	19.29	41.44	82.48	63.78	78.66	61.89
Long Box	60.24	49.06	76.75	94.3	19.29	41.44	101.38	63.78	97.56	61.89

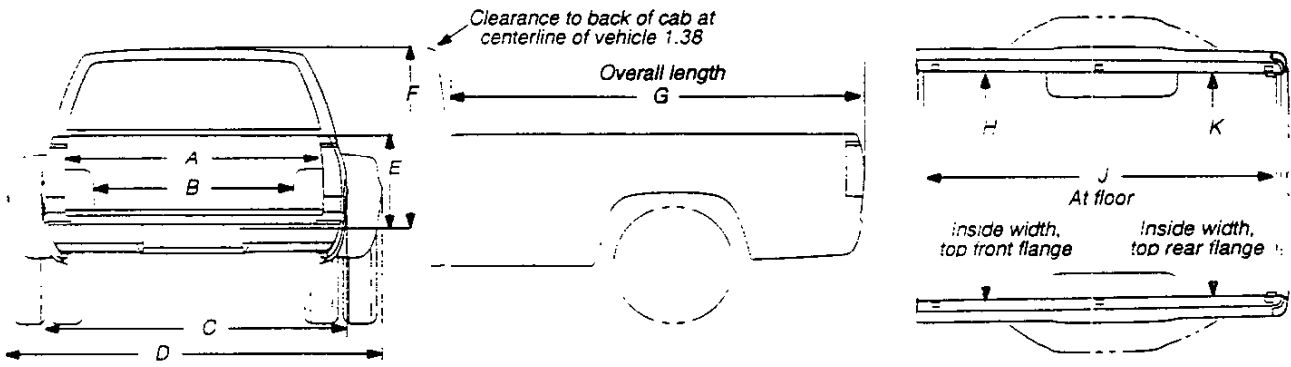

SPORTSIDE *Short Box (Model C/K 10703, 10753&E62)*

	A	B	C	D	E	F	G	H	J
Short Box	49.13	49.13	77.12	19.29	41.44	82.29	49.13	78.7	49.13

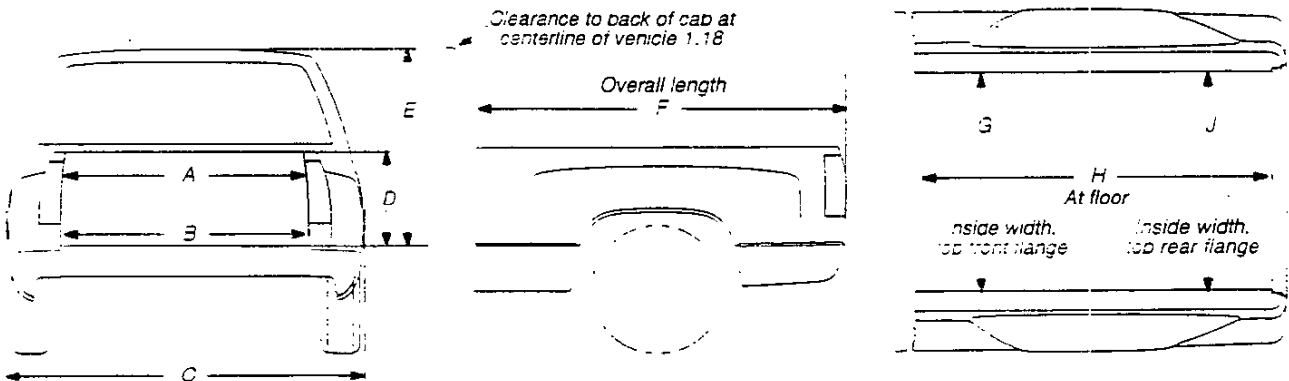

TRUCK-CAMPER LOADING DIMENSIONS

C/K PICKUPS

STANDARD CAB PICKUPS

Short Box (Models C/K 10703)

Long Box (Model C/K 10903, 20903, 30903)

	A	B	C	D	E	F
Short Box	111.0	77.2	35.4	117.5	47.3	200.2
Long Box	111.0	96.1	35.4	131.5	52.2	219.1

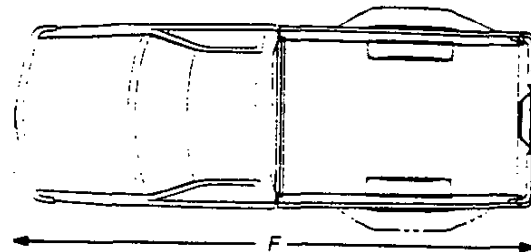
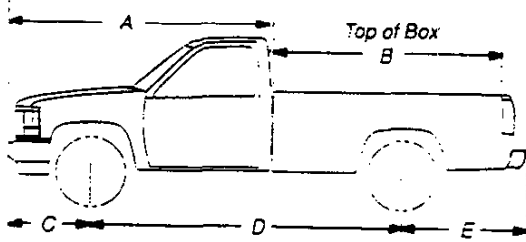

EXTENDED CAB PICKUPS

Short Box (Model C/K 10753, 20753)

Long Box (Model C/K 10953, 20953, 30953)

	A	B	C	D	E	F
Short Box	135.0	77.2	35.4	141.5	47.3	224.2
Long Box	135.0	96.1	35.4	155.5	52.2	243.1

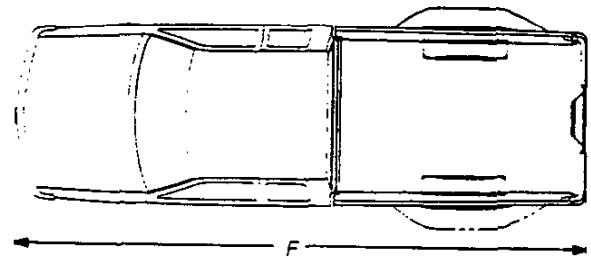
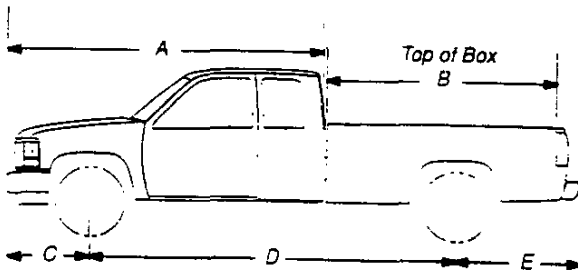

CREW CAB PICKUPS

Long Box (Model C/K 30943)

	A	B	C	D	E	F
Long Box	148.5	96.1	35.9	168.5	52.2	256.6

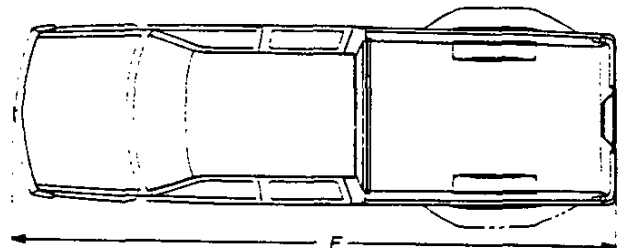
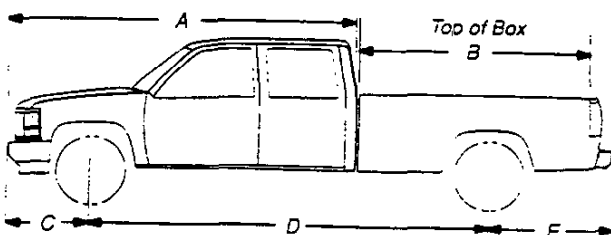

TRUCK-CAMPER LOADING

MODEL CODES AND DIMENSIONS

SERIES	MODEL NUMBER	PICKUP BOX LENGTH	PICKUP STYLE	WB	"C"
--------	--------------	-------------------	--------------	----	-----

REGULAR CAB MODELS

S 10/ Sonoma	S 10803	7.4'	Fleetside/Wideside (E63)	117.9"	42.90"
C/K 1500	C/K 10703	6.5'	Fleetside/Wideside (E63) Sportside (E62)	117.5" 117.5"	38.53" 38.48"
	C/K 10903	8'	Fleetside/Wideside (E63)	131.5"	43.46"
C/K 2500	C/K 20903	8'	Fleetside/Wideside (E63)	131.5"	43.46"
C/K 3500	C/K 30903	8'	Fleetside/Wideside (E63)	131.5"	43.46"

EXTENDED/CLUB CAB MODELS

C/K 1500	C/K 10753	6.5'	Fleetside/Wideside (E63) Sportside (E62)	141.5" 141.5"	38.53" 38.48"
	C/K 10953	8'	Fleetside/Wideside (E63)	155.5"	43.46"
C/K 2500	C/K 20753	6.5'	Fleetside/Wideside (E63)	141.5"	38.53"
	C/K 20953	8'	Fleetside/Wideside (E63)	155.5"	43.46"
C/K 3500	C/K 30953	8'	Fleetside/Wideside (E63)	155.5"	43.46"

CREW CAB MODELS

C/K 3500	C/K 30943	8'	Fleetside/Wideside (E63)	168.5"	43.46"
----------	-----------	----	--------------------------	--------	--------

- Dimension "C" is the distance from the centerline of the rear axle to the end of the pickup box floor.
- Dimension A and B can be calculated by using the formula on page 11.

REGULAR CAB S 10/SONOMA PICKUPS

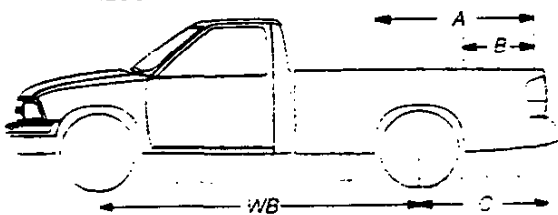

EXTENDED CAB C/K PICKUPS

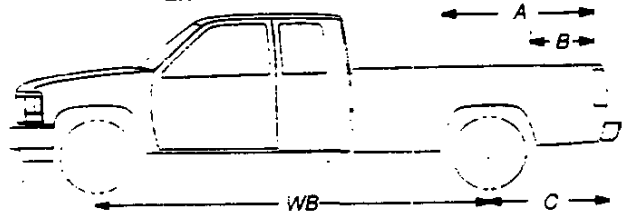

REGULAR CAB C/K PICKUPS

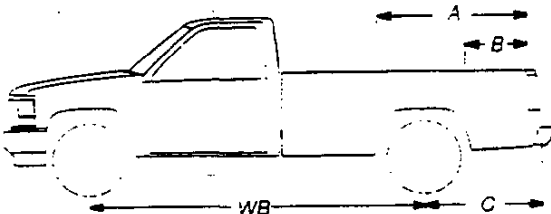

CREW CAB PICKUPS

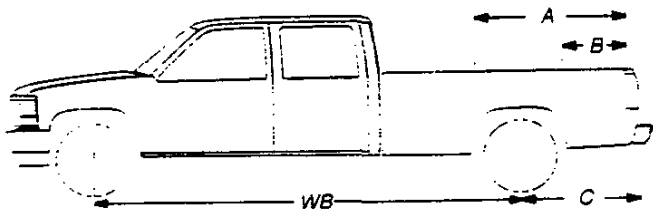

TRUCK-CAMPER LOADING

CALCULATIONS TO DETERMINE FORWARD (A) AND REARWARD (B) LOCATION OF CENTER OF GRAVITY FOR CARGO WEIGHT RATING

Calculations for Dimension A

$$A = \left\{ \frac{\text{Front GAWR} - 1.05 \times \text{Front Weight* of Truck}}{\text{Cargo Weight Rating}} \right\} \times \text{WB} + C$$

Enter Front GAWR	_____
Subtract Front Weight* of Truck x 1.05	- (_____)
Answer	_____
Divide Answer by Cargo Weight Rating (CWR)	÷ _____
Answer	_____
Multiply Answer by Wheelbase (See Chart on page 10)	X _____
Answer	_____
Add C Dimension to Answer (See Chart on page 10)	+C _____
Dimension A (in inches)	= _____
To calculate Dimension A in millimeters, Multiply Dimension A by 25.4	= _____

Note: If "A" is greater than pickup box length, use box length for "A" dimension.

Calculations for Dimension B

$$B = \left\{ 1 - \frac{\text{Rear GAWR} - 1.1 \times \text{Rear Weight* of Truck}}{\text{Cargo Weight Rating}} \right\} \times \text{WB} + C$$

Enter Rear GAWR	_____
Subtract Rear Weight* of Truck x 1.1	- (_____)
Answer	_____
Divide Answer by Cargo Weight Rating (CWR)	÷ _____
Answer	_____
Subtract Answer from 1.000	- (_____)
Multiply Answer by Wheelbase (See Chart on page 10)	X _____
Answer	_____
Add C Dimension to Answer (See Chart on page 10)	+C _____
Dimension B (in inches)	= _____
To calculate Dimension B in millimeters, Multiply Dimension B by 25.4	= _____

Note: If "B" dimension is negative, use 0 (zero) for "B" dimension.

If "B" dimension is greater than "A" dimension, camper usage is not recommended at the Calculated Cargo Weight Rating. Camper usage may be possible for a lighter camper. Substitute known specific camper weight (less than Cargo Weight Rating) for Cargo Weight Rating in calculations above to determine "A" to "B" range for that specific camper.

Record dimension A and B on page 3.

* Front page 7 line 4a.



CHEVROLET MOTOR DIVISION
30007 VAN DYKE AVENUE
WARREN, MICHIGAN 48090

GMC

GMC DIVISION
31 E. JUDSON STREET
PONTIAC, MICHIGAN 48342-2230